

IDS-20a

Icing measurement system

Manual

Setup version 2.27.01 (Firmware 1.66.00)

22.08.2022



Sommer Messtechnik

All rights reserved.

The Copyrights for this manual are exclusively owned by

Sommer Messtechnik
6842 Koblach
Austria

This manual or parts of it may only be copied or passed on to third parties with written permission of Sommer Messtechnik. This applies to printed as well as digital issues of this manual.



Sommer Messtechnik
Strassenhäuser 27
6842 Koblach
Austria
www.sommer.at
E office@sommer.at
T +43 5523 55989
F +43 5523 55989-19

Validity

This manual applies to the Icing measurement system with the setup version 2.27.01, including all its subversions.

Created: 31 Mar 2020

Last update: 22.08.2022



EU conformity



This product is in conformity with the following standards:

| | | |
|----------|-------------|---------------------|
| EMC | 2014/30/EU | EN 301 489-1 V1.9.2 |
| LVD | 2014/35/EU | EN 62311:2008 |
| | | EN 62368-1:2014 |
| RoHS II | 2011/65/EU | |
| RoHS III | 2015/863/EU | |

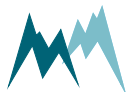

Safety information

Please read this manual carefully before installing or operating this equipment. Non-compliance with the instructions given in this manual can result in failure or damage of the equipment or may put people at risk by injuries through electrical or mechanic impact.

- Make sure that the personnel responsible for installation, configuration and maintenance is familiar with the applicable regulations and standards!
- Do not perform any installations in bad weather conditions, e.g. thunderstorms.
- Prior to installation of equipment inform the owner of the measurement site or the authority responsible for it. Upon completion, secure the installation from trespassers.
- Maintenance and repair must be performed by trained personnel or an engineer of Sommer Messtechnik. Only replacement parts supplied by Sommer Messtechnik should be used for repairs.
- Make sure that NO power is connected to the equipment during installation and wiring!
- Only use a power supply that complies with the power rating specified for this equipment!
- Keep equipment dry during wiring and maintenance!
- If applicable, it is recommended to use accessories of Sommer Messtechnik with this equipment.

Disposal



After this device has reached the end of its lifetime, it must not be disposed of with household waste! Instead, dispose of the device by returning it to a designated collection point for the recycling of waste electrical and electronic equipment.



Feedback

Should you come across any error in this manual, or if you miss information to handle and operate the IDS-20a we are pleased to receive your feedback to office@sommer.at.

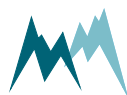

Content

- 1 What is the IDS-20a? 12
- 2 Unpacking 13
- 3 Get started 14
 - 3.1 Connect the IDS-20a to your PC 14
 - 3.2 Configure the IDS-20a 15
 - 3.3 Acquire measurements 15
- 4 How the IDS-20a works 17
 - 4.1 Sensors 17
 - 4.1.1 Cube 1 sensor 17
 - 4.1.2 Cube 5 sensor 18
 - 4.1.3 Rod T 80 sensor 18
 - 4.1.4 T/rH sensor 19
 - 4.2 Controller 19
 - 4.3 Plausibility check 19
 - 4.4 Relay outputs 19
 - 4.5 Data interpretation 20
- 5 Components 24
 - 5.1 MAIN connector 24
- 6 Specifications 25
- 7 Installation 26
 - 7.1 Site selection 26
 - 7.2 Things to consider for installation 26
 - 7.2.1 Power supply 26
 - 7.2.2 Signal cables 26
 - 7.2.3 Lightning protection 27
 - 7.3 Required tools and equipment 27
 - 7.4 Mounting 27
 - 7.5 Wiring 29
 - 7.5.1 RS-485 wiring 29
 - 7.5.2 SDI-12 wiring 29
 - 7.6 Start-up 31
- 8 Operation 32
 - 8.1 Connect device to PC 32
- 9 Maintenance 34
- 10 Support software Commander 35

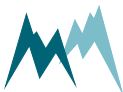

| | | |
|---------|---|----|
| 10.1 | Software features | 35 |
| 10.2 | System requirements | 35 |
| 10.3 | Installation of Commander | 35 |
| 10.4 | Change authorization | 40 |
| 10.5 | Working with connections | 41 |
| 10.5.1 | Establish a connection with the Communication assistant | 41 |
| 10.5.2 | Establish a connection manually | 41 |
| 10.5.3 | Create a new connection | 41 |
| 10.6 | Working with stations | 42 |
| 10.6.1 | Create a station with the Communication assistant | 42 |
| 10.6.2 | Create a station manually | 46 |
| 10.7 | Working with measurements | 47 |
| 10.7.1 | Poll continuous measurements | 47 |
| 10.7.2 | Record measurements | 48 |
| 10.8 | Working with data | 48 |
| 10.8.1 | View live data | 48 |
| 10.9 | Working with spectra | 49 |
| 10.9.1 | Record spectrum | 49 |
| 10.9.2 | Read spectrum file | 49 |
| 10.10 | Working with setups | 50 |
| 10.10.1 | Download setup | 50 |
| 10.10.2 | Open a setup file | 50 |
| 10.10.3 | Edit setup | 50 |
| 10.10.4 | Upload new setup file | 51 |
| 10.11 | Update firmware | 51 |
| 11 | Configuration of the IDS-20a | 53 |
| 11.1 | Software tools | 53 |
| 11.2 | Configuration with Commander support software | 53 |
| 11.3 | Configuration with a terminal program | 56 |
| 11.4 | General settings | 57 |
| 11.4.1 | Language/Sprache | 57 |
| 11.4.2 | Decimal character | 57 |
| 11.4.3 | Units and decimals | 58 |
| 11.4.4 | Output protocol (OP) | 58 |
| 11.4.5 | Information | 58 |
| 11.5 | Sensor setup | 59 |
| 11.5.1 | Sensor type | 59 |
| 11.5.2 | Sensor S1, orientation and Sensor S2, orientation | 59 |
| 11.5.3 | Sensor S1, zero adjust and Sensor S2, zero adjust | 59 |
| 11.5.4 | “OFF” turn off temperature | 59 |

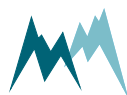

| | | |
|--------|----------------------------|----|
| 11.6 | Heater configuration | 60 |
| 11.6.1 | Ice, maximum | 60 |
| 11.6.2 | Ice, minimum | 60 |
| 11.6.3 | Water, maximum | 60 |
| 11.6.4 | Water, minimum | 60 |
| 11.6.5 | Maximum heating time | 60 |
| 11.6.6 | Cool down duration | 61 |
| 11.6.7 | Meas. duration icing rate | 61 |
| 11.7 | Icing verification | 61 |
| 11.7.1 | Maximum temperature | 61 |
| 11.7.2 | Minimum humidity | 61 |
| 11.7.3 | Maximum water | 61 |
| 11.8 | Relay switching | 61 |
| 11.8.1 | Output value | 62 |
| 11.8.2 | Sensor choice | 62 |
| 11.8.3 | Ice limit | 62 |
| 11.8.4 | Water limit | 62 |
| 11.8.5 | Ice rate limit | 62 |
| 11.8.6 | Functional switch at "OFF" | 62 |
| 12 | Communication | 64 |
| 12.1 | Communication protocols | 64 |
| 12.2 | Data output | 64 |
| 12.2.1 | Main values | 64 |
| 12.2.2 | Special values | 65 |
| 12.2.3 | Analysis values | 65 |
| 12.2.4 | Exception values | 67 |
| 12.3 | RS-485 | 68 |
| 12.3.1 | What is RS-485? | 68 |
| 12.3.2 | What can I do with it? | 68 |
| 12.3.3 | Configuration | 68 |
| 12.3.4 | Data output options | 70 |
| 12.3.5 | Sommer bus protocol (SBP) | 70 |
| 12.3.6 | Standard protocol | 74 |
| 12.3.7 | RS-485 commands | 77 |
| 12.3.8 | Sommer CRC-16 | 79 |
| 12.4 | SDI-12 | 80 |
| 12.4.1 | What is SDI-12? | 80 |
| 12.4.2 | What can I do with it? | 80 |
| 12.4.3 | Configuration | 81 |
| 12.4.4 | Data structure | 81 |
| 12.4.5 | SDI-12 commands | 82 |

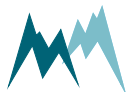

| | | |
|--------|-------------------------------|-----|
| 12.5 | Modbus | 86 |
| 12.5.1 | What is Modbus? | 86 |
| 12.5.2 | What can I do with it? | 86 |
| 12.5.3 | Wiring | 86 |
| 12.5.4 | Modbus configuration | 87 |
| 12.5.5 | Modbus commands and registers | 93 |
| 12.5.6 | Reactivate Sommer protocol | 98 |
| 12.5.7 | PLC integration | 103 |
| 13 | Parameter definitions | 104 |
| A | Relay A | 104 |
| A-A | Output value | 104 |
| A-B | Sensor choice | 104 |
| A-C | Turn off delay | 104 |
| A-D | Ice limit | 105 |
| A-E | Water limit | 105 |
| A-F | Ice rate limit | 105 |
| A-G | Test output | 105 |
| B | Relay B | 105 |
| B-A | Output value | 106 |
| B-B | Sensor choice | 106 |
| B-C | Turn off delay | 106 |
| B-D | Ice limit | 106 |
| B-E | Water limit | 106 |
| B-F | Ice rate limit | 107 |
| B-G | Test output | 107 |
| C | Sensor tests | 107 |
| C-A | Sensor S1, test heating | 107 |
| C-B | Sensor S1, test | 107 |
| C-C | Sensor S2, test heating | 107 |
| C-D | Sensor S2, test | 108 |
| D | Technics | 108 |
| D-A | SDI-12 address | 108 |
| D-B | Measurement Interval | 108 |
| D-C | Units and decimals | 108 |
| | D-C-A Temperature, unit | 109 |
| | D-C-B Temperature, decimals | 109 |
| D-D | SBP device addressing | 109 |
| | D-D-A Device number | 109 |
| | D-D-B System key | 109 |
| D-E | RS-485 (COM) | 110 |
| | D-E-A Output protocol | 110 |
| | D-E-A-A Protocol type | 110 |

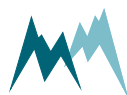

| | | | |
|-------|------------------------|-------------------------------|-----|
| | D-E-A-B | Measurement output | 111 |
| | D-E-A-C | Information | 111 |
| | D-E-A-D | Wake-up sequence | 111 |
| | D-E-A-E | Prefix holdback | 112 |
| | D-E-A-F | MODBUS, set default | 112 |
| | D-E-A-G | MODBUS, device address | 112 |
| D-E-B | Port | | 113 |
| | D-E-B-A | Baud rate | 113 |
| | D-E-B-B | Parity, stop bits | 113 |
| | D-E-B-C | Minimum response time | 114 |
| | D-E-B-D | Transmitter warm-up time | 114 |
| | D-E-B-E | Flow control | 114 |
| | D-E-B-F | Sending window | 114 |
| | D-E-B-G | Receiving window | 115 |
| D-F | Sensor pair | | 115 |
| | D-F-A | Sensor type | 115 |
| | D-F-B | Sensor early heating | 116 |
| | D-F-C | Icing verification | 116 |
| | D-F-C-A | Maximum temperature | 116 |
| | D-F-C-B | Minimum humidity | 116 |
| | D-F-C-C | Maximum water | 116 |
| | D-F-C-D | Switch on delay | 117 |
| | D-F-C-E | Temperature sensor choice | 117 |
| | D-F-D | Limits and timer | 117 |
| | D-F-D-A | Min. sup. voltage for heating | 117 |
| | D-F-D-B | Ice, maximum | 118 |
| | D-F-D-C | Ice, minimum | 118 |
| | D-F-D-D | Ice, swop active sensor | 118 |
| | D-F-D-E | Accumulation maximum | 118 |
| | D-F-D-F | Water, maximum | 118 |
| | D-F-D-G | Water, minimum | 119 |
| | D-F-D-H | Ice rate, heating | 119 |
| | D-F-D-I | Ice rate, minimum | 120 |
| | D-F-D-J | Ice rate, holdtime | 120 |
| | D-F-D-K | Maximum heating time | 121 |
| | D-F-D-L | Subsequent heating, head | 121 |
| | D-F-D-M | Subsequent heating, shaft | 121 |
| | D-F-D-N | Cool down duration | 121 |
| | D-F-D-O | Duration frost suppression | 121 |
| | D-F-D-P | Meas. duration icing rate | 122 |
| D-F-E | Sensor S1, orientation | | 122 |
| D-F-F | Sensor S1 temperature | | 123 |
| | D-F-F-A | Temperature offset | 123 |

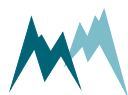

| | | | |
|------------|---------|-------------------------------|-----|
| | D-F-F-B | Adjust temperature | 123 |
| | D-F-F-C | Test temperature | 123 |
| | D-F-G | Sensor S1, zero adjust | 123 |
| | D-F-H | Sensor S1, test | 123 |
| | D-F-I | Sensor S2, orientation | 123 |
| | D-F-J | Sensor S2 temperature | 124 |
| | D-F-J-A | Temperature offset | 124 |
| | D-F-J-B | Adjust temperature | 124 |
| | D-F-J-C | Test temperature | 124 |
| | D-F-K | Sensor S2, zero adjust | 124 |
| | D-F-L | Sensor S2, test | 124 |
| D-G | | Temperature and humidity (TH) | 124 |
| | D-G-A | Humidity offset | 125 |
| | D-G-B | Adjust humidity | 125 |
| | D-G-C | Test humidity | 125 |
| | D-G-D | Temperature offset | 125 |
| | D-G-E | Adjust temperature | 125 |
| | D-G-F | Test temperature | 126 |
| D-H | | Advanced settings | 126 |
| | D-H-A | Sleep mode | 126 |
| | D-H-B | SDI12 'M'-response | 126 |
| | D-H-C | "OFF" turn off temperature | 127 |
| | D-H-D | Functional switch monitoring | 128 |
| | D-H-E | Functional switch at "OFF" | 128 |
| | D-H-F | Sommer ID | 129 |
| D-I | | Measurement table | 130 |
| E | | Region format | 130 |
| | E-A | Language/Sprache | 130 |
| | E-B | Decimal character | 131 |
| F | | Special functions | 131 |
| | F-A | Relay, reset counters | 131 |
| | F-B | Relay, simulate outputs | 131 |
| | F-C | Device status | 132 |
| | F-D | View setup | 132 |
| | F-E | Set factory default | 132 |
| | F-F | Temp. load factory default | 132 |
| | F-G | Relaunch program | 132 |
| Appendix A | | Measurement phases | 133 |
| | A.1 | Sensor status | 133 |
| | A.2 | Icing verification | 133 |
| Appendix B | | Troubleshooting | 136 |

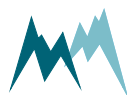

| | | |
|------------|--|-----|
| B.1 | Devices | 136 |
| B.1.1 | The IDS-20a is not responding or returns unreadable characters | 136 |
| B.1.2 | The IDS-20a reboots repeatedly | 138 |
| B.2 | Measurement data | 138 |
| B.2.1 | Measurement data are not updated | 138 |
| B.2.2 | No data from the ice detection sensor are returned | 138 |
| B.3 | Firmware & software | 138 |
| B.3.1 | Commander loads wrong setup | 138 |
| B.3.2 | Firmware update via RS-485 is aborted | 139 |
| B.4 | RS-485 | 139 |
| B.4.1 | Configuration via terminal shows unexpected behavior | 139 |
| B.5 | SDI-12 | 139 |
| B.5.1 | The IDS-20a is not detected by a SDI-12 master device | 139 |
| B.5.2 | Data logger receives no SDI-12 data | 140 |
| B.6 | Modbus | 140 |
| B.6.1 | Modbus function 04 returns obscure measurement values | 140 |
| Appendix C | CRC-16 array | 141 |

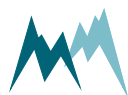

1 What is the IDS-20a?

During the winter season a lot of our infrastructure is affected by icing. In the transportation sector icing may not only impair the proper functioning of engines, sensors and signaling systems but may also pose serious hazards through icy runways and ice accretion on airplanes. Power generation by wind turbines solar- and hydroelectric generators may not be reliable under icy conditions and power transmission may be interrupted by heavy ice loads on power lines. Last but not least, ice on a building or other structure, e.g. antenna, may add a lot of weight and increase the surface area exposed to wind.

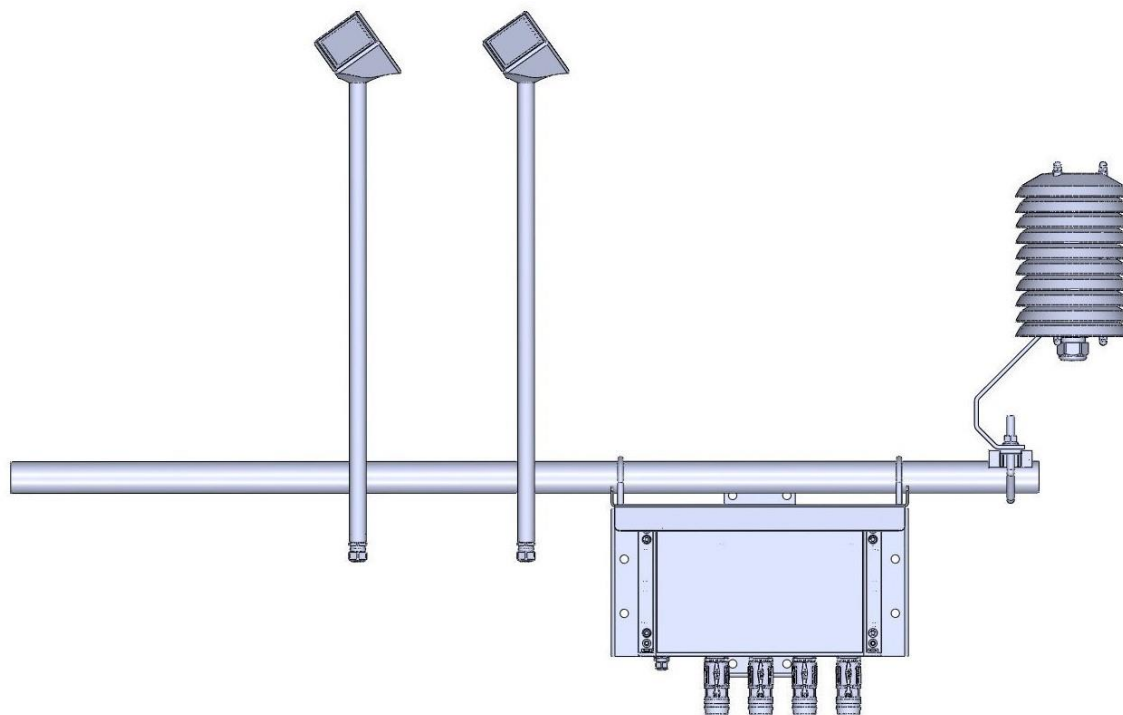

Figure 1 IDS-20a

2 Unpacking

When unpacking your IDS-20a sensor box please make sure that the following items are present:

| Qty | Name |
|-----|--|
| 1 | IDS-20a controller |
| 1 | 2x Cube 1 ice sensor |
| 1 | Temperature and relative humidity probe |
| 1 | Radiation shield |
| 1 | Mounting pole \varnothing 34 x 800 mm |
| 1 | Mounting brackets for controller, sensors and radiation shield |
| 1 | MAIN sensor cable |
| 1 | USB to RS485 isolated converter cable |
| 1 | Manual and Commander Software on USB stick |

In case of missing or damaged items please contact your Sommer Messtechnik sales partner.

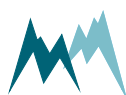

3 Get started

Follow the steps described below to set the basic configurations and to acquire the first measurement results.



NOTE Perform the first start-up in your lab or office before installing the equipment in the field!

3.1 Connect the IDS-20a to your PC

1. Install the Commander support software (see [Installation of Commander](#)).
2. Connect the yellow and gray wires of the sensor cable to the RS-485 to USB converter cable and plug it into your PC as illustrated in the figure below.
3. Connect a 9...28 VDC power supply to the IDS-20a as shown in the figure below.
4. Click on [Communication assistant](#) on the right-hand side of the Commander window and follow the instructions.
 - a. As [Type of connection](#) select [Serial connection](#)
 - b. As [Device type](#) select [Sensor \(9600 Bd\)](#)
 - c. Select [New connection](#) and select the COM port

During this procedure the communication assistant will search for connected devices. Upon successful completion, the new connection is added to the connections list (tab [Connections \(F8\)](#)).

5. In the [Communication](#) section at the right-hand side of the Commander window select Mode [Connection](#) and the previously created connection from the drop-down list.
6. Click [Connect](#) to establish a connection with the IDS-20a. If the connection was successful a green icon is displayed at the top-right corner of the Commander window.
7. Select the tab [Parameters \(F2\)](#) and click [Download parameters from device](#) on the left side of the Commander window. The complete parameter list is transferred from the sensor to your PC and displayed in the [Parameter](#) window.

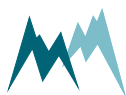

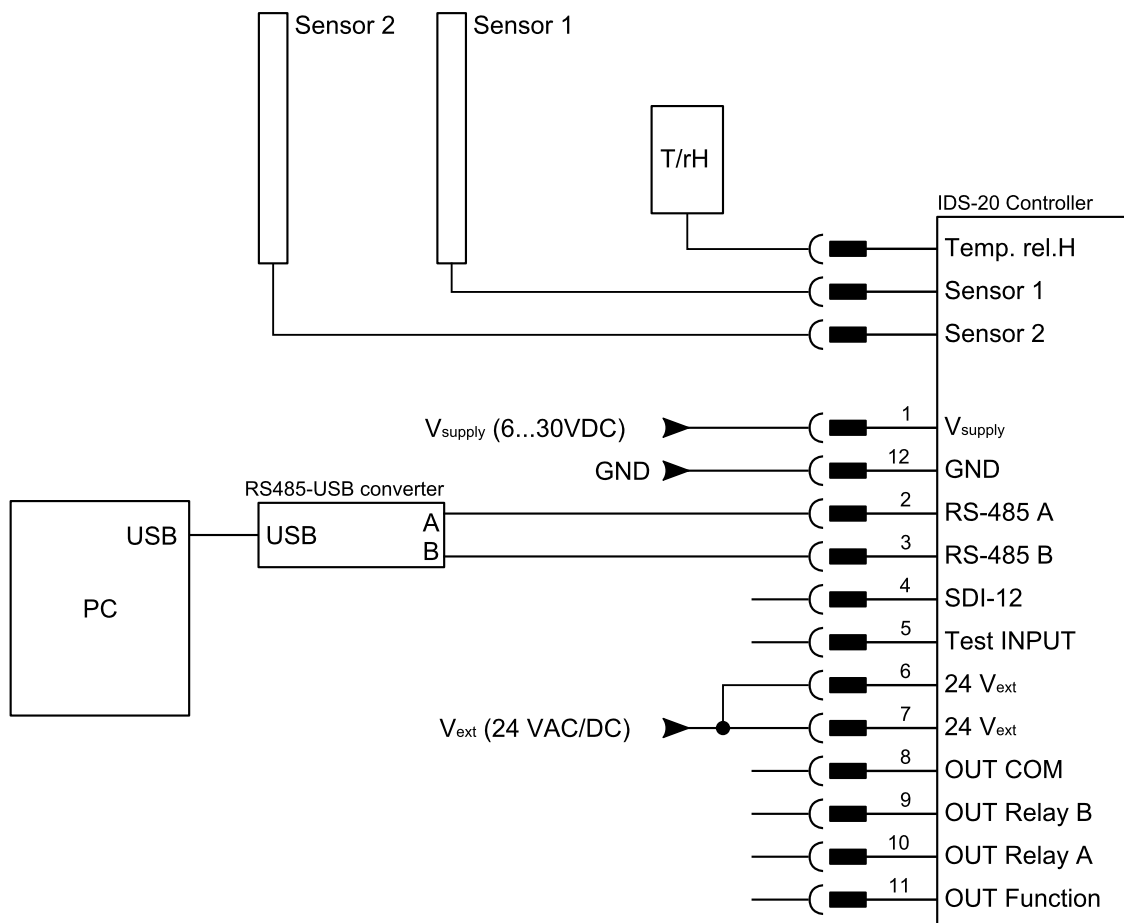

3.2 Configure the IDS-20a

1. Select language, decimal character, units and decimal places (see [General settings](#))
2. Define scope and structure of the data output (see [General settings](#))
3. Set the zero-reading of the sensor (see [Sensor setup](#))
4. Set the limits at which the relays switch (see [Relay switching](#))
5. Send any modifications to the IDS-20a by clicking [Upload modified parameters to device](#).

3.3 Acquire measurements

1. Establish a connection to your device as described in [Working with connections](#).
2. Download the setup of your device as described in [Download setup](#).
3. Select the [Measurement \(F3\)](#) tab.
4. In the [Commands](#) section click [Start polling measurement](#).

5. Select the option **Polling with measurements**. Now, the Commander will trigger measurements of the IDS-20a without any delays between measurements. The results are displayed **Measurement values** and plotted in the **Measurement data graph**.
6. To finish polling mode click **Stop polling**.

The screenshot shows the Commander 1.0.8.10 software interface. The 'Measurement (F3)' tab is active. On the left, the 'Polling commands' section has a red callout box labeled 'Start and stop polling' pointing to the 'Start polling measurements' and 'Stop polling' buttons. The 'Measurement values' table has a red callout box labeled 'Last measurement' pointing to the row with ID 7 (Learned flow, 5.143 m³/h). The 'Measurement data graph' shows a line plot of Flow (m³/h) over time, with a red line representing the current flow measurement. The graph shows a peak in flow around 10:05:00. The 'Self-check' section shows a green checkmark and the message 'Sensor operates normally'. The 'Information' section shows device details for SQ-Xa (0001). The 'Communication' section shows connection settings. The 'Commands' section has 'Connect' and 'Disconnect' buttons. The 'Terminal' section is empty.

Authorization: Expert

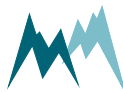

4 How the IDS-20a works

The IDS-20a ice sensor makes use of the different physical characteristics of air, water and ice at varying frequencies of an applied voltage. As illustrated in Figure 2 a single ice-sensor consists of two conductive paths which generate an electric field between them when powered. This electric field is different for air, water and ice. By measuring the resulting complex impedance at different frequencies the volume content of ice, water and air can be detected.

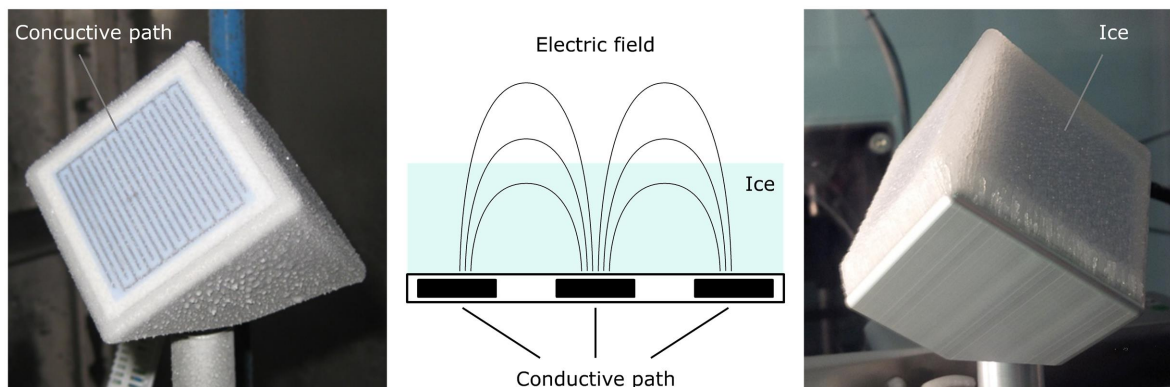

Figure 2 Principle of ice detection

4.1 Sensors

Depending on the application the IDS-20a is available in three versions with different sensor combinations. Figure 3 illustrates these versions.

The IDS-20s contains a single ice-sensor, either the Cube 5 or the Rod T 80. While the first option is primarily used to detect icing events, the latter is applied to monitor heavy ice loads.

The IDS-20a combines two Cube 1 sensors and is mainly applied in aviation. As these two sensors operate intermittently icing events can be detected without any interruption.

The IDS-20ad combines a Cube 5 and Rod T 80 sensor. This versatile system can detect icing events and heavy ice loads and is usually applied in monitoring of buildings and other structures, e.g. antennas or power lines.

4.1.1 Cube 1 sensor

The Cube 1 sensor contains three sensor plates arranged in an angle of 120° to each other. This arrangement allows the determination of the icing direction. The sensor plates can detect water, freezing rain and ice accretion from 0.01 to 1 mm.

The sensor head contains a Pt1000 sensor to monitor the surface temperature of the device. Sensor head and shaft can be heated separately with a 24 VAC/DC power supply.

4.1.2 Cube 5 sensor

The Cube 5 sensor contains three sensor plates arranged in an angle of 120° to each other. This arrangement allows the determination of the icing direction. The sensor plates can detect water, freezing rain and ice accretion from 0.1 to 5 mm.

The sensor head contains a Pt1000 sensor to monitor the surface temperature of the device. Sensor head and shaft can be heated separately with a 24 VAC/DC power supply.

IDS-20s with Cube5 sensor

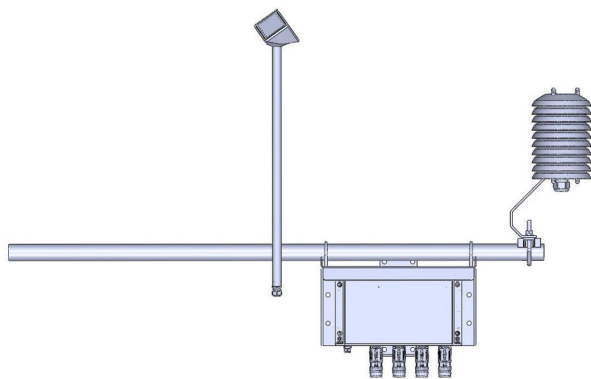

IDS-20s with rod T 80 sensor

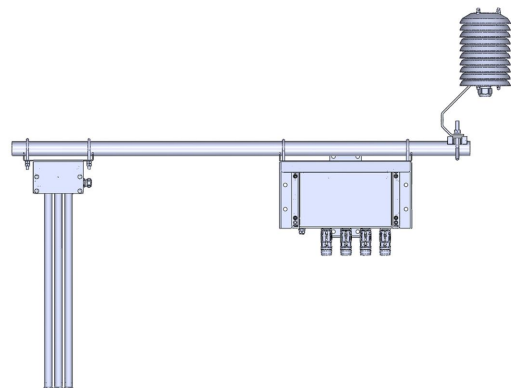

IDS-20c with Cube 1 and Cube 5 sensor

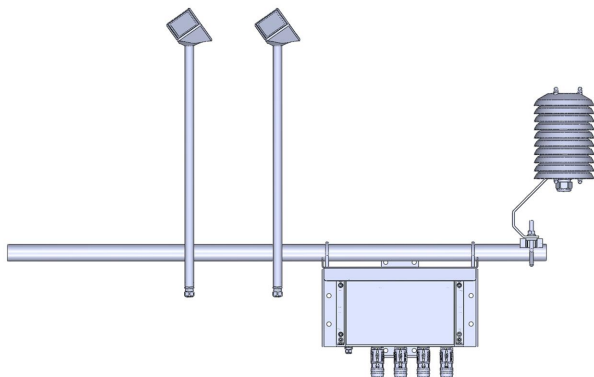

IDS-20d with Cube 5 and rod T 80 sensor

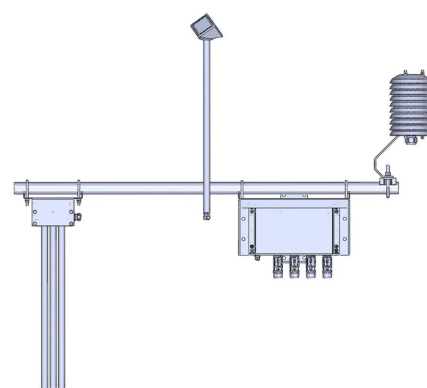

Figure 3 IDS-20a versions

4.1.3 Rod T 80 sensor

The Rod T 80 sensor consists of three metal rods arranged in a triangle. The sensor can detect water, freezing rain and ice accretion from 1 to 80 mm.

The sensor head contains a Pt1000 sensor to monitor the surface temperature of the device. The sensor does not contain a heating option.

4.1.4 T/rH sensor

To validate the icing detected by the ice-sensors an additional T/rH-probe is mounted with the system. See [Plausibility check](#) for details.

4.2 Controller

The ice- and T/rH-sensors are connected to the controller of the IDS-20a which reads and processes the acquired data and controls the sensor heating. It also provides an interface to connect to a data processing device, e.g. PC or data logger, and a power supply.

4.3 Plausibility check

Formation and accretion of ice on a surface depends on specific environmental conditions determined by air temperature, humidity and surface temperature.

The IDS-20a uses the present meteorological conditions to verify the icing measured by the ice-sensors: Parallel to the ice detection the IDS-20a measures the air temperature and humidity and calculates the dew and frost points. With these data the IDS-20a checks if the conditions actually permit the formation of ice as detected by the ice-sensors. Thus, icing events are detected with high reliability.

4.4 Relay outputs

The IDS-20a provides two relay outputs to record the occurrence of icing events or to trigger an action upon ice detection. Both relays can be configured to switch at a specified ice or water layer thickness or icing rate. By doing so, different switching combinations can be selected:

- relay A and B respond to limit values of one sensor, e.g. ice layer thickness and icing rate
- relay A responds to a limit value of sensor 1, e.g. presence of water, and relay B to a limit value of sensor 2, e.g. icing rate
- one relay responds to a limit value of one sensor, e.g. icing rate, and the other is turned off

The IDS-20a contains an additional relay that responds to the state of the device, i.e. switches if the IDS-20a detects an error. The relay output can be configured to either close on proper functioning of the device or if the device detects an error.

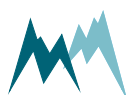

4.5 Data interpretation

Ice forms at certain air and surface temperatures under high humidity levels. In many applications the information of instantaneous icing on a surface is required. In others, the duration and intensity of an icing event is of interest. In the following examples the interaction between atmospheric conditions and the occurrence of icing is illustrated.

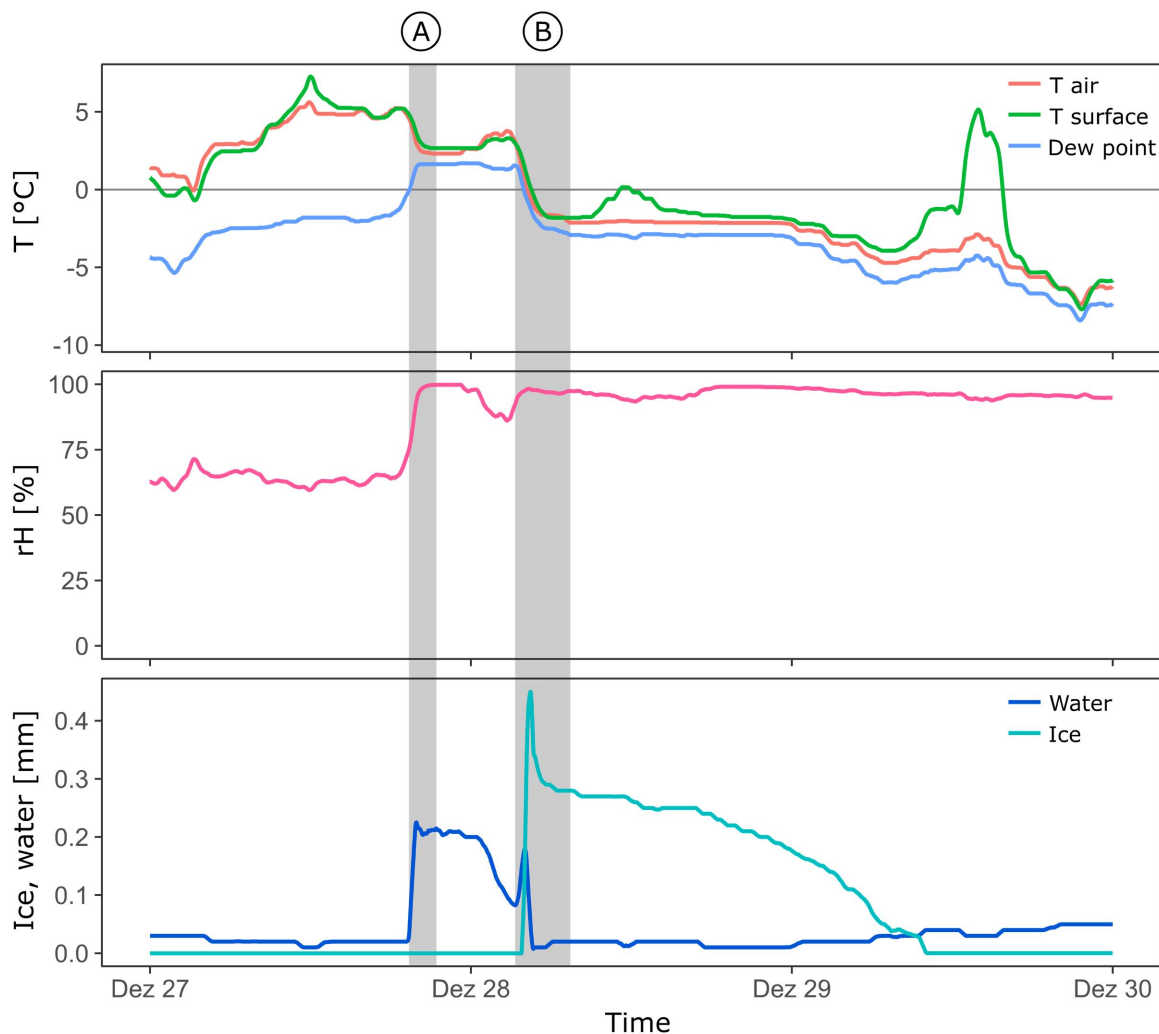

Figure 4 Dew and ice on a Cube 5 sensor

In [Figure 4](#) the formation of water and ice on a Cube 5 sensor is shown. In period A the air and surface temperature of the sensor drop and closely reach the dew point, thus increasing the relative humidity. As a consequence water condenses on the sensor surface as illustrated in the lower plot.

During the early morning hours the air and surface temperature further drop below freezing. This temperature drop first leads to more water condensation and is then followed by a sharp rise in ice formation as the water freezes. Shortly after, the sun rises and transforms the thin ice layer on the

sensor through irradiation. This is visible by a quick drop of the ice thickness. During the day more ice sublimates despite below-zero temperatures.

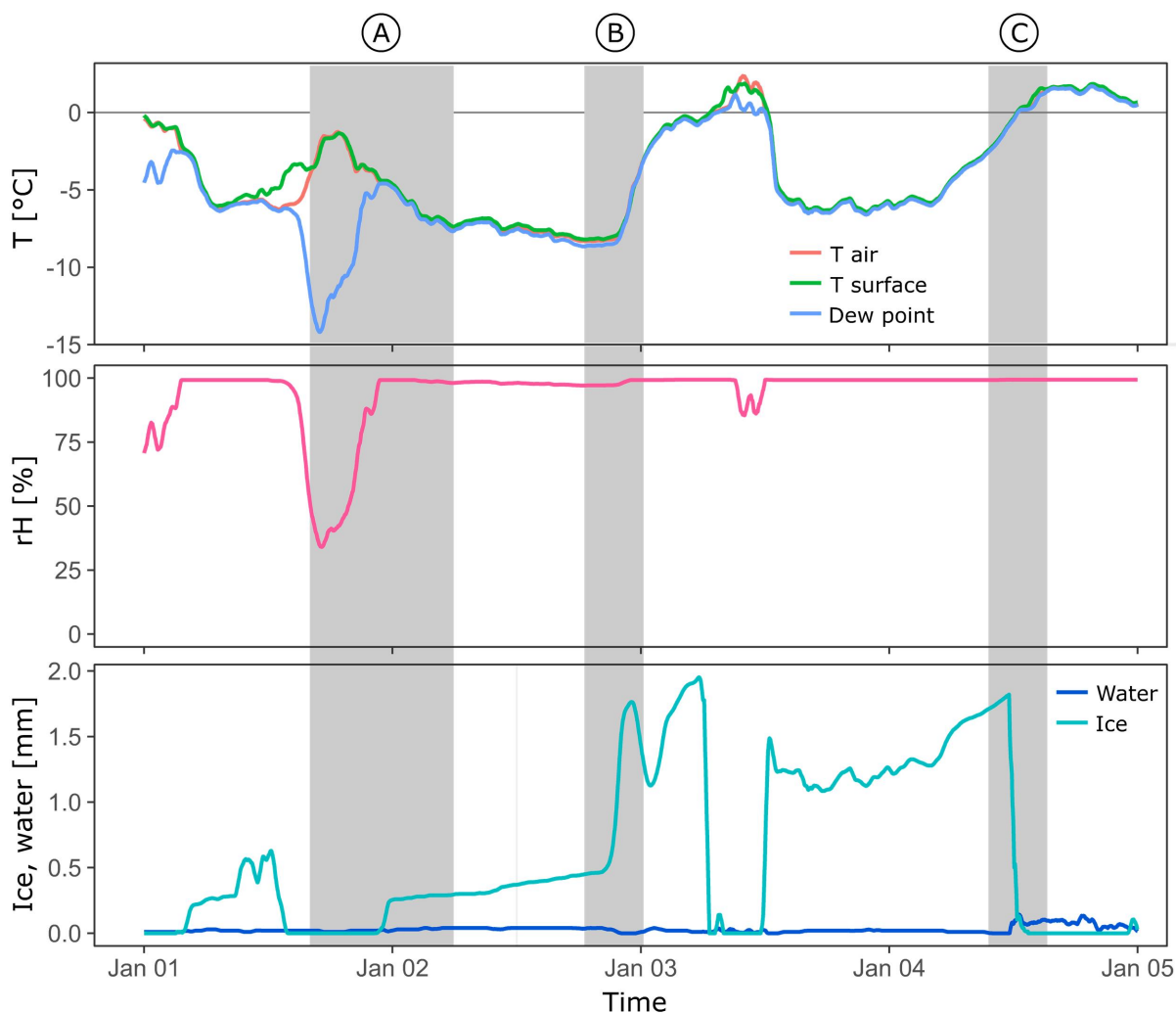

Figure 5 Icing of a Cube 5 sensor

In Figure 5 several icing events of a Cube 5 sensor are illustrated. During period A air and sensor surface temperature are below zero. However, due to relatively dry air no ice is formed on the sensor. Later on, as the temperature drops again, the humidity approaches saturation. As soon as the frost point is reached, ice starts to accrete on the sensor surface and keeps doing so with further falling temperatures.

During period B the temperature reaches a minimum and then rises within a few hours by more than 5°C. Consequently, the ice layer on the sensor grows considerably faster.

In period C the temperature rises from below zero to positive temperatures, keeping its water saturation. Once the temperature passes 0°C the ice on the sensor melts rapidly, which is marked by a sharp drop in ice layer thickness and a slight increase of water on the surface.

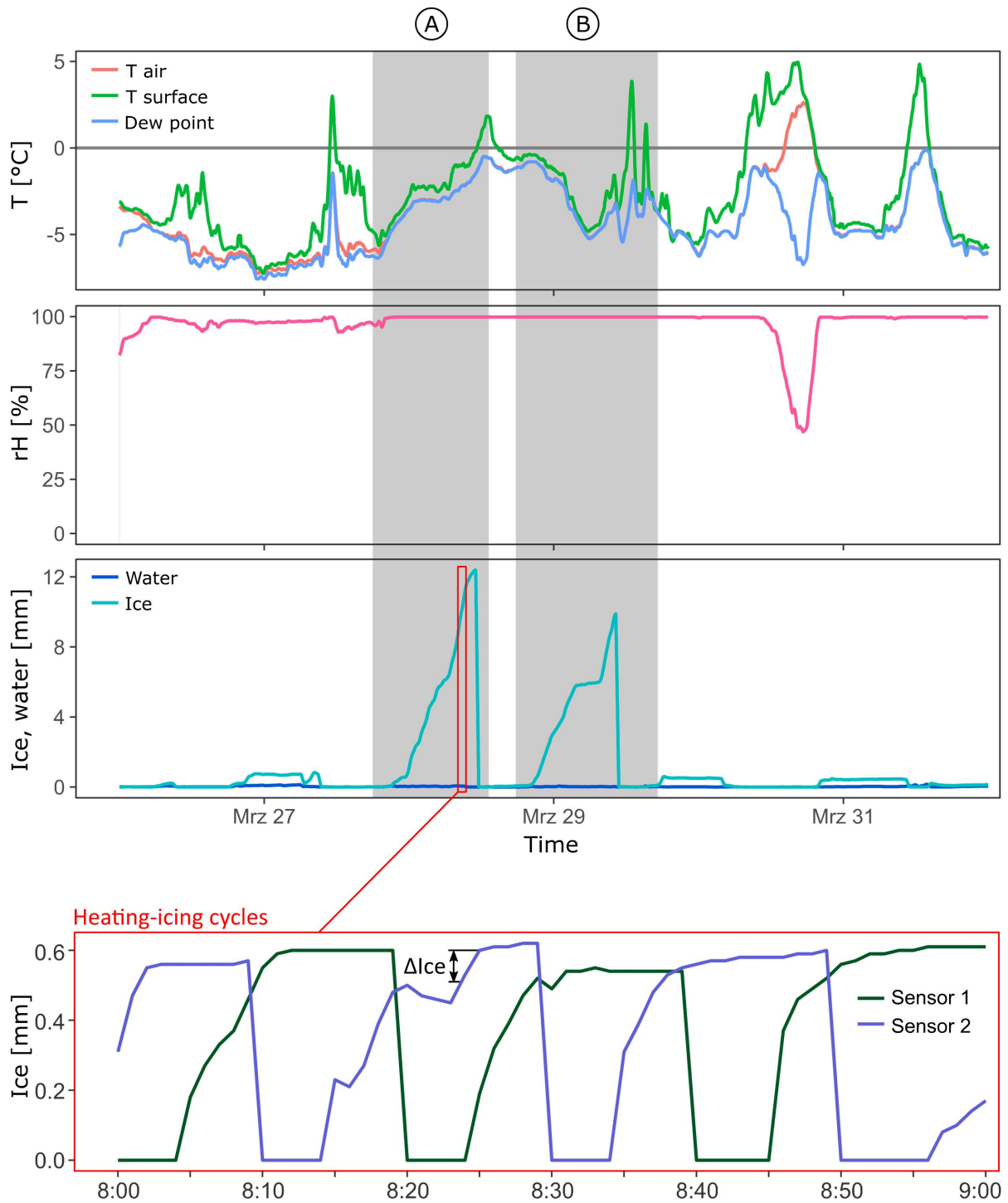

Figure 6 Icing-heating cycle of a Cube 1 sensor pair

In Figure 6 two pronounced icing events are shown. The ice layer on the sensor surface grows at different rates, depending on the ambient temperature. As soon as the sensor surface temperatures rise above 0°C again the ice on the Cube 1 sensors melts rapidly and thus terminates the icing events.

The close-up of [Figure 6](#) also shows the intermittent heating-icing cycles of the two Cube 1 sensors used in the IDS-20a. Whenever one sensor is heated and dried, the other monitors ice accretion. The ice accumulation between two measurements, Δ Ice, is summed up and recorded as the total ice thickness as shown in the Ice graph above.



5 Components

5.1 MAIN connector

| MAIN (12 Pins) | Pin/Wire | Function | Description |
|-------------------------|----------|---------------------|--|
| Power supply | 1 | Vsupply | 10...30 V |
| | 12 | GND | yellow-green |
| RS-485 interface | 2 | RS485 A | 1 x RS-485 (1200...115200 Baud) ASCII – Protokoll Modbus |
| | 3 | RS485 B | |
| SDI-12 interface | 4 | SDI12 | 1 x SDI-12 (1200 Baud) |
| Test-INPUT (Simulation) | 5 | Test | Low Level: 0...0,6 V High Level: 2...30 V |
| Heating | 6 | +24V _{ext} | AC or DC |
| | 7 | -24V _{ext} | AC or DC |
| Relay OUTPUT | 8 | OUT COM | potential-free, max. 0.8A |
| | 9 | OUT Relay B | |
| | 10 | OUT Relay A | |
| | 11 | OUT function | |



ATTENTION The relay outputs are referenced to GND on pin 12.



6 Specifications

| IDS-sensors | | | |
|-------------------------------|---------------|---------------|---------------|
| Sensor type | Cube sensor 5 | Cube sensor 1 | Rod sensor 80 |
| Measuring range ice thickness | 0.1...5 mm | 0.01...1 mm | 1...80 mm |
| Weight | 0.7 kg | 0.7 kg | 2.3 kg |
| Length | 560 mm | 560 mm | 580 mm |

| T/rH-sensor | |
|-----------------|-----------------|
| Dew point | -20...+20 °C |
| Frost point | -20...+20 °C |
| Air temperature | -40...+60 °C |
| Air humidity | 0...100 % |
| Weight | 0.715 kg |
| Size L x W x H | 310 x 120 x 165 |

| IDS-controller | |
|-----------------------|---|
| Power supply | Sensors 10...28 VDC Heating 24 VAC/DC integrated overvoltage protection |
| Power consumption | Active measurement 50 mA at 12 VDC Heating max. 7A at 24 VAC/DC |
| Output | RS-485 (Modbus) SDI-12 3x relay output, max. 0.8 A each |
| Operating temperature | -40...60 °C |
| Protection rating | IP 66 |
| Lightning protection | Integrated Lightning Protection against indirect Lightning; discharge capacity 0,6 kW Ppp |
| Size L x W x H | 318 x 208 x 132 mm |
| Weight | 3.6 kg |

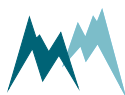

7 Installation

7.1 Site selection

The IDS-20a may be installed as a stand-alone system or mounted to facilities such as wind turbines, utility poles or antennas. To gain icing data that describe the icing on the monitored facility as accurate as possible the IDS-20a has to be installed at a representative position. This means that the ice-sensors should face the same environmental conditions as the monitored facility. Especially, the ice-sensors should not be mounted in the lee of an installation. It is also very important that the ice-sensors are influenced as little as possible by any installation or structure. Make sure that the sensors are not installed too close to your monitored facility.

The sensors and controller of the IDS-20a have very low power consumption and can be operated with an autonomous power supply, e.g. solar generator. However, if the IDS-20a is operated with sensor heating (up to 7 A at 24 VAC/DC) your measurement site needs to have access to mains power.

The IDS-20a must not be installed where passers-by could be hit by falling ice. If required, close off the measurement site and/or indicate the risk.

7.2 Things to consider for installation

7.2.1 Power supply

The IDS-20a consumes 50 mA @ 12 V during active measurements. Between measurements the IDS-20a automatically switches into standby-mode.

The Cube 5 sensor of the IDS-20a is heated if a defined ice-layer thickness is exceeded. This heating requires up to 7A @ 24V and can be provided by either a 24 VAC or 24 VDC power supply. The Rod T 80 sensor has no heating.

7.2.2 Signal cables

Maximum cable length

Please consider the maximum cable lengths for the applied transmission protocol:

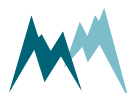

| Protocol | Max. cable length |
|----------|---|
| SDI-12 | ~60 m (depending on wire cross section and number of sensors) |
| RS-485 | ~300 m |

Table 1 Maximum cable lengths



NOTE Cable lengths longer than 60 m require a heavier gauge wire if the power supply drops below 11 V.

7.2.3 Lightning protection

If the underground at the measurement site permits sufficient current dissipation it is strongly recommended to equip the sensor support or mast with properly dimensioned lightning protection. Consult an expert for advice.

The IDS-20a is protected against overvoltage. If a data logger is mounted to the mast, its ground lug must be properly connected to earth ground.

7.3 Required tools and equipment

Prepare the following tools and equipment to install the IDS-20a:

| Qty | Tool |
|-----|--------------------|
| 1 | Flat spanner 13 mm |
| 1 | Wire cutter |

7.4 Mounting

The IDS-20a is shipped with mounting accessories which combine the ice-sensors, T/rH-sensor and the controller to a single unit. Please follow the instructions below to mount your IDS-20a:

1. Mount the IDS-20a controller to the structure of your measurement site with the provided shackles. The housing of the IDS-20a controller provides brackets to mount a horizontal or vertical tube with a diameter up to 60 mm. Tighten the shackles around the tube and secure them with additional nuts.
2. Attach the supplied \varnothing 34 mm mounting tube to the IDS-20a controller as illustrated below. Tighten the shackles around the tube and secure them with additional nuts.

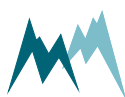

3. Mount the two Cube 1 sensors on the 34-mm tube with the black dot on the sensor heads facing north. Make sure that the sensors are mounted upright. Tighten the shackles around the tube and sensor shaft and secure them with additional nuts. If the sensors are not adjusted towards north, any offset can be corrected for in the Commander software.
4. Insert the T/rH-sensor into the radiation shield and secure it by tightening the plastic nut.
5. Attach the radiation shield in an upright position to the 34-mm tube. Tighten the shackles around the tube and secure them with additional nuts.
6. Connect the sensor cables to the quick-connectors of the IDS-20a controller:
 1. Cube 1 sensors to Sensor 1 and Sensor 2
 2. T/rH-sensor to Temp. rel. H
7. Connect the MAIN sensor cable to the IDS-20a controller.
8. For the sensor heating and controller operation connect your power supply to the other end of the MAIN sensor cable as shown in [Figure 8](#). Separate power supplies for controller and heating may be used. Make sure the power supply for the sensor heating provides sufficient power for defrosting ($\leq 7A$).
9. Connect your data acquisition device to the IDS-20a.
10. Optional: Connect the IDS-20a controller to the switch cabinet provided as an accessory by Sommer Messtechnik.



TIP Sommer provides a switch cabinet for the IDS-20a. This cabinet contains a power supply for sensor heating and controller operation, a data logger as well as a cellular modem for data transmission.

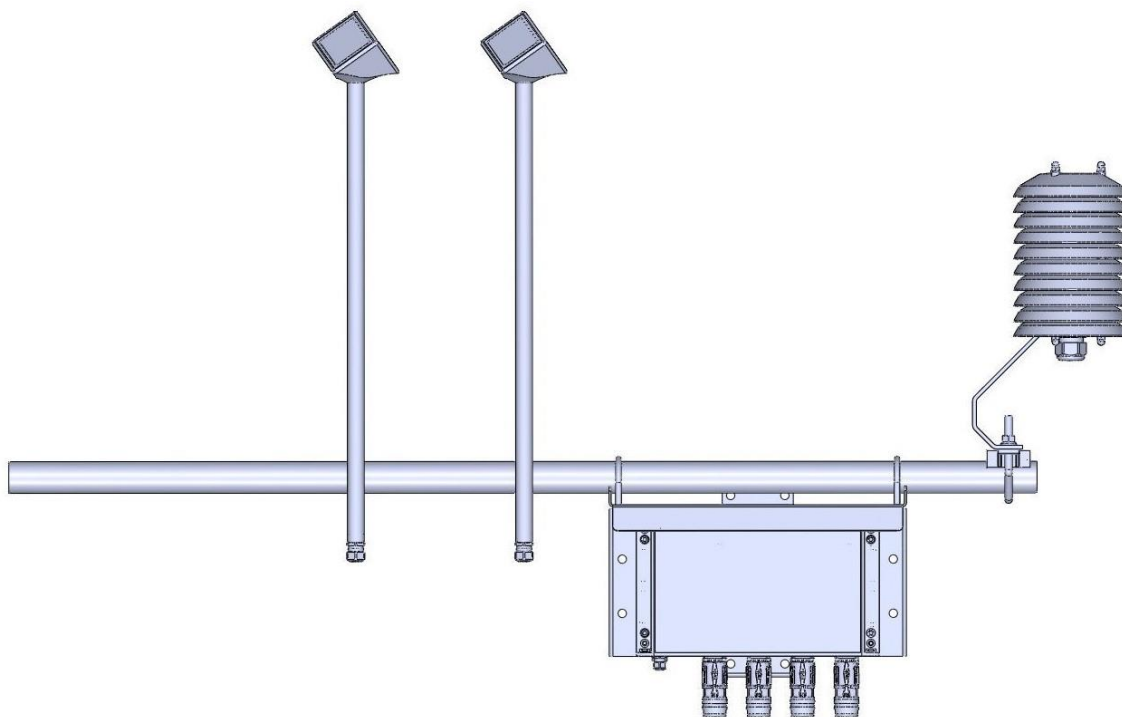

7.5 Wiring

7.5.1 RS-485 wiring

Connect the IDS-20a to a data logger or RS-485 network according to the figure below.

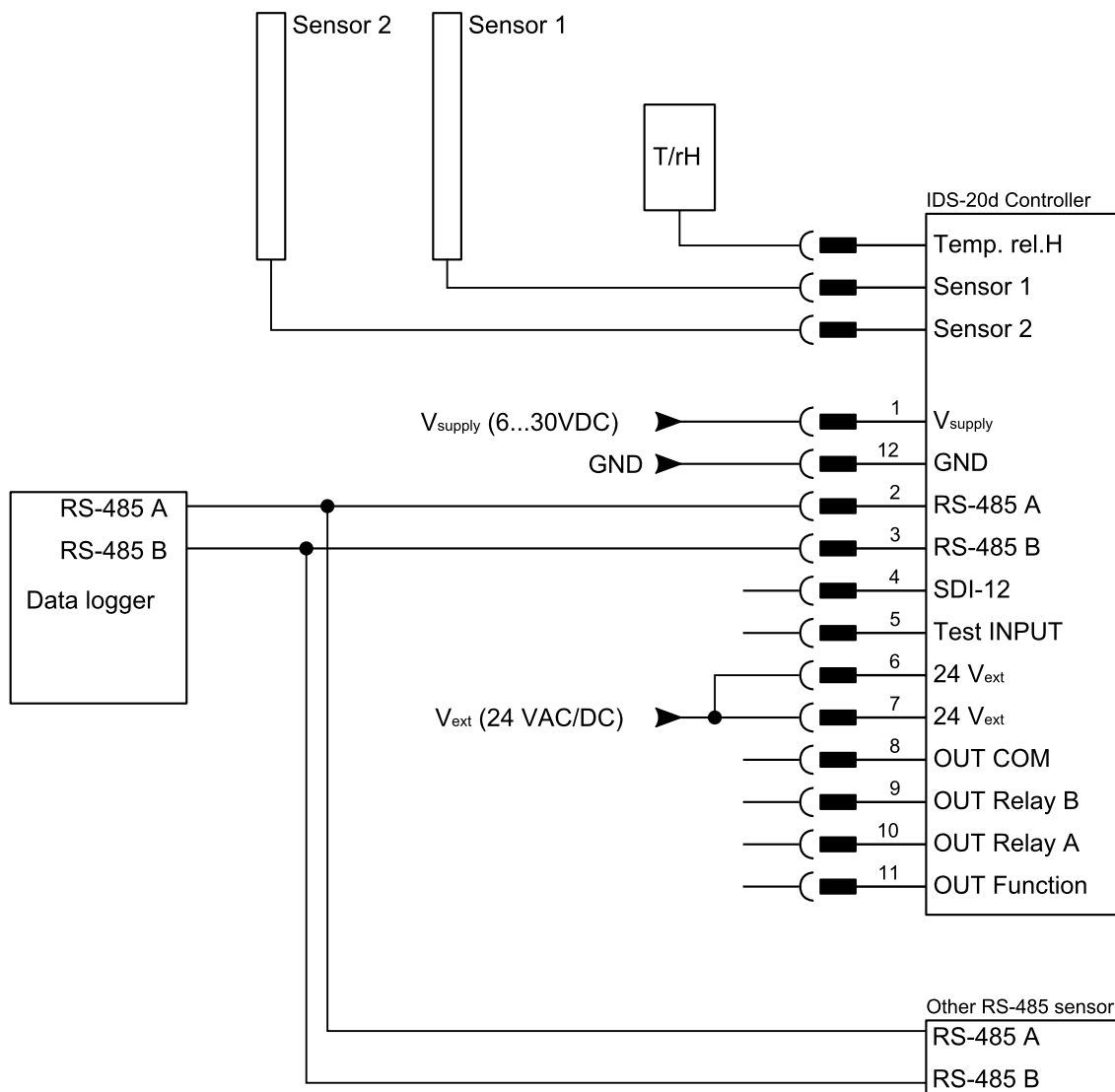

7.5.2 SDI-12 wiring

Connect the IDS-20a to a data logger by SDI-12 according to the figure below.

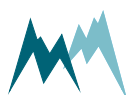

SDI-12 uses a shared bus with a ground wire, a data wire (indicated as SDI-12) and an optional +12 V wire.



NOTE The connection with the 12 V power supply is optional and depends on the connected SDI-12 master device (typically a data logger).

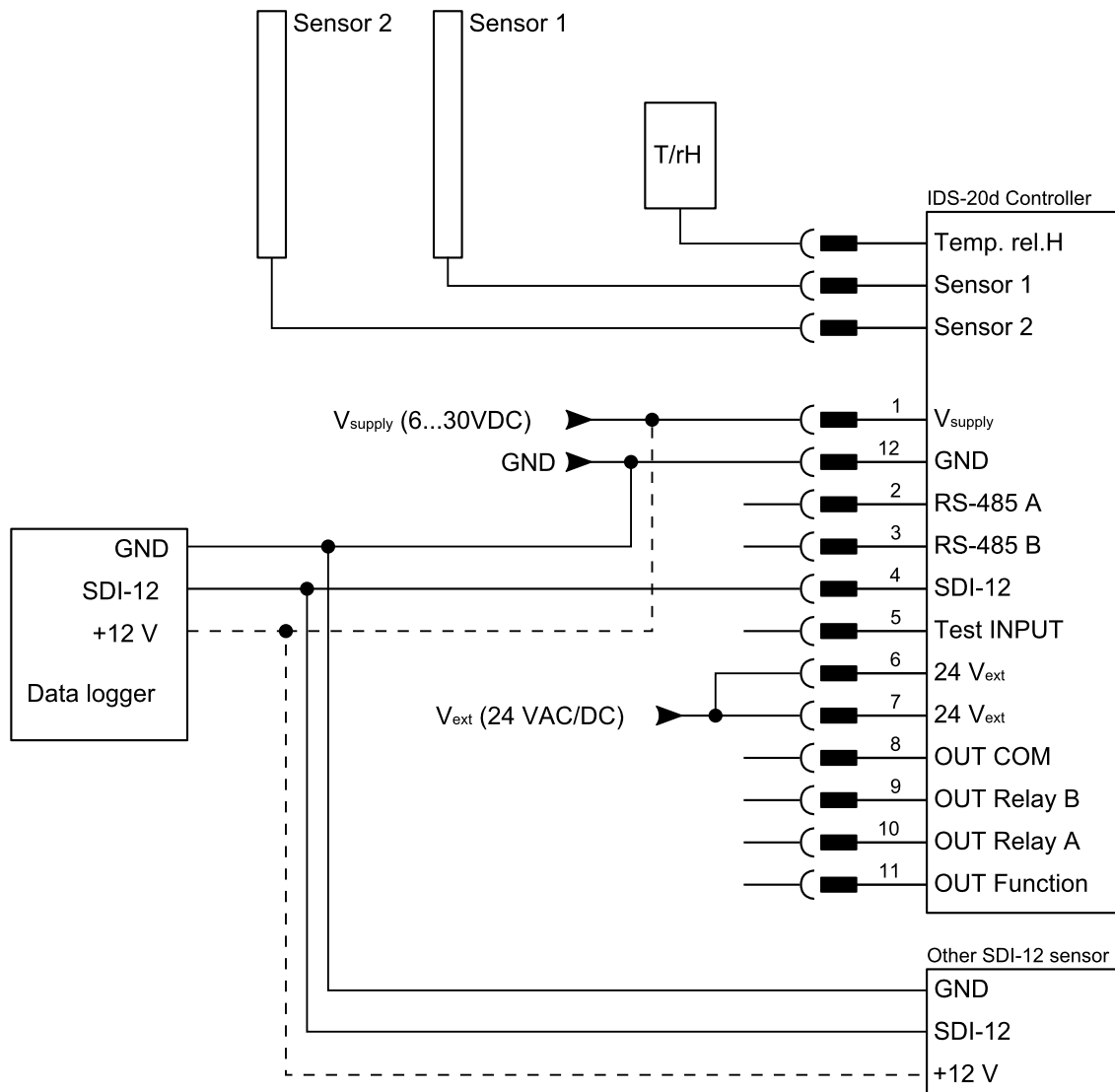
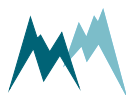

Figure 7 Wiring of the IDS-20a with a data logger via SDI-12

7.6 Start-up

After successful testing, verify that the measurement data are recorded by your data acquisition system and check the data transmission to the remote server if applicable.



8 Operation

8.1 Connect device to PC

1. Install the Commander support software (see [Installation of Commander](#)).
2. Connect the yellow and gray wires of the sensor cable to the RS-485 to USB converter cable and plug it into your PC as illustrated in the figure below.
3. Connect a 9...28 VDC power supply to the IDS-20a as shown in the figure below.
4. Click on [Communication assistant](#) on the right-hand side of the Commander window and follow the instructions.
 - a. As [Type of connection](#) select *Serial connection*
 - b. As [Device type](#) select *Sensor (9600 Bd)*
 - c. Select [New connection](#) and select the COM port

During this procedure the communication assistant will search for connected devices. Upon successful completion, the new connection is added to the connections list (tab [Connections \(F8\)](#)).

5. In the [Communication](#) section at the right-hand side of the Commander window select [Mode Connection](#) and the previously created connection from the drop-down list.
6. Click [Connect](#) to establish a connection with the IDS-20a. If the connection was successful a green icon is displayed at the top-right corner of the Commander window.
7. Select the tab [Parameters \(F2\)](#) and click [Download parameters from device](#) on the left side of the Commander window. The complete parameter list is transferred from the sensor to your PC and displayed in the [Parameter](#) window.

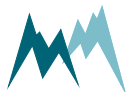

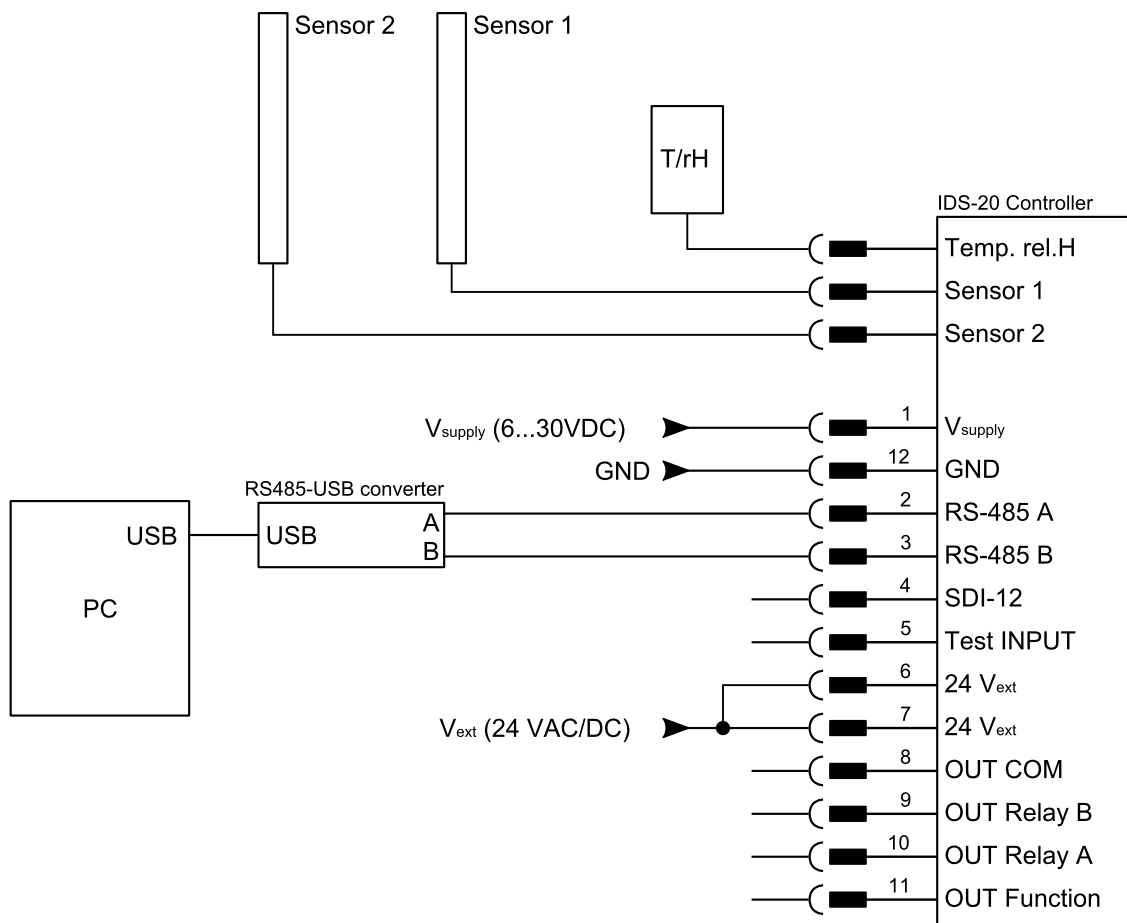

To activate the communication between your device and the Commander software follow the steps described in [Working with connections](#).

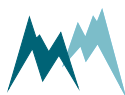

9 Maintenance

The IDS-20a generally does not require any special maintenance. However, the ice-monitoring system should be inspected regularly for any damage or soiling on the Cube 5 sensor and any dirt on the tip of the T/rH-sensor. If required, the sensor head and rods can be cleaned with water.

It is recommended to compare the temperature measurements of the ice-sensors and the T/rH-sensor regularly. Any offset can be corrected in the IDS-20a setup section [Technics](#). If the temperature offset should be too large, a sensor recalibration is recommended.

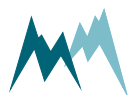

10 Support software Commander

10.1 Software features

The Commander is a multipurpose software tool to configure and operate any Sommer Messtechnik device. It offers the following functions:

- Communication with Sommer Messtechnik sensors and data loggers via serial connection, modem, socket, IP-call and Bluetooth®
- Management of connections and stations
- Configurations of sensors and data loggers
- Live data monitoring and storage
- Data management including download from data loggers and transmission to MDS (Measurement Data server)
- Terminal window to check data transfer and to access device settings directly

10.2 System requirements

The Commander software supports 32- and 64-bit versions of Windows 7 SP1, Windows 8, Windows 8.1, Windows 10 and Windows 11.

For correct operation Microsoft® .NET Framework 4.5 or later must be installed.

10.3 Installation of Commander

Follow the steps below to install the Commander software:

1. Plug the USB stick shipped with the device into your PC.
2. Double-click the `commander.msi` installer file on the USB drive.
3. Click **Next** on the pop-up window

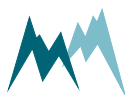



4. Read the instructions and click [Next](#)

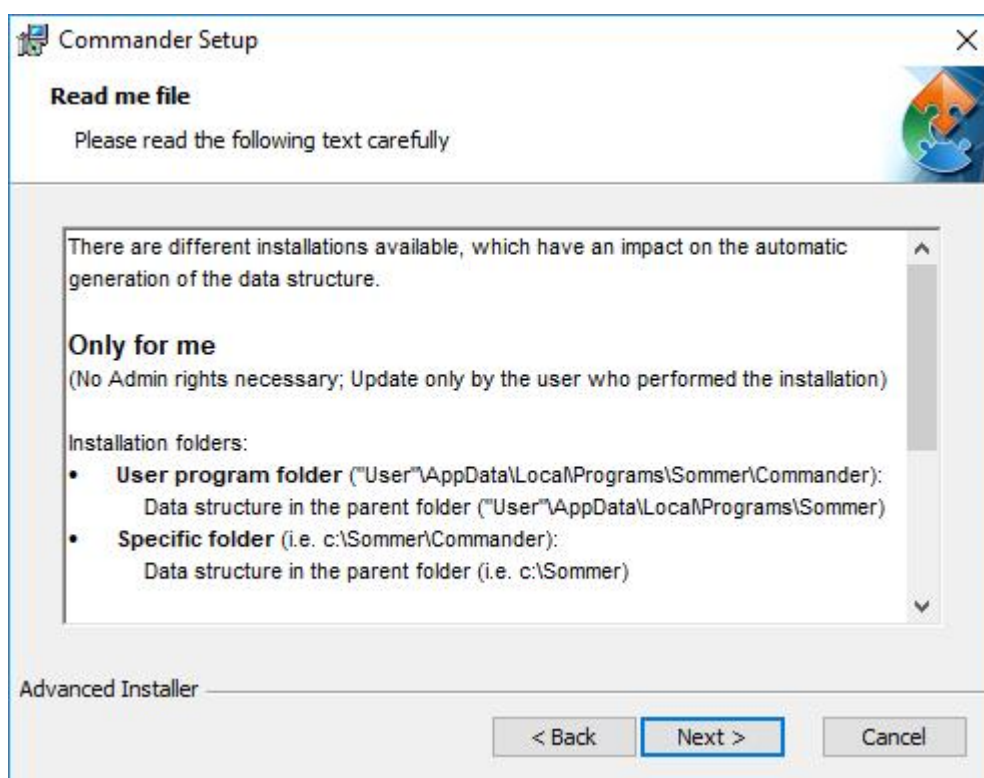

5. Select the installation type and click [Next](#)

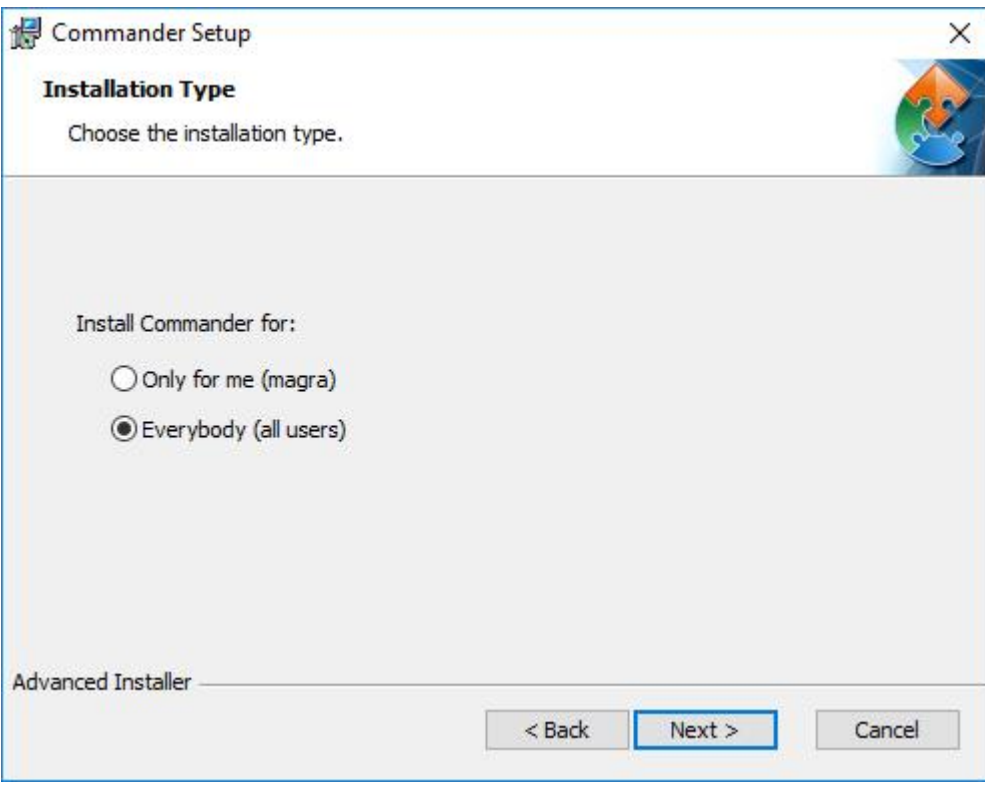

NOTE

Two installation types are available. Depending on the selection, the access rights and the folder structure differ:

Only for me

No admin rights are required. Updates are only available to the user who installed the software.

Installation folders:

- User program folder:
Users\User\AppData\Local\Programs\Sommer\Commander

Data structure:

Users\User\AppData\Local\Programs\Sommer

- Specific folder (default):

C:\Sommer\Commander

Data structure (default):

C:\Sommer

Everybody

Admin rights are required. Updates may only be performed by system administrators.

Installation folders:

- Standard program folder:
Program Files (x86)\Sommer\Commander

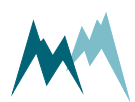

 Data structure:
 Users\Public\Public documents\Sommer

- Specific folder (default):
 C:\Sommer\Commander

Data structure (default):
 C:\Sommer

6. Select the installation directory and click **Next**.

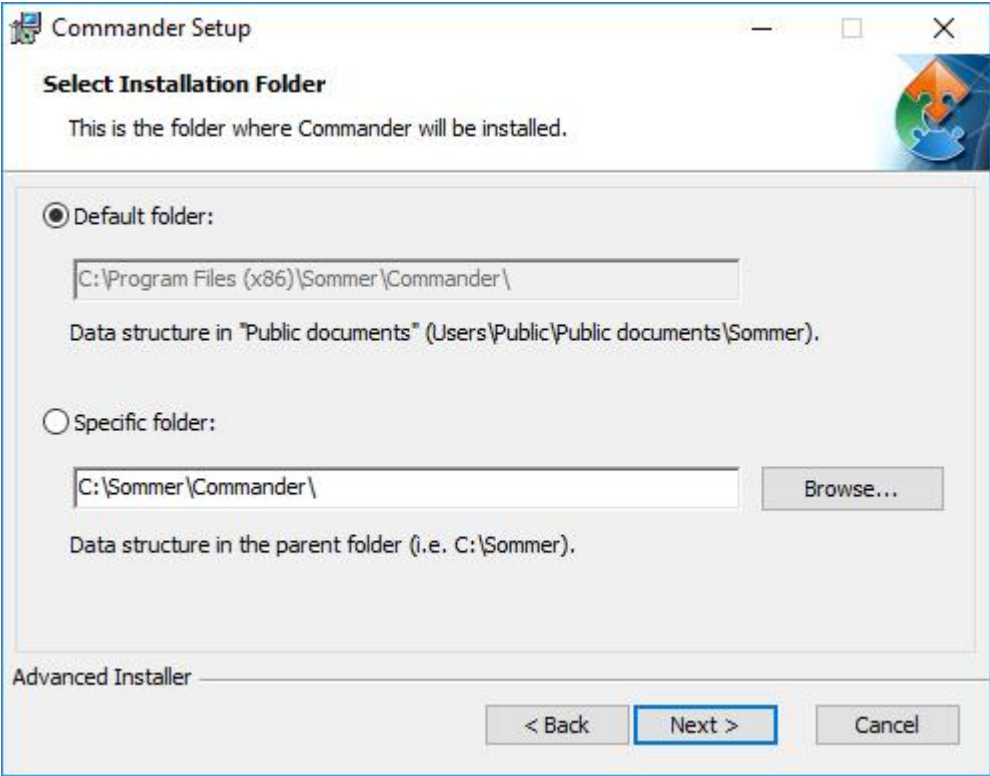

7. Select the features to be installed and click **Next**.

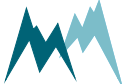

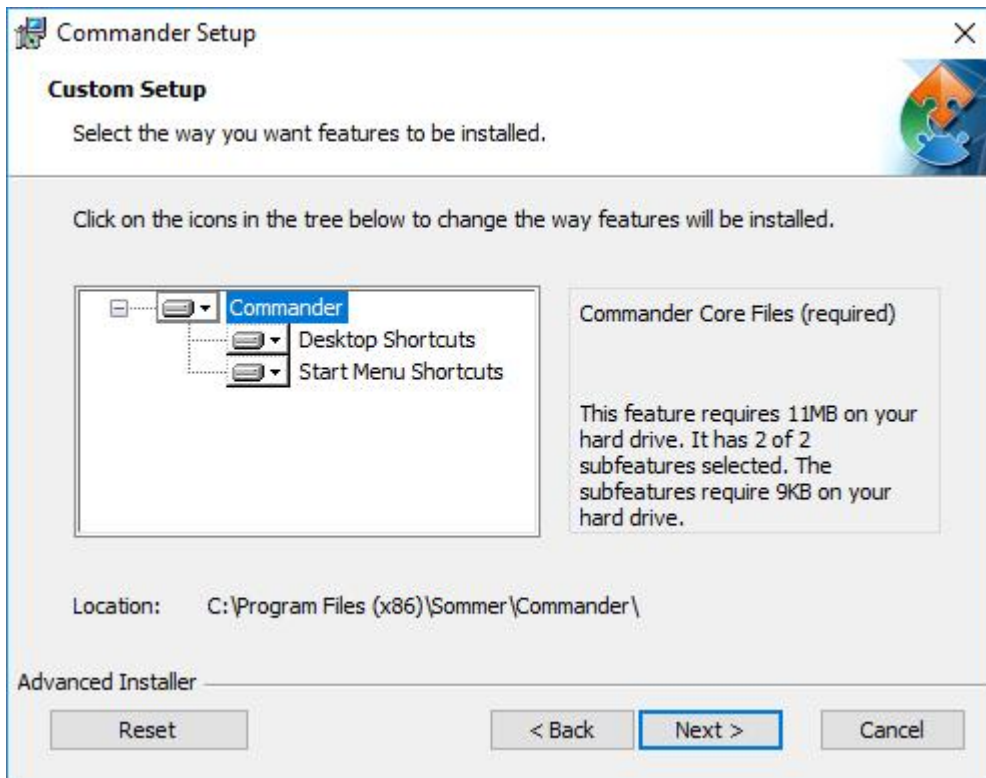

8. Click **Install** to start the installation.

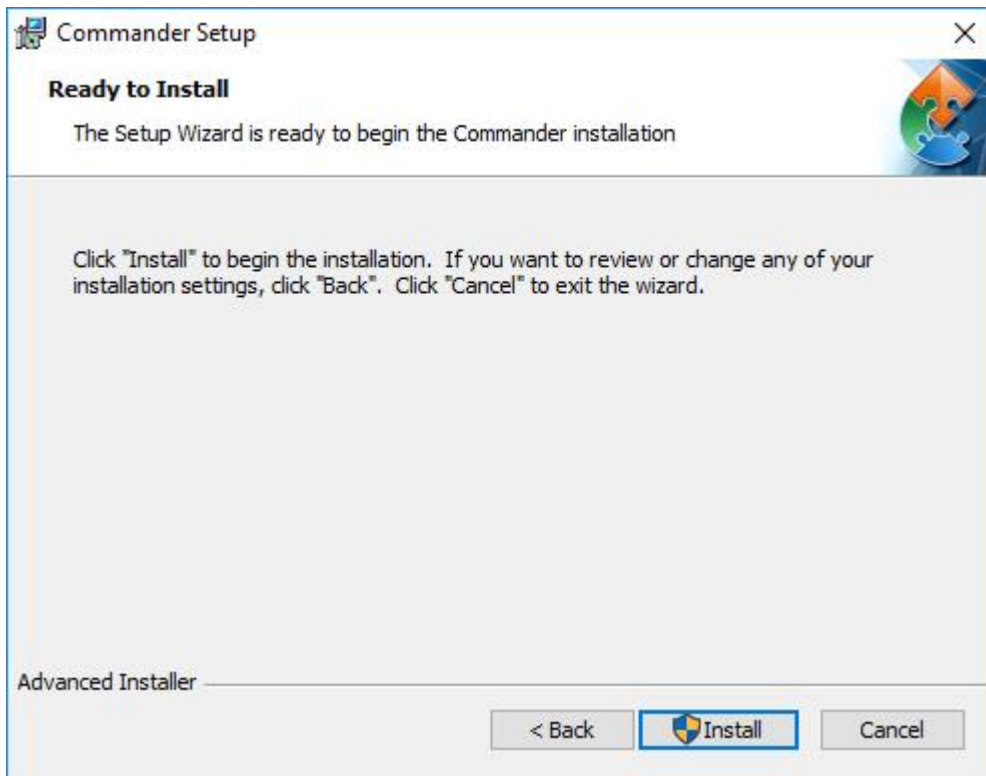

9. Click **Finish** to complete the installation.

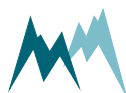

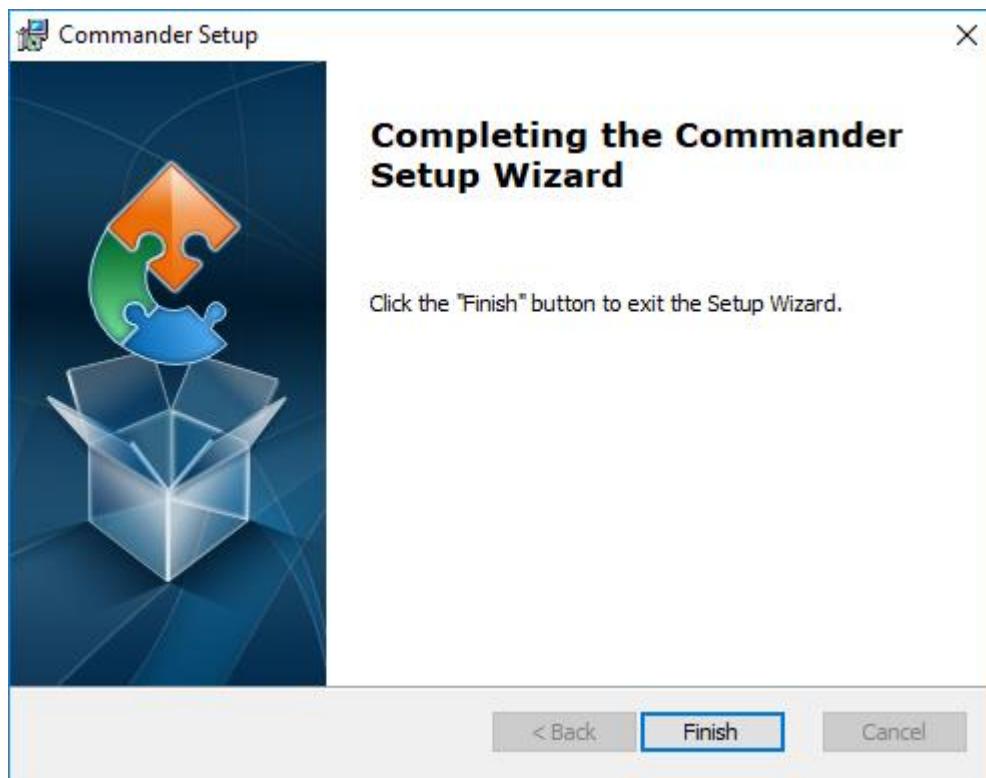

10.4 Change authorization

To prevent unintended changes of parameters in the **Technics** menu authorization is generally set to **Normal**. Parameter modifications in **Technics** are enabled by switching the authorization level to **Expert** as described below:

1. On the upper tab bar click on **Options** and select **Common**.
2. In the Options window select authorization **Expert** and click **OK**.

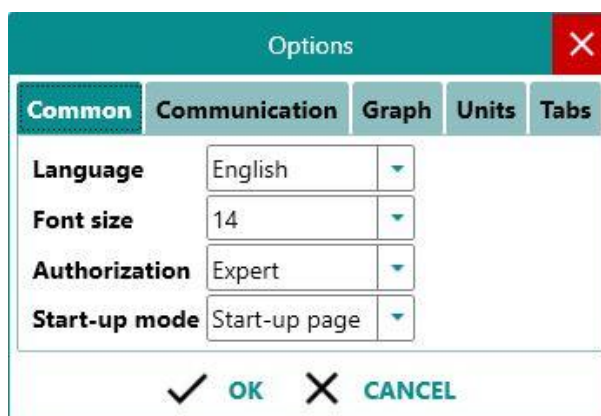

10.5 Working with connections

10.5.1 Establish a connection with the Communication assistant

1. Install the Commander support software as described in [Installation of Commander](#).
2. Connect the device to your PC.
3. Start the Commander software on your PC.
4. Click on [Communication assistant](#) on the right-hand side of the Commander window and follow the instructions. During this procedure the communication assistant will search for connected devices. Upon successful completion, the new connection is added to the connections list (tab [Connections \(F8\)](#)).
5. In the [Communication](#) section at the right-hand side of the Commander window select Mode [Connection](#) and the previously created connection from the drop-down list.
6. Click [Connect](#) to establish a connection with the IDS-20a. If the connection was successful a green icon is displayed at the top-right corner of the Commander window.

To view the settings of the connected device or to read the current measurements, follow the steps described in [Download setup](#) and [Record measurements](#).

10.5.2 Establish a connection manually

1. Install the Commander support software as described in [Installation of Commander](#).
2. Connect the device to your PC.
3. Start the Commander software on your PC.
4. Select the required connection in the [Connections](#) list of the [Connections \(F8\)](#) tab and click [Connect](#). If the connection was successful a green icon is displayed at the top-right corner of the Commander window.
If you don't have the required connection available in the [Connections](#) list, create a new connection as described in [Create a new connection](#).

To view the settings of the connected device or to read the current measurements, follow the steps described in [Download setup](#) and [Record measurements](#).

10.5.3 Create a new connection

1. Select the [Connections \(F8\)](#) tab in the Commander.
2. Click [New connection](#).
3. In the section [Connection settings](#) enter a name of the new connection, e.g. *Serial-com1-9600*, and the connection type, e.g. *Serial connection*.



4. Enter the required information for the selected connection type.
If your IDS-20a is wired to your PC with a RS-485 to USB converter cable, select the port where the device is connected and select a Baud rate of 9800.

10.6 Working with stations

10.6.1 Create a station with the Communication assistant

In order to manage several data loggers, to connect to a data logger via IP-call and to download data, stations can be created in the Commander software. To view a list of all stations select the tab [Stations \(F7\)](#).

Perform the following steps to create a new station with the [Communication assistant](#):

1. Click on [Communication assistant](#) in the Commander-window

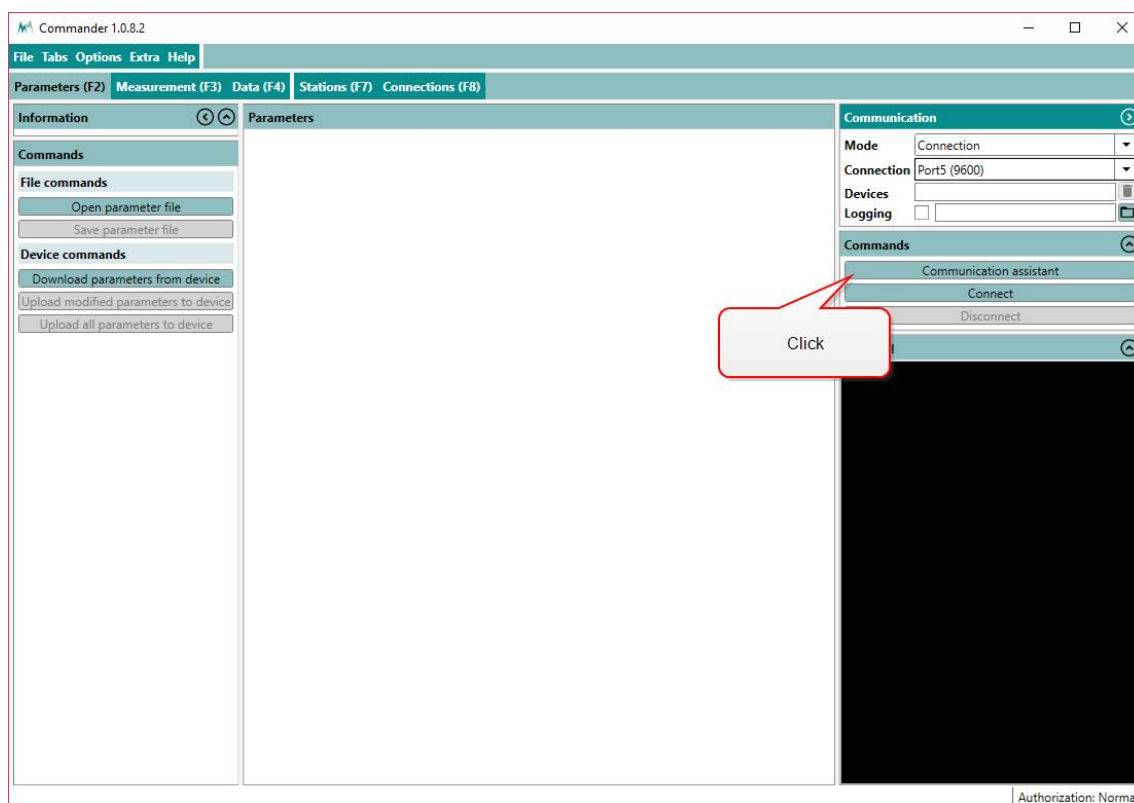

2. In the pop-up window choose the required connection and click [Next](#).

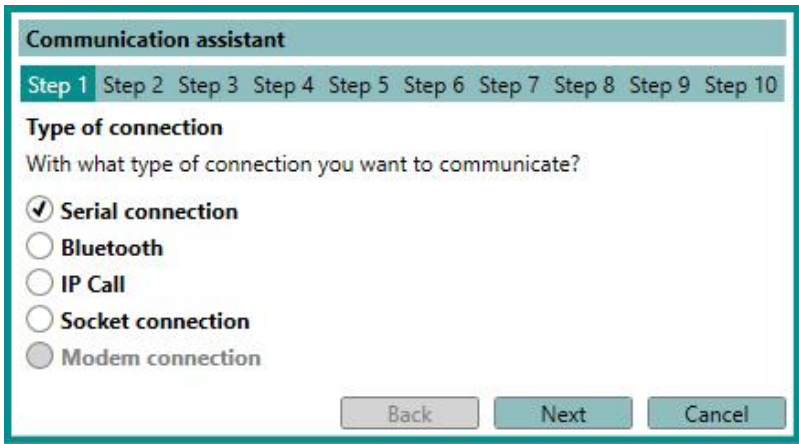

3. Verify that the IDS-20a is connected to your PC and a power supply. Click **Next**.



4. Select **Logger (115200 Bd)** and click **Next**.

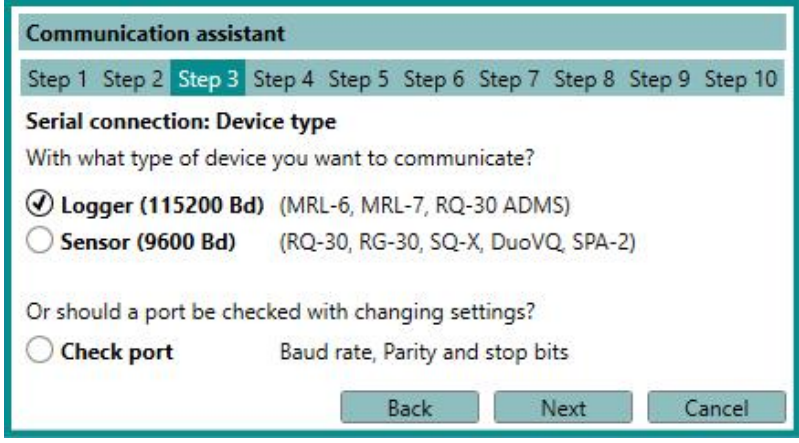

5. Select **Scan ports** and click **Next**.



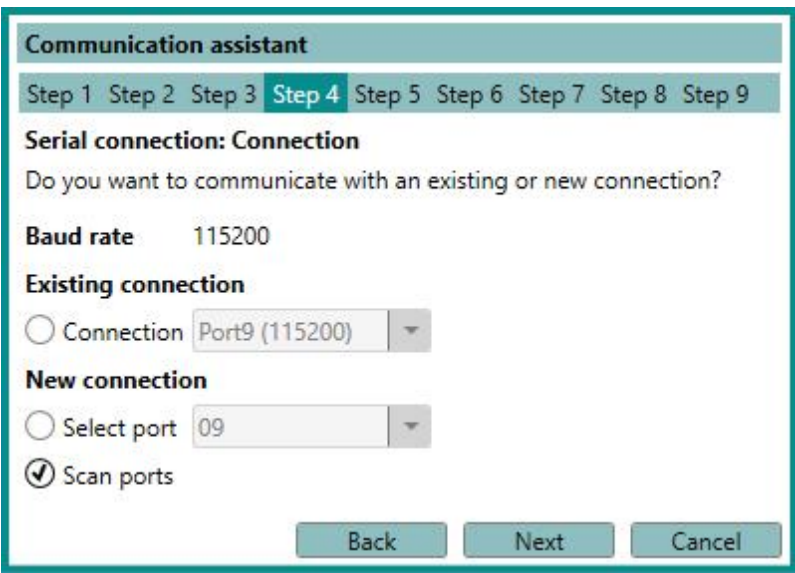

6. The Commander now scans all available ports.

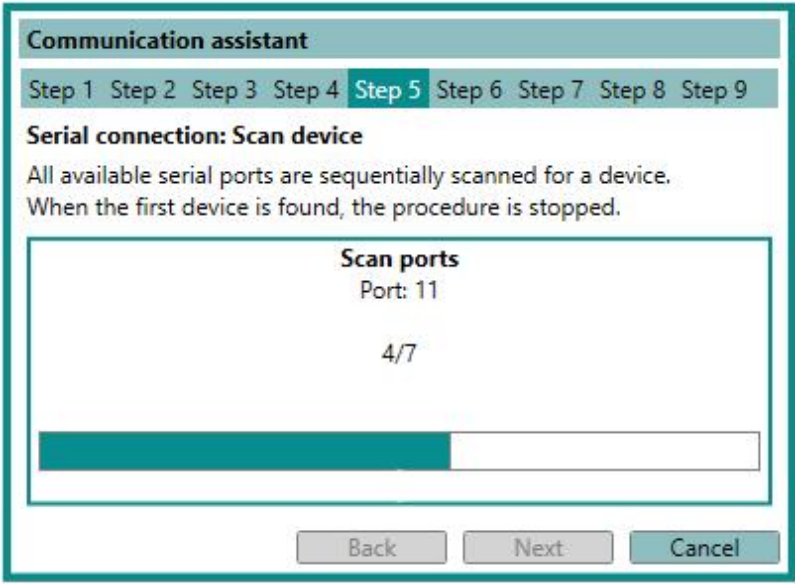

7. Adopt the *Name* provided by the communication assistant. Click *Next*.

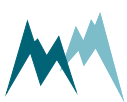

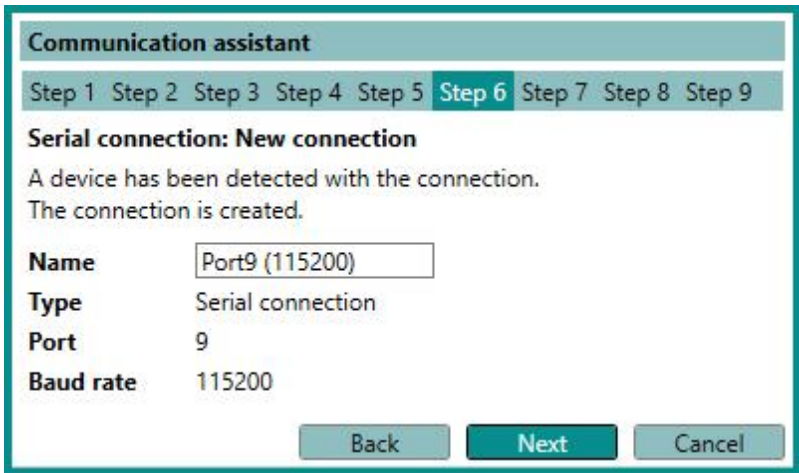

8. The Commander now scans the selected port for connected devices.

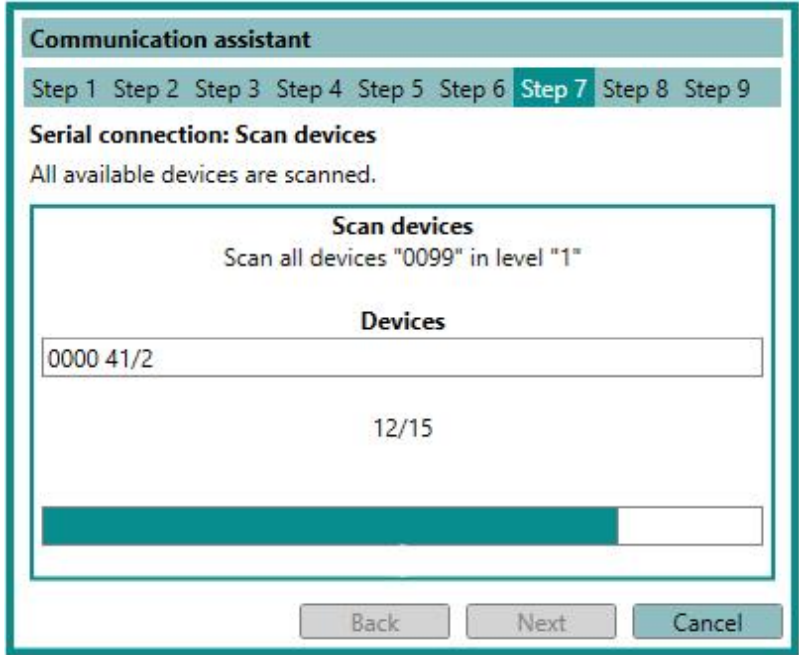

9. Adopt the *Name* of the new station or enter a new name. Click *Next*.

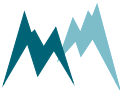

Communication assistant

Step 1 Step 2 Step 3 Step 4 Step 5 Step 6 Step 7 **Step 8** Step 9

New station

No matching station has been found.
Changes of the station number are performed on the device as well.

Station ID 05170012

Station number

Name

Devices

Do you want to save the station?

10. A new station has now been created. Click [Finish](#).

Communication assistant

Step 1 Step 2 Step 3 Step 4 Step 5 Step 6 Step 7 Step 8 **Step 9**

Station selected

The station has been selected and can now be used.

11. The newly created station can now be selected in the [Communication](#) section of the Commander. Click [Connect](#) to activate the connection to your device.

10.6.2 Create a station manually

In order to manage several data loggers, to connect to a data logger via IP-call and to download data, stations can be created in the Commander software. To view a list of all stations select the tab [Stations \(F7\)](#).

Perform the following steps to create a new station:

1. In the tab-menu [Stations \(F7\)](#) click [New station](#).
2. Under [Station settings](#) enter the [Station number](#) and [Sommer ID](#). By default both settings are set to the device's serial number (visible on the IDS-20a housing).
3. Select the [Connections](#) used for the station. Multiple selections are possible; the default connection can be selected by ticking the circular field.
4. Depending on the connection type, enter the additional information, e.g. [Address](#) for a Bluetooth connection or [IMSI number](#) for an IP call.

5. Enter the settings for **Data** management. When data are downloaded from a connected IDS-20a they are stored in an archive-file by default. Each archive-file contains the data of a year or month, as selected in **Archive type**. Selection **None** will save all data in one file. The default location for data files is C:\Users\Public\Documents\Sommer\Data\.
6. Save the newly created station with the button **Save station**.

10.7 Working with measurements

10.7.1 Poll continuous measurements

1. Establish a connection to your device as described in [Working with connections](#).
2. Download the setup of your device as described in [Download setup](#).
3. Select the **Measurement (F3)** tab.
4. In the **Commands** section click **Start polling measurement**.
5. Select the option **Polling with measurements**. Now, the Commander will trigger measurements of the IDS-20a without any delays between measurements. The results are displayed **Measurement values** and plotted in the **Measurement data graph**.
6. To finish polling mode click **Stop polling**.

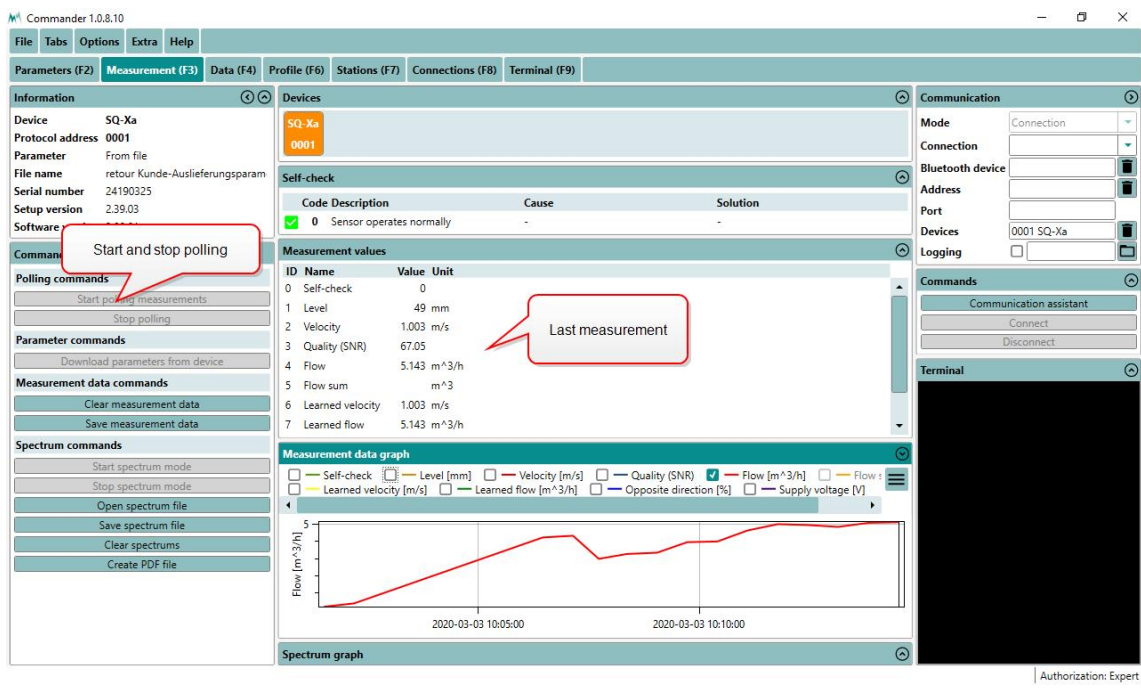

NOTE The polling mode stops automatically after 30 minutes.

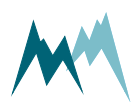

10.7.2 Record measurements

1. Establish a connection to your device as described in [Working with connections](#).
2. Download the setup of your device as described in [Download setup](#).
3. Select the [Measurement \(F3\)](#) tab.
4. Make sure that [Measurement output](#) is set to *Measured values push* or *Storage values push*.
5. If the connection with your device is active, the data will now be displayed in the measurement table and updated at the interval specified in the setup. Also, the incoming data strings are displayed in the [Terminal](#).
6. Click [Save measurement data](#) in the [Commands](#) section to save the recorded measurements. The data are saved as a *.csv file in the SommerXF format.



NOTE You can change the scope of the data output in the setup [Information](#).

10.8 Working with data

10.8.1 View live data

Follow the steps below to view live data acquired from your device:

1. Establish a direct or remote connection with the IDS-20a using the Commander. Use an existing Commander-connection or -station if available.
2. In the [Parameters \(F2\)](#) tab download the parameters of the IDS-20a.
3. Now, there are two options to view the measurement data:
 1. If [Measurement output](#) is set to *Measured values push* or *Storage values push*, data are displayed in the [Measurement \(F3\)](#) tab in the specified measurement interval.
 2. Open the [Measurement \(F3\)](#) tab and click [Start polling measurements](#). With this option measurements are triggered in the fastest possible sequence and the results are displayed instantly. This measurement mode can be stopped by clicking [Stop polling](#), or it is finished automatically after 30 minutes.

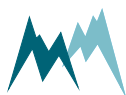

10.9 Working with spectra

10.9.1 Record spectrum

1. Establish a connection to your device as described in [Working with connections](#).
2. Download the setup of your device as described in [Download setup](#).
3. Select the [Measurement \(F3\)](#) tab.
4. Click [Start spectrum mode](#) in the [Commands](#) section. Now the Commander collects the spectrum data and displays them in [Spectrum graph](#).



NOTE The collection of the spectrum data may require some time.

5. Click [Save spectrum file](#) in the [Commands](#) section to save the recorded spectra. The data are saved as a *.xlms file.



NOTE The number of acquired spectra is displayed at the bottom of the [Spectrum graph](#). You can navigate through the spectra by clicking the navigation buttons.

6. Click [Stop spectrum mode](#) to quit recording spectra.

10.9.2 Read spectrum file

1. Open the Commander.
2. Click [Open spectrum file](#) in the [Commands](#) section.
3. Select the desired spectrum file (*.xmls) and click [Open](#). The spectra are now opened and displayed in the [Spectrum graph](#).



NOTE The number of acquired spectra is displayed at the bottom of the [Spectrum graph](#). You can navigate through the spectra by clicking the navigation buttons.

10.10 Working with setups

10.10.1 Download setup

1. Establish a connection to your device as described in [Working with connections](#).
2. Select the [Parameters \(F2\)](#) tab in the Commander software.
3. In the [Commands](#) section click [Download parameters from device](#).

The Commander now downloads the setup currently active on the IDS-20a. This may take some time if you are downloading the setup for the first time to your PC. Consecutive downloads of a setup with the same version number will be faster as the parameter structure is already available.

You can now save the setup file by clicking [Save parameter file](#), or edit the settings as described in [Edit setup](#).



TIP Save the setup on your PC before you make any changes!

10.10.2 Open a setup file

1. Start the Commander on your PC and connect to your IDS-20a either directly with the USB to RS485 isolated converter cable or, if available, the optional Bluetooth connection.
2. Open the [Parameters \(F2\)](#) tab and click [Open parameter file](#). Select the required file (extension .xml or .xmla).
3. Verify the new settings and click [Upload all parameters to device](#). After completion the new settings are active on your data logger.

10.10.3 Edit setup

1. Open the setup file as described in [Open a setup file](#) or download it from your device as described in [Download setup](#).
2. Adapt the values of the settings in question and press Enter after each. After you have changed a value, its text box will turn red.



NOTE If you have entered a value outside the data range of the setting, it will be forced to the next valid value! The valid range of each setting is listed in the [Parameter definitions](#).

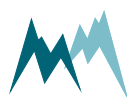

3. After you have adapted all required settings save the setup file and/or upload the setup to your device by clicking [Upload modified parameters to device](#).
Once the setup has been saved or uploaded, the modified red text boxes will turn white again, indicating that the settings have been saved/applied.

10.10.4 Upload new setup file

1. Establish a connection to your device as described in [Working with connections](#).
2. Select the [Parameters \(F2\)](#) tab.
3. Download the setup currently on the IDS-20a as described in [Download setup](#) and save it by clicking [Save parameter file](#). This step is recommended to have the latest setup available for documentation.
4. Click [Open parameter file](#) and select the required setup file (*.xlm) on your PC.
5. Click [Upload all parameters to device](#). This transfers the current setup to the IDS-20a.
6. To verify the correct upload click [Download parameters from device](#). This will display the present setup of the IDS-20a.

10.11 Update firmware

1. Connect the IDS-20a to your PC with the USB to RS485 isolated converter cable.
2. Make sure no connection is active in the Commander (no green icon at the top-right corner).
3. Click on the menu item [Extra](#) and select [Start Programmer](#).
4. Select the firmware file (*.hex) provided by SOMMER Messtechnik. Make sure the file is stored on your PC and not on a USB or network drive.
5. Choose the COM-port the data logger is connected to and a Baud-rate of 57'600.
6. Perform the following three steps in short sequence:
 - Click [Program](#)
 - Unpower the data logger
 - Wait 3...5 seconds to enable full activation of the bootloader and a correct restart (capacitors must be discharged, and if the device had been in sleep mode, this can take some time)
 - Repower the data logger

The firmware currently present on the data logger is now erased and the new one copied to the data logger. During the update process the pop-up window may show the following messages:

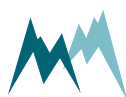

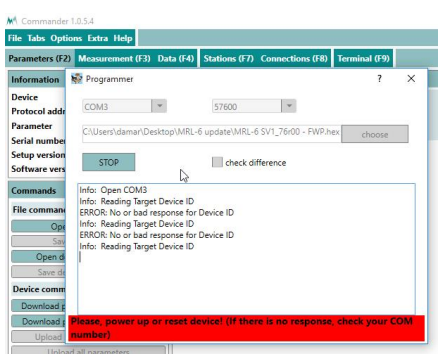

The programmer is not ready; power needs to be on.

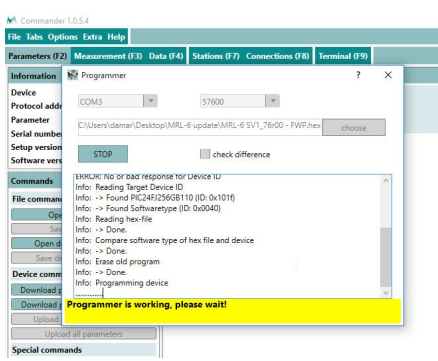

The programmer is active.

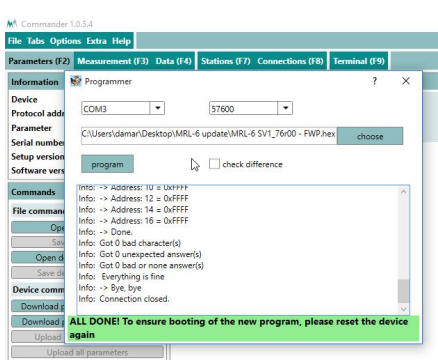

The firmware update has finished.

7. Close the programmer-window as soon as the firmware update has finished.
8. Switch off and repower the data logger again.
9. Open the **Parameters (F2)** tab.
10. Click **Download parameters from device**. The download of the new parameter list might take a few minutes as the parameter structure may need to be downloaded as well. After completion the new firmware and setup versions will be displayed in the **Information** section.

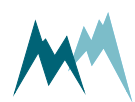

11 Configuration of the IDS-20a

11.1 Software tools

The IDS-20a can be configured with one of the following tools:

- Configuration with Commander support software
- Configuration with a terminal program

11.2 Configuration with Commander support software

Follow the steps below to modify the configuration parameters of the IDS-20a:

1. Establish a connection between your PC and the IDS-20a.
2. Select the tab **Parameters (F2)** and click **Download parameters from device**. The complete parameter list is transferred from the sensor to your PC and displayed in the Parameter window.

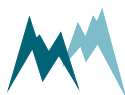
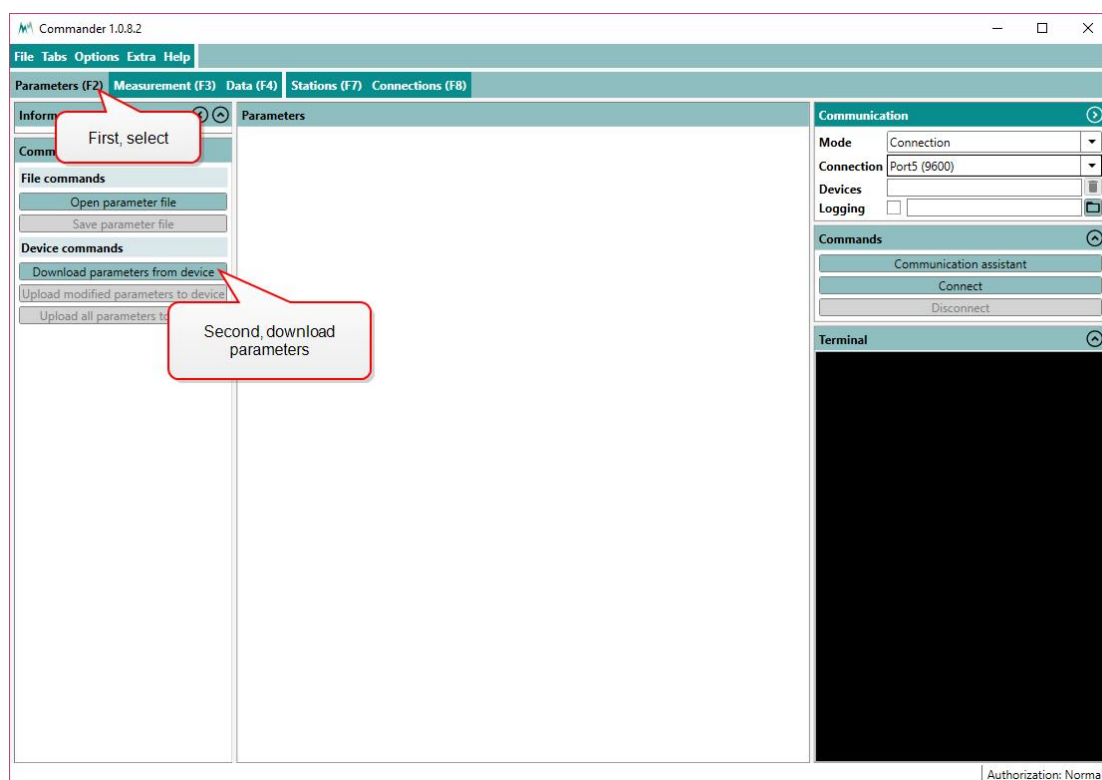



NOTE The first download of the parameter list may take a few minutes. After that the device is known to the PC and consecutive downloads are much faster.

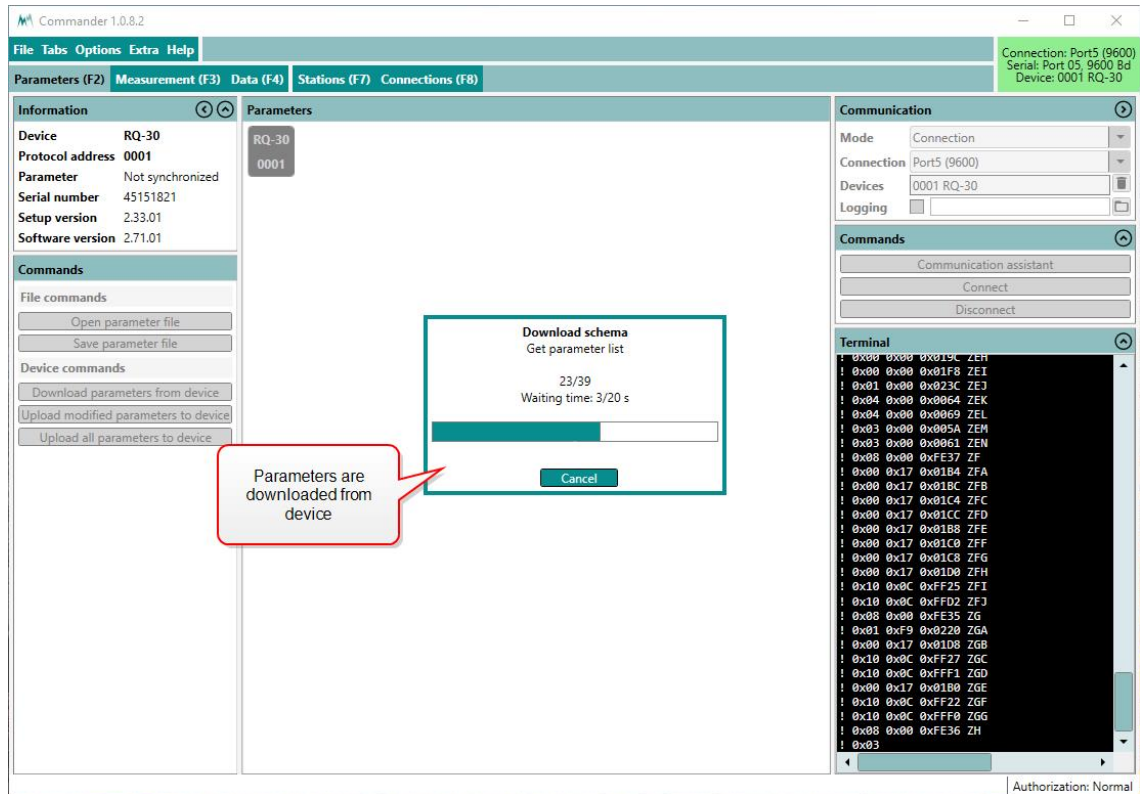

3. Save the parameter file to your PC by clicking **Save parameter file**. This step is recommended to track any configuration changes.

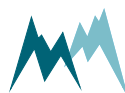

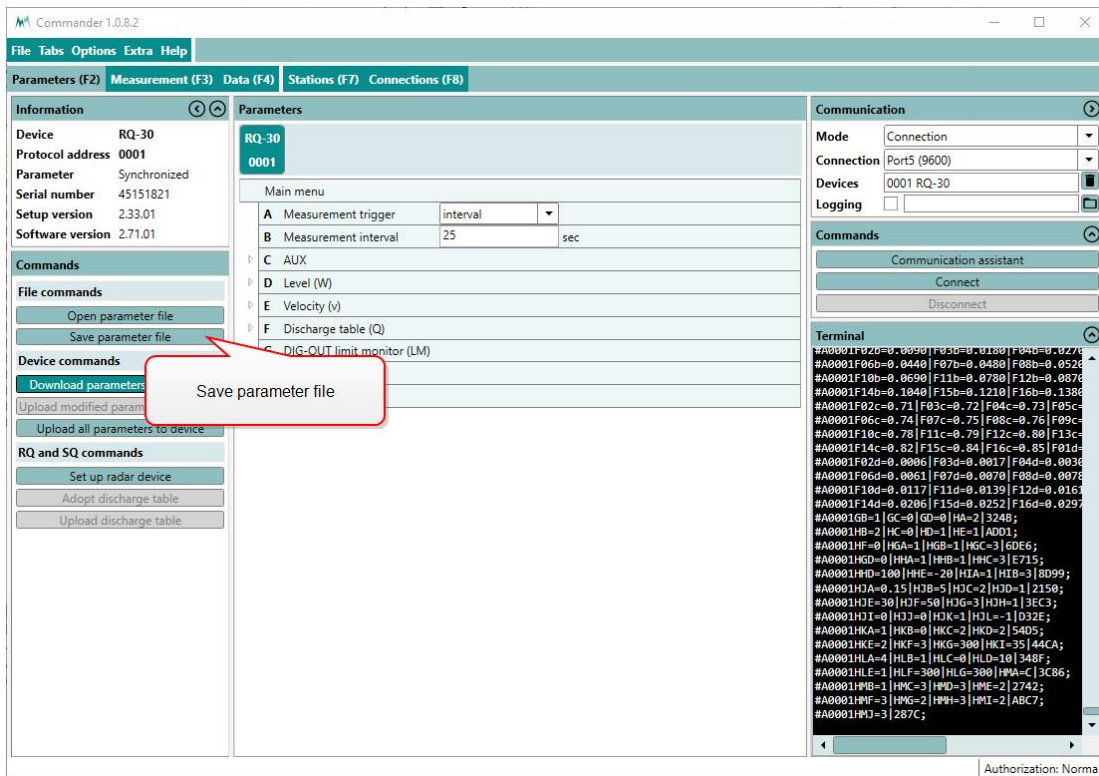

4. Adapt the parameters required for your application. Changed values are displayed with a pink background.

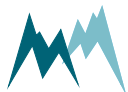
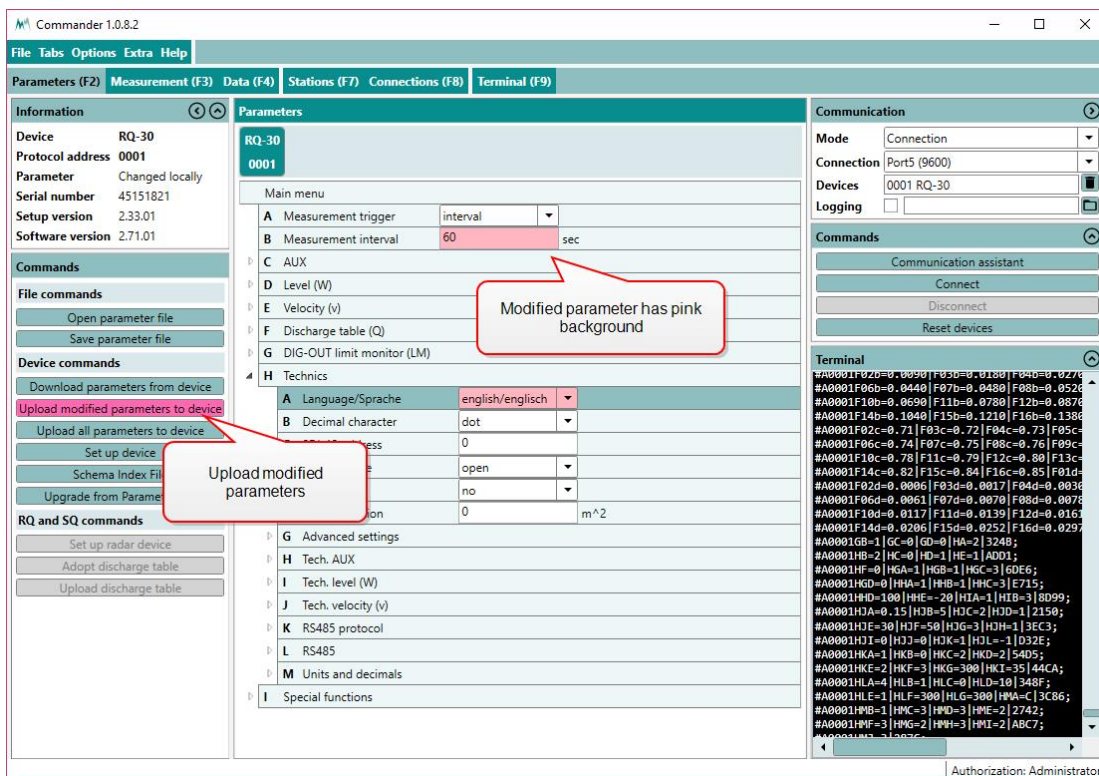

- Send the modifications to the IDS-20a by clicking [Upload modified parameters to device](#). Upon successful upload the pink backgrounds disappear again.

11.3 Configuration with a terminal program

The Commander software ships with an integrated terminal program. However, communication with the IDS-20a can be performed with any terminal program.

Follow the steps below to modify the configuration parameters of the IDS-20a:

- Establish a connection between your PC and the IDS-20a.
- In the terminal window enter three question marks (???) in quick succession. The main parameter menu is displayed in response.

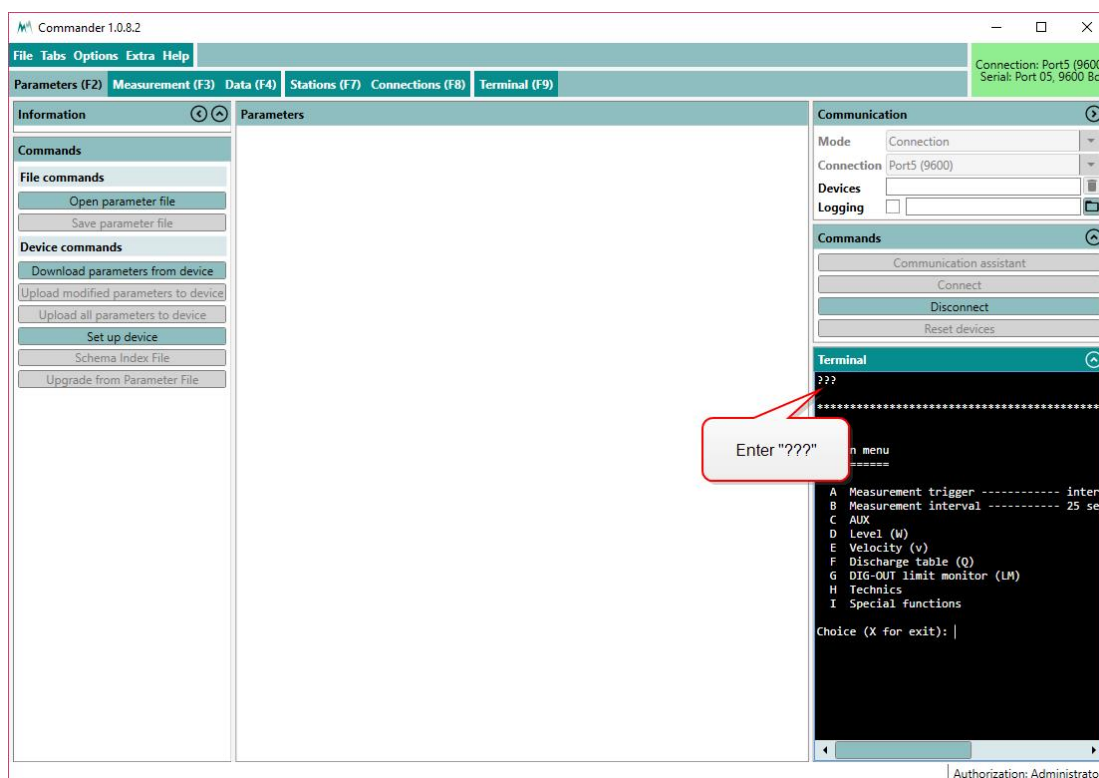

NOTE As an unwanted switching into the menu mode must be avoided the timing of the three question marks ??? is very restrictive and must never be finished with Return/Enter. This is especially important for command line tools, which automatically send a closing "Carriage return". Before and after sending ??? no communication must occur for 1 second.

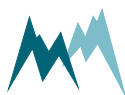

3. Read or modify the required parameters: The menu items can be selected by entering the letter assigned to each item. Upon selection a submenu is opened or the selected parameter is displayed with its unit. Changes to values are confirmed with **Return/Enter** or discarded with **Esc**. Menus are closed with **X** or **Esc**. After closing the main menu with **X** the device performs an initialization.

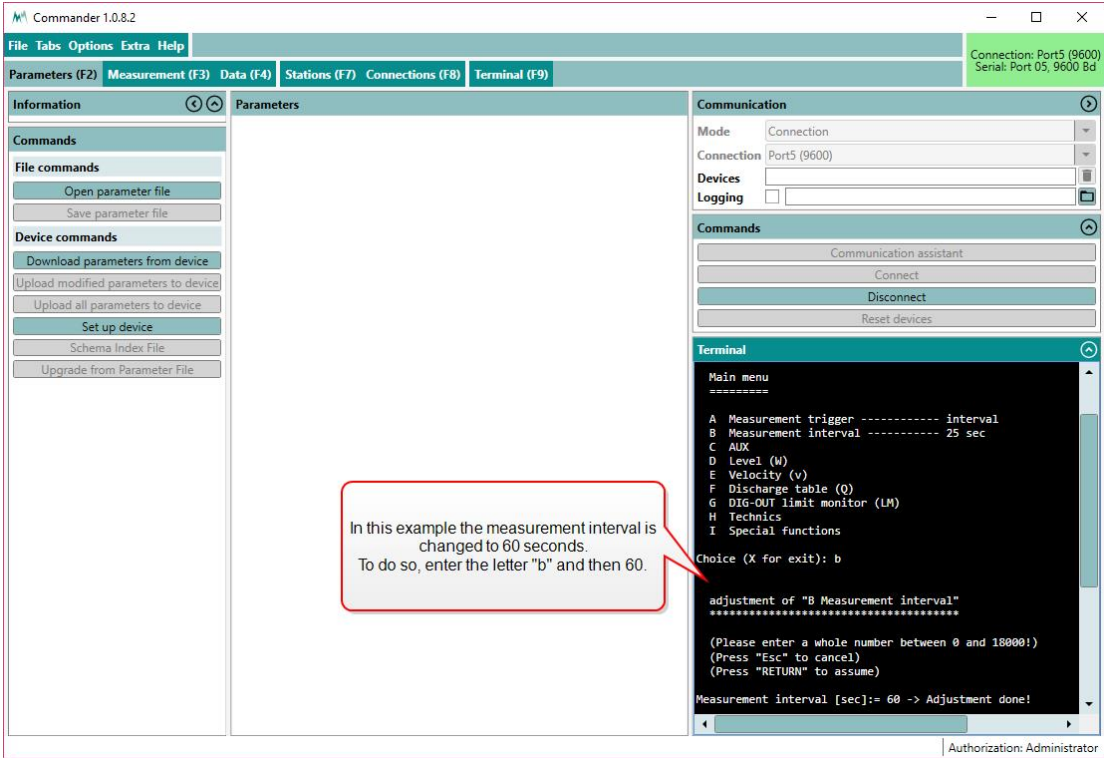

11.4 General settings

When first setting-up a IDS-20a at a measurement site, the parameters described below may need to be adapted.

11.4.1 Language/Sprache

The menu language.

11.4.2 Decimal character

The character used as decimal separator in the values of the settings, in serial data strings and in .csv files.



11.4.3 Units and decimals

The units and number of decimal digits. These have to be set prior to all other settings as all values are saved internally in this format. They are set in the parameter menu [Units and decimals](#).



ATTENTION If units or decimals are changed, related parameters may need to be adjusted.

11.4.4 Output protocol (OP)

The type of the serial output protocol. The following options are available:

| ID | Option | Description |
|----|------------------------|--|
| 1 | Sommer (SBP) (default) | Sommer protocol; data values are returned with an index starting at 1. Multiple strings may be returned. |
| 2 | Standard | Standard protocol; data values are returned without an index in one string. |
| 3 | MODBUS | Modbus protocol |

11.4.5 Information

The main measurement values are always included in the data output string. Additionally, special and analysis values can be included.

| ID | Option | Description |
|----|----------------------------|---|
| 1 | Main values | Only the main values are returned. |
| 2 | & Special values (default) | Main values and special values are returned. |
| 3 | & Analysis values | Main, special and analysis values are returned. |

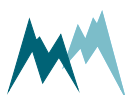

11.5 Sensor setup

11.5.1 Sensor type

The type of sensor used. One of Cube 1, Cub 5, Rod T 80 or Custom.

11.5.2 Sensor S1, orientation and Sensor S2, orientation

The orientation of the sensor relative to geographic north. Use the black mark on the cube sensor for northing.

11.5.3 Sensor S1, zero adjust and Sensor S2, zero adjust

After connection of the sensors to the IDS-20a controller it needs to be verified that the sensor cables do not introduce any interfering capacities. This can be tested with the functions [Sensor S1, test](#) and [Sensor S2, test](#), which read the currently measured capacities of all sensor plates. Use the zero adjust functions to compensate for any capacities introduced by the sensor cables.



ATTENTION The zero adjust functions should only be applied during installation with dry sensor surfaces. Do not use this function during continuous operation as this may introduce a shift of icing measurements!

11.5.4 “OFF” turn off temperature

To reduce power consumption icing measurements are switched off if ambient temperatures exceed the specified limit.



NOTE

If the ambient temperature exceeds “OFF” turn off temperature, the IDS-20a returns the following values for ice and water variables:



| Protocol | Returned value |
|----------|--------------------------|
| RS-485 | empty string |
| SDI-12 | 00000000 |
| Modbus | 10^6 , 10^7 , 10^8 |

11.6 Heater configuration

11.6.1 Ice, maximum

The maximum ice accumulation before the sensor starts heating.

11.6.2 Ice, minimum

Thickness of the accumulated ice layer at which heating stops. This limit is only active in combination with the [Water, minimum](#) setting.

11.6.3 Water, maximum

The maximum water accumulation before the sensor starts heating.

11.6.4 Water, minimum

Thickness of the accumulated water layer at which heating stops. This limit is only active in combination with the [Ice, minimum](#) setting.

11.6.5 Maximum heating time

The maximum heating duration for one heating cycle. It prevents excess heating and damage of an ice-sensor. Generally, an ice-sensor is defrosted and dried in less than the default 600 sec. Except for extremely harsh environments it is recommended to use the default value.

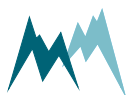

11.6.6 Cool down duration

The time required to cool down the ice-sensor to ambient conditions.

11.6.7 Meas. duration icing rate

It is recommended to determine the icing-rate over a longer period than a single measurement interval. This period can be specified with the icing-rate measurement duration.

11.7 Icing verification

With the IDS-20a icing of a connected sensor is verified by the following variables. All three conditions must be satisfied for ice to accrete on a sensor.

11.7.1 Maximum temperature

The temperature below which icing may occur. This depends on the meteorological conditions at the measurement site, e.g. wind speed, humidity or precipitation and may reach a few degrees Celsius plus.

11.7.2 Minimum humidity

The relative humidity above which icing may occur. This value may be as low as 80%.

11.7.3 Maximum water

The thickness of the water layer on the sensor below which icing may occur.

The result of the icing verification is also returned with the analysis values (indices 26 and 40). See [Measurement phases](#) for details.

11.8 Relay switching

The IDS-20a provides two relay outputs which can be configured to switch according to different limit values of the connected sensors. The wiring of the relay outputs is illustrated in [Figure 8](#).

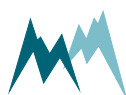

11.8.1 Output value

The variable which controls relay A and/or B; either ice, water or ice and water. Different variables of the same sensor or the same variable of both sensors can be selected.

11.8.2 Sensor choice

One of the sensors for which the limit value is monitored.

11.8.3 Ice limit

The amount of ice accreted before the relay is switched.

11.8.4 Water limit

The amount of accumulated water before the relay is switched.

11.8.5 Ice rate limit

The rate at which ice accumulates before the relay is switched.

11.8.6 Functional switch at “OFF”

The IDS-20a contains an additional relay that responds to high ambient temperatures and the state of the device. To reduce power consumption icing measurements can be switched off if ambient temperatures are too high.

Generally, if an instrument failure occurs the relay opens. The relay can also be configured to open if the ambient temperature exceeds a certain limit.



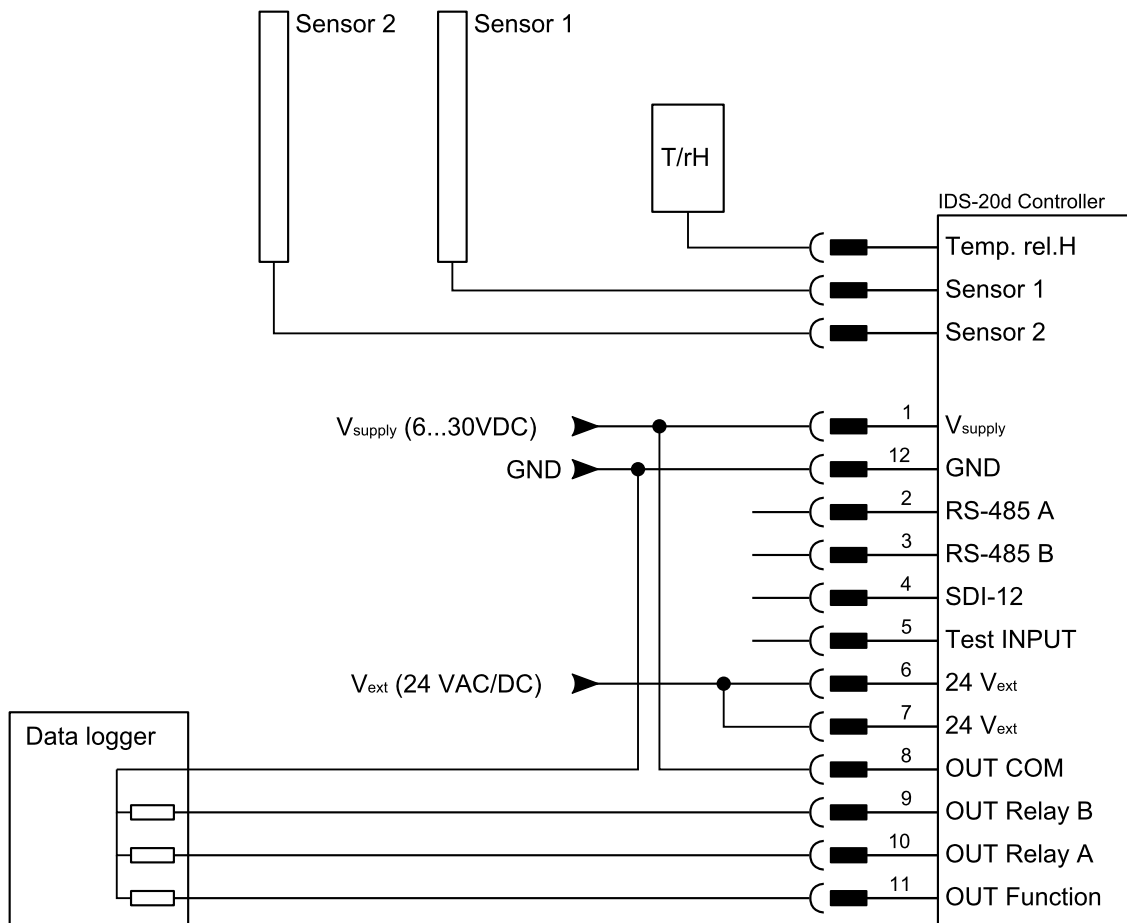
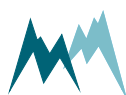

Figure 8 Wiring of relay outputs to a data logger



12 Communication

12.1 Communication protocols

The IDS-20a provides the following communication protocols:

- [RS-485](#) (Sommer bus protocol)
- [Modbus](#)
- [SDI-12](#)

12.2 Data output

The measurement values returned by the IDS-20a are arranged in a fixed sequence and identified by an index. They are divided into three groups and can be selected in [Information](#).

12.2.1 Main values

| Index | Value | Unit | Description |
|-------|--------------------|--------|---|
| 01 | Temperature | °C / F | Air temperature |
| 02 | Humidity | % | Humidity |
| 03 | Dew point | °C / F | Dew point |
| 04 | Relay A | 0 / 1 | State of relay A |
| 05 | Relay B | 0 / 1 | State of relay B |
| 06 | Relay function | 0 / 1 | State of measurement device |
| 07 | Ice | mm | Current ice layer thickness |
| 08 | Water | mm | Current water layer thickness |
| 09 | Ice rate | mm/h | Current icing rate on |
| 10 | Sensor Temperature | °C / F | Surface temperature |
| 11 | Direction | ° | Icing direction |
| 12 | Direction value | | Directional distinction of ice accretion; the higher the value the more pronounced icing is in a certain direction. |

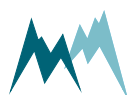

Table 2 Main values

12.2.2 Special values

| Index | Value | Unit | Description |
|-------|------------------|------|---|
| 13 | Relay A, counter | | Sum of trigger events of relay A |
| 14 | Relay A, time | h | Total time relay A is on |
| 15 | Relay B, counter | | Sum of trigger events of relay B |
| 16 | Relay B, time | h | Total time relay B is on |
| 17 | Heating current | A | Heating current |
| 18 | Supply Voltage | V | Supply voltage |
| 19 | Exception code | | for diagnostic use of Sommer Messtechnik only |

Table 3 Special values

12.2.3 Analysis values

| Index | Value | Unit | Description |
|-------|---------------------|------|---|
| 20 | Measurement phase | | Measurement phase, see see Measurement phases |
| 21 | Sensor 1, Ice | mm | Current ice layer thickness on sensor 1 |
| 22 | Sensor 1, Water | mm | Current water layer thickness on sensor 1 |
| 23 | Sensor 1, Direction | | Icing direction of sensor 1 |
| 24 | Sensor 1, Ice raw | mm | Current ice layer thickness, not verified |
| 25 | Sensor 1, C P1 LF | pF | Capacity |

| Index | Value | Unit | Description |
|-------|---------------------|------|---|
| 26 | Sensor 1, C P1 HF | pF | Capacity |
| 27 | Sensor 1, C P2 LF | pF | Capacity |
| 28 | Sensor 1, C P2 HF | pF | Capacity |
| 29 | Sensor 1, C P3 LF | pF | Capacity |
| 30 | Sensor 1, C P3 HF | pF | Capacity |
| 31 | Sensor 1, P P1 LF | ° | Phase of the electrical signal |
| 32 | Sensor 1, P P1 HF | ° | Phase of the electrical signal |
| 33 | Sensor 1, P P2 LF | ° | Phase of the electrical signal |
| 34 | Sensor 1, P P2 HF | ° | Phase of the electrical signal |
| 35 | Sensor 1, P P3 LF | ° | Phase of the electrical signal |
| 36 | Sensor 1, P P3 HF | ° | Phase of the electrical signal |
| 37 | Sensor 2, Ice | mm | Current ice layer thickness on sensor 2 |
| 38 | Sensor 2, Water | mm | Current water layer thickness on sensor 2 |
| 39 | Sensor 2, Direction | | Icing direction of sensor 2 |
| 40 | Sensor 2, Ice raw | mm | Current ice layer thickness, not verified |
| 41 | Sensor 2, C P1 LF | pF | Capacity |
| 42 | Sensor 2, C P1 HF | pF | Capacity |
| 43 | Sensor 2, C P2 LF | pF | Capacity |
| 44 | Sensor 2, C P2 HF | pF | Capacity |



| Index | Value | Unit | Description |
|-------|-------------------|------|--------------------------------|
| 45 | Sensor 2, C P3 LF | pF | Capacity |
| 46 | Sensor 2, C P3 HF | pF | Capacity |
| 47 | Sensor 2, P P1 LF | ° | Phase of the electrical signal |
| 48 | Sensor 2, P P1 HF | ° | Phase of the electrical signal |
| 49 | Sensor 2, P P2 LF | ° | Phase of the electrical signal |
| 50 | Sensor 2, P P2 HF | ° | Phase of the electrical signal |
| 51 | Sensor 2, P P3 LF | ° | Phase of the electrical signal |
| 52 | Sensor 2, P P3 HF | ° | Phase of the electrical signal |

Table 4 Analysis values

12.2.4 Exception values

Measurement data may be returned with the following exception values:

| Value | Description |
|-----------|---|
| 99999998 | Initial value: No measurement has been performed yet. |
| 99999997 | Conversion error: Caused by a technical problem. |
| 99999999 | Positive overflow |
| -99999999 | Negative overflow |

Table 5 Exception values

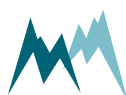

12.3 RS-485

12.3.1 What is RS-485?

RS-485 is a serial communication method for computers and devices. It is currently a widely used communication interface in data acquisition and control applications where multiple nodes communicate with each other.¹

12.3.2 What can I do with it?

RS-485 communication is primarily used to trigger measurements and read their results. It also permits to change parameters of the IDS-20a.

12.3.3 Configuration

The IDS-20a has serial RS-485 communication enabled by default. If the device is integrated into a RS-485 network or connected to a stand-alone data acquisition system, e.g. a data logger, the parameters listed in [Output protocol](#) may need to be adapted.

System key and device number

The system key and device number are used to identify a IDS-20a in a bus system. This is essential if multiple devices (IDS-20a and data loggers) are operated within the same system.

System key

The system key separates different conceptual bus systems. This may be necessary if the remote radio coverage of two measurement systems overlap. In wired setups, the system key should be set to *00*.

Device number

The device number is a unique number that identifies a device in a bus system.



ATTENTION Do not use a device number twice in your bus system! Otherwise communication will fail!

¹<https://www.lammertbies.nl/comm/info/RS-485.html>

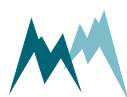

Measurement output

The serial data output can be triggered in the following ways:

| ID | Option | Description |
|----|-----------------------------|--|
| 1 | Just per command | The output is only requested by commands via RS-485. |
| 2 | After measurement (default) | The serial data output is performed automatically right after each measurement. |
| 3 | Pos. TRIG slope | The output is triggered by a positive edge of a control signal applied to the trigger input. |



NOTE If **Measurement output** is set to *pos. TRIG slope*, the data are returned with a delay of 200 ms after the trigger has been set. Make sure that your data acquisition system takes account of this lag to ensure that it receives the most recent data.

Operation modes

The selected combination of measurement trigger and output time determines the following operation modes:

| Parameter | Mode | | |
|------------------------|-------------------|----------------------------|----------------------------|
| | Pushing | Polling | Apparent polling |
| Measurement trigger | internal | TRIG input SDI-12/RS485 | TRIG input SDI-12/RS485 |
| OP, measurement output | after measurement | just per command | after measurement |

Waking-up a connected data logger

The IDS-20a supports wake-up of a connected data logger that is in standby mode. Generally, this feature is only used in pushing mode and can be set under [Wake-up sequence](#).

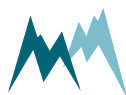

Sync sequence

The sync sequence is the string `UU~??` and is sent directly before a command. It is used to synchronize the receiving UART.

Prefix

The prefix is an arbitrary character; the IDS-20a uses a blank. This character is sent prior to any communication. Then the time of the [Prefix holdback](#) is waited and the command is sent afterwards. With this procedure the receiving device has time to wake-up.

Output protocols

For data output via RS-485 different protocols are available, which can be selected under [Output protocol \(OP\)](#).

12.3.4 Data output options

Data are returned in two different formats, selectable in [Output protocol \(OP\)](#):

- [Sommer bus protocol \(SBP\)](#)
- [Standard protocol](#)

12.3.5 Sommer bus protocol (SBP)

The data string of the Sommer protocol has the following format:

 **EXAMPLE** #M0001G01se01 1461|02 1539|03 25.25|04
0|3883;

A data string contains max. 8 values and is max. 105 characters long.

Header

The header (`#M0001G00se`) identifies the data by system key, device number and string number.

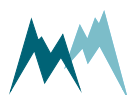

| Parameter | Format | Description |
|-----------------|--------|---|
| Start character | # | |
| Identifier | M | M identifies an output string |
| System key | dd | |
| Device number | dd | |
| Command ID | G | G defines an output string with string number |
| String number | dd | 01 Main values 03 Special values 05 Analysis values 06 Analysis values |
| Command | se | se identifies automatically sent values |

Table 6 Header of the Sommer protocol

Measurement value

A measurement value (02 1539 |) has a length of 8 digits and is returned together with its index. If the measurement value is a floating point number, one digit is reserved for the decimal character. Values are returned right-aligned, so blanks may occur between index and value.

| Parameter | Format | Description |
|-----------|----------|---------------------------|
| Index | dd | 2 numbers |
| Value | xxxxxxxx | 8 character right-aligned |
| Separator | | |

Table 7 Values in Sommer protocol

End sequence

The data string is terminated with a CRC-16 in hex format (3883) followed by an end character and <CR><LF>. The CRC-16 is described in [Sommer CRC-16](#).

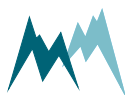

| Parameter | Format | Description |
|--------------------|----------|-------------------------------|
| CRC-16 | Hhhh | 4-digit hex number |
| End character | ; | |
| Control characters | <CR><LF> | Carriage return and Line feed |

Table 8 End sequence of the Sommer protocol

Example Sommer protocol

Main values

Main values are returned as in the following example:

| | | | | |
|---|----------------|---------|---------|--|
|  | EXAMPLE | | | |
| #M0001G01se01 | 25.4 02 | 41.6 03 | 11.4 04 | |
| 0 05 | 0 06 | 1 577C; | | |
| #M0001G02se07 | 0.00 08 | 0.05 09 | 0.00 10 | |
| 24.5 11 | 12 | B9B7; | | |

| | |
|-------------|--|
| #M0001G01se | Header with system key 00, device number 01 and string number 01 |
| 01 25.4 | Air temperature |
| 02 41.6 | Humidity |
| 03 11.4 | Dew point |
| B9B7; | Closing sequence |

Table 9 Main values in Sommer protocol

Special values

Special values are returned as in the following example:

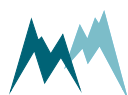



EXAMPLE #M0001G10se13 125|14 70.0|15 112|16
61.6|17 -0.01|18 11.69|19 0.32|2579;

| | |
|--------------|--|
| #M0001G10se | Header with system key 00, device number 01 and string number 10 |
| 13 125 | Relay A, counter |
| 14 70.0 | Relay A, time |
| 15 112 | Relay B, counter |
| ... | ... |
| 2579; | Closing sequence |

Table 10 Special values in Sommer protocol

Analysis values

Analysis values are returned as in the following example:



EXAMPLE
#M0001G21se27 30.05|28 30.25|29 30.10|30
30.29|31 -89.95|32 -88.70|33 -89.94|9BC2;
#M0001G22se34 -88.65|35 -89.96|36 -88.86|37
0.00|38 0.01|39 0|40 0.00|6240;
#M0001G23se41 89.37|42 89.76|43 89.09|44
89.43|45 89.75|46 90.15|47 -89.94|4821;
#M0001G24se48 -89.86|49 -89.91|50 -89.79|51 -
89.93|52 -89.86|AF77;

| | |
|---------------|--|
| #M0001G20se | Header with system key 00, device number 01 and string number 20 |
| 27 30.05 | Measurement phase |
| 28 30.25 | Sensor 1, Ice |

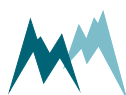

| | | |
|-------|-------|------------------|
| 29 | 30.10 | Sensor 1, Water |
| ... | | ... |
| AF77; | | Closing sequence |

Table 11 Analysis values in Sommer protocol

12.3.6 Standard protocol

The data string of the Standard protocol has the following format:

| | | | | | | |
|---|----------------|--------|------|------|-------|---|
|  | EXAMPLE | M_0001 | 1461 | 1359 | 25.38 | 0 |
|---|----------------|--------|------|------|-------|---|

Header

The header (M_0001) identifies the data by system key and device number.

| Parameter | Format | Description |
|---------------|--------|--|
| Identifier | X_ | M_ Measurement values S_ Special values V_ Analysis values |
| System key | Dd | |
| Device number | Dd | |

Table 12 Header of the Standard protocol

Measurement values

Measurement values are returned in sequence and are separated by a blank. A measurement value has a length of 8 digits. If the measurement value is a decimal number, one digit is reserved for the decimal character. Values are returned right-aligned, so additional blanks may be returned between values.

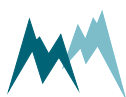

| Parameter | Format | Description |
|-----------|----------|---------------------------|
| Separator | [blank] | blank |
| Value | xxxxxxxx | 8 character right-aligned |

Table 13 Values in Standard protocol



NOTE With the standard protocol the data strings can be very long. In contrast, the strings of the Sommer protocol are max. 105 characters long.

End sequence

The data string is terminated with <CR><LF>.

Example Standard protocol

Main values

Main values are returned as in the following example:

| | | | | | | |
|---|----------------|--------|------|------|------|------|
| ✓ | EXAMPLE | M_0001 | 25.5 | 41.2 | 11.4 | 0 |
| | | 0 1 | 0.00 | 0.05 | 0.00 | 24.6 |

| | |
|--------|---|
| M_0001 | Header with identifier for measurement values |
| 25.5 | Temperature |
| 41.2 | Humidity |
| 11.4 | Dew point |
| ... | ... |

Table 14 Main values in Standard protocol

Special values

Special values are returned as in the following example:

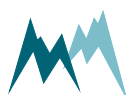



EXAMPLE S_0001 125 70.0 112 61.6
 -0.01 11.66 0.32

| | |
|--------|---|
| S_0001 | Header with identifier for measurement values |
| 125 | Relay A, counter |
| 70.0 | Relay A, time |
| 112 | Relay B, counter |
| 61.6 | Relay B, time |
| ... | ... |

Table 15 Special values in Standard protocol

Analysis values

Analysis values are returned as in the following example:



EXAMPLE V_0001 1.661 0.00 0.00 0
 0.00 30.01 30.20 30.05 30.23 30.09
 30.28 -89.94 -88.68 -89.93 -88.63 -89.97 -
 88.85 0.00 0.01 0 0.00 89.36
 89.71 89.09 89.42 89.74 90.13 -89.94 -
 89.85 -89.91 -89.78 -89.92 -89.84

| | |
|--------|--|
| V_0001 | Header with identifier for analysis values |
| 1.661 | Sensor 1, Ice |
| 0.00 | Sensor 1, Water |
| 0.00 | Sensor 1, Direction |
| 0 | Sensor 1, Ice raw |
| ... | ... |

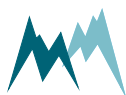

Table 16 Analysis values in Standard protocol

12.3.7 RS-485 commands

Command structure

The structure of serial commands and answers is described in the following table:

| Parameter | Format | Description |
|-----------------|--------|--|
| Start character | # | |
| Identifier | X | <p>W Write: IDS-20a returns a confirmation on receipt. This command type demands a closing sequence with a valid CRC-16.</p> <p>S Silent: IDS-20a does not acknowledge the receipt of the command. This command type demands no closing sequence and therefore no CRC-16.</p> <p>R Read: IDS-20a returns the requested measurement value or parameter. This command type demands a closing sequence with a valid CRC-16.</p> <p>T Temporary: Write a volatile, temporary setting and receive a confirmation.</p> <p>A Answer: Answer of device to read or write command.</p> |
| System key | dd | |
| Device number | dd | |
| Command | xxx | See table in section Commands . |
| Separator | | |
| CRC-16 | hhhh | 4-digit hex number |
| End character | ; | |

Table 17 Structure of Sommer bus commands and answers

Commands

The following commands can be used with the IDS-20a:

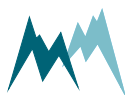

| Command | Description |
|---------|--|
| \$mt | Trigger a measurement |
| \$pt | Return measurement values |
| XX | Read a parameter with identifier XX |
| XX=xxxx | Write a parameter with identifier XX and the value xxx |

Table 18 List of Sommer bus commands

Trigger a measurement

The command \$mt triggers a complete measurement sequence as in the following example:

 **EXAMPLE** #W0001\$mt|BE85; Answer: #A0001ok\$mt|4FA9;

Read a parameter value

Read measurement interval (in the example below the menu item B):

 **EXAMPLE** #R0001B|228E; Answer: #A0001B=300|F8B3;

Request a complete data string

The command \$pt requests a data string as in the following example:

 **EXAMPLE**

Option 1
#W0001\$pt|7D19; Answer: #A0001ok\$pt|8C35;

Option 2
#S0001\$pt| Answer: none

The data string is returned as soon as the IDS-20a has processed the command. If a wrong command is entered, the device returns #A0001na\$pt|3D40;.

Request a single measurement value

The reading command `R` together with the index of the requested measurement returns a single measurement value. In the following example the measurement value with index 01 (in this example a water level) is requested:



EXAMPLE

```
#R0001_010cv|EA62;
```

```
Answer: #A0001ok_010cv1461 |07EB;
```

12.3.8 Sommer CRC-16

The CRC-16 (cyclic redundancy check) used in data transmission of Sommer devices is based on the ZMODEM protocol. When data are exchanged between two devices the receiving device calculates the CRC-value. This value is compared to the CRC value sent by the other device to check if the data were transmitted correctly. Please refer to technical literature or contact Sommer for calculation of CRC-16 values.

You can [here](#) calculate the CRC of a command online .

If you need to compute CRCs automatically, you can implement the following procedure in your data logger or controller software.

The CRC-16 is calculated character by character. The start value for the initial CRC-16 calculation is always 0.

The following procedure returns the CRC-16 of a single character:

```
byte1 = CRC-16 right shift by 8 bits           upper byte disappears  
uint1 = c                                     new character, upper byte = 0  
uint2 = CRC-16 left shift by 8 bits           lower byte = 0  
uint3 = crc16tab[byte1]                       Table value from the CRC-16 table  
Crc16 = uint3 (excl. or) uint2 (excl. or) uint1
```

Computation CRC-16 in C/C++

```
1 | crc16 = crc16tab[(unsigned char)(crc16>>8)] ^ (crc16<<8) ^ (unsigned int)(c);
```

The `crc16tab` array is listed in [CRC-16 array](#).

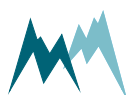



EXAMPLE

Command to request measurement data `#W0001$pt|7D19;`

The first character is #, the last |. The CRC-16 of the command is 7D19 and its end character is ;.

The CRC-16 is calculated sequentially with the start value 0 for the initial CRC-16 calculation:

| Position | String | CRC-16 |
|----------|------------|--------|
| Start | | 0000 |
| 0 | # | 0023 |
| 1 | #W | 2357 |
| 2 | #W0 | 4331 |
| 3 | #W00 | 4997 |
| 4 | #W000 | 4EDD |
| 5 | #W0001 | 743B |
| 6 | #W0001\$ | 0537 |
| 7 | #W0001\$p | 67D5 |
| 8 | #W0001\$pt | C935 |
| 9 | #W0001\$pt | 7D19 |

12.4 SDI-12

12.4.1 What is SDI-12?

SDI-12 (Serial Data Interface at 1200 Baud) is a serial data communication standard for interfacing multiple sensors with a single data recorder. For a detailed description on SDI-12 communication please refer to www.sdi-12.org.

12.4.2 What can I do with it?

The IDS-20a listens to standard SDI-12 commands as listed in the SDI-12 specifications of version 1.3, e.g., to trigger a measurement or retrieve measurement results. Additionally, a set of extended SDI-12 commands is implemented in all SOMMER sensors for instrument configuration.

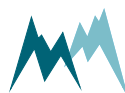

12.4.3 Configuration

The IDS-20a has SDI-12 communication enabled by default. When setting up a SDI-12 network take the following considerations into account:

- Each device in the SDI-12 network must have a unique address, e.g. data logger address *0*, IDS-20a address *1*.
- The IDS-20a operates in pushing mode and data are retrieved by `R!` commands.
- When multiple sensors are connected to the same network, data acquisition should be done in sequence, i.e., data should have been received from the first sensor before triggering the measurement of the second sensor.
- Most data loggers control the timing of messages (marking and spacing) automatically. If this is not the case, please refer to www.sdi-12.org.

12.4.4 Data structure

The answer from the SDI-12 device is a string containing the sensor address, the requested data and a terminating carriage return/line feed.

In a string containing measurement data, the measurements are returned in the same order as listed by the index in [Data output](#).



EXAMPLE

```
0+2591+706+25.53+62<CR><LF>
```

| Value | Content |
|-------|---------------------------|
| 0 | Sensor address |
| 2591 | Measurement with index 01 |
| 706 | Measurement with index 02 |
| 25.53 | Measurement with index 03 |
| 62 | Measurement with index 04 |

If a device returns more than 9 measurement values, or if the values are returned in groups (see also [Request results](#)) the measurement index increments in the next group.



EXAMPLE

```
0D0! Answer: 0+2591+706+25.53+62<CR><LF>
```

```
0D0! Answer: 0+56.2+125+12.32<CR><LF>
```

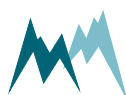



| Value | Content |
|-------|---------------------------|
| 0 | Sensor address |
| 2591 | Measurement with index 01 |
| 706 | Measurement with index 02 |
| 25.53 | Measurement with index 03 |
| 62 | Measurement with index 04 |
| 0 | Sensor address |
| 56.2 | Measurement with index 05 |
| 125 | Measurement with index 06 |
| 12.32 | Measurement with index 07 |

12.4.5 SDI-12 commands

The following tasks can be performed with standard and extended SDI-12 commands.

Extended SDI-12 commands are non-standard commands implemented by SOMMER to enable device configuration via SDI-12.



NOTE After any changes, the settings have to be adopted with the command `aXW_ts|!`, with `a` the sensor address.

Command structure

A standard SDI-12 command starts with the sensor address and ends with an exclamation mark, e.g., `0M!` to trigger a measurement.

Configuration commands contain additional information; see the sections below for details.

Identify device

The identification of a SDI-12 device is requested with the command `aI!`, with `a` the sensor address.



EXAMPLE

`0I! Answer 013Sommer USH 140r90 USH-9 <CR><LF>`

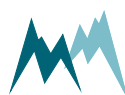



The answer contains the following information:

| | |
|---------|---|
| 0 | SDI-12 address |
| 1 | SDI-12 version prior to the point |
| 3 | SDI-12 version after the point |
| Sommer | Description of the company (6 characters and 2 blanks) |
| USH | Description of the firmware (5 characters and 2 blanks) |
| 140r90 | Firmware version (6 characters and 2 blanks) |
| IDS-20a | Device designation (max. 13 characters) |

Acquire measurements

To acquire a measurement from a sensor, two individual SDI-12 commands – trigger a measurement and request measurement values – need to be sent.



EXAMPLE

0M! Answer: 00084<CR><LF> and 0<CR><LF> after 8 seconds

0D0! Answer: 0+2591+706+25.53+0<CR><LF>

The first values in the response to the aDn! command is the sensor address.

Trigger measurement

The command aM! with sensor address a triggers a measurement as in the example below.

The response states the measurement duration and the number of measurement values (see example below). After completion of the measurement, the device will return an additional a<CR><LF>, with a the sensor address.



EXAMPLE

0M! Answer: 00084<CR><LF> and 0<CR><LF> after 8 seconds

The answer contains the following information:

0 SDI-12 address





| | |
|-----|--|
| 008 | Duration of the measurement in seconds |
| 4 | Number of measurement values |

Request results

After each measurement, results are requested with the command `aDn!`, with `a` the sensor address and `n` the index of the returned data string.



EXAMPLE `0D0!` Answer: `0+2591+706+25.53+0<CR><LF>`

The leading `0` of the response is the sensor address.

Generally, the command `aD0!` is sufficient to request up to 9 measurement values. If more than 9 values need to be read, or if the values are returned in groups, the commands `aD1!`, `aD2!`,... may need to be issued after `aD0!`. For example, if a measurement returns 8 values in two groups of 4, the commands `aD0!` and `aD1!` need to be issued to receive all values.

Acquire continuous measurements

If the SDI-12 device is operating in continuous measurement mode (not polled by SDI-12), the command `aR0!` will request and return the current reading of the sensor. The values within the data string follow the order listed in the measurement table. The first values in the response to the `aRn!` command is the sensor address.



EXAMPLE
`0R0!` Answer: `0+2591+706+25.53+0<CR><LF>`

If more than 9 values need to be read, or if the values are returned in groups, the commands `aR1!`, `aR2!`,... may need to be issued after `aR0!`. For example, if a measurement returns 8 values in two groups of 4, the commands `aR0!` and `aR1!` need to be issued to receive all values.

Configure parameter

The configuration parameters of a SOMMER sensor are read with the command `aXRpp!` and written with the command `aXWpp=vvv!`, with `a` the sensor address, `pp` the parameter identifier and `vvv` the value of the parameter.



Read and write a parameter



EXAMPLE

Reading of measurement interval (in this example menu item B)

0XRB|! Answer: 0B=300|<CR><LF>

Setting of measurement interval to 60 s (in this example menu item B)

0XWB=60|! Answer: 0B=60|<CR><LF>

Read and write a selector-parameter

Changing the measurement trigger (in the following example menu item A) from *interval* to *SDI-12/RS485*:



EXAMPLE

0XRA|! Answer: 0A=1|<CR><LF>

0XWA=3|! Answer: 0A=3|<CR><LF>

Read and write a parameters of a table

Some SOMMER sensors are equipped with multiple transducers and their settings are listed in a table (see example below). A value within such a table is addressed by its row-index (01, 02 ...) and column-index (A, B ...). A corresponding SDI-command has the following format:



EXAMPLE

In this example of a snow scale the value in row 01 and column B of the parameter D-D-E is changed to -1.4.

0XWDDE01B=-1.4|! Answer: 0DDE01b=-1.4|<CR><LF>

| | Identifier | offset zero kg | gain | zero default kg | gain default |
|----|-------------|-------------------|----------|--------------------|--------------|
| 01 | Load Cell 1 | -1.4 | 0,997787 | 0,000 | 0,997787 |
| 02 | Load Cell 2 | 0,000 | 0,997787 | 0,000 | 0,997787 |
| 03 | Load Cell 3 | 0,000 | 0,997787 | 0,000 | 0,997787 |
| 04 | Load Cell 4 | 0,000 | 0,997787 | 0,000 | 0,997787 |

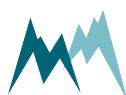

Adopt settings

Some settings need to be adopted with the command `aXW_ts|!`, with `a` the sensor address. It is recommended to issue `aXW_ts|!` after each configuration change.

12.5 Modbus

12.5.1 What is Modbus?

Modbus is a serial communication protocol used for transmitting information over serial lines between electronic devices. The device requesting the information is called the Modbus Master and the devices supplying information are Modbus Slaves. In a standard Modbus network, there is one Master and up to 247 Slaves, each with a unique Slave Address from 1 to 247. The Master can also write information to Slaves.

Modbus has become a standard communication protocol in industry, and is now the most commonly available means of connecting industrial electronic devices. It is often used to connect a supervisory computer with a remote terminal unit (RTU) in supervisory control and data acquisition (SCADA) systems. Versions of the Modbus protocol exist for serial lines (Modbus RTU and Modbus ASCII) and for Ethernet (Modbus TCP).¹

12.5.2 What can I do with it?

Modbus-communication with IDS-20a allows reading of measurement values and device information by a Modbus master. Additionally, the basic RS-485 port settings can be written to the IDS-20a.

12.5.3 Wiring

For Modbus communication the IDS-20a is wired according to the table below.

| Modbus | Connector MAIN | Connection wire | Description |
|----------|----------------|-----------------|-------------|
| Common | Pin 1 | White | GND |
| D1 - B/B | Pin 4 | Yellow | RS-485 A |
| D0 - A/A | Pin 5 | Grey | RS-485 B |

¹<http://www.simplymodbus.ca/FAQ.htm>

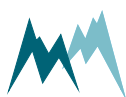

**NOTE**

Please note that different signal notations are in use for RS-485 connections:

TX+/RX+ or D+ or D1 as alternative for B

TX-/RX- or D- or D0 as alternative for A



NOTE If the IDS-20a is operated with multiple Modbus devices within the same network, termination resistors may be required. Please contact Sommer Messtechnik for details.

12.5.4 Modbus configuration

Follow the instructions below to change the communication of a Sommer-device (in this example a RG-30) to Modbus:

1. Connect the USB to RS-485 converter to the data cable of the Sommer-device and a USB port on your PC.
2. Connect the sensor to a power supply with the specified rating.
3. Start the Commander software on your PC.
4. Establish a connection to the Sommer-device.
5. Download the sensor's parameters in the **Parameters (F2)** tab and save the parameter list on your PC.

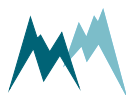

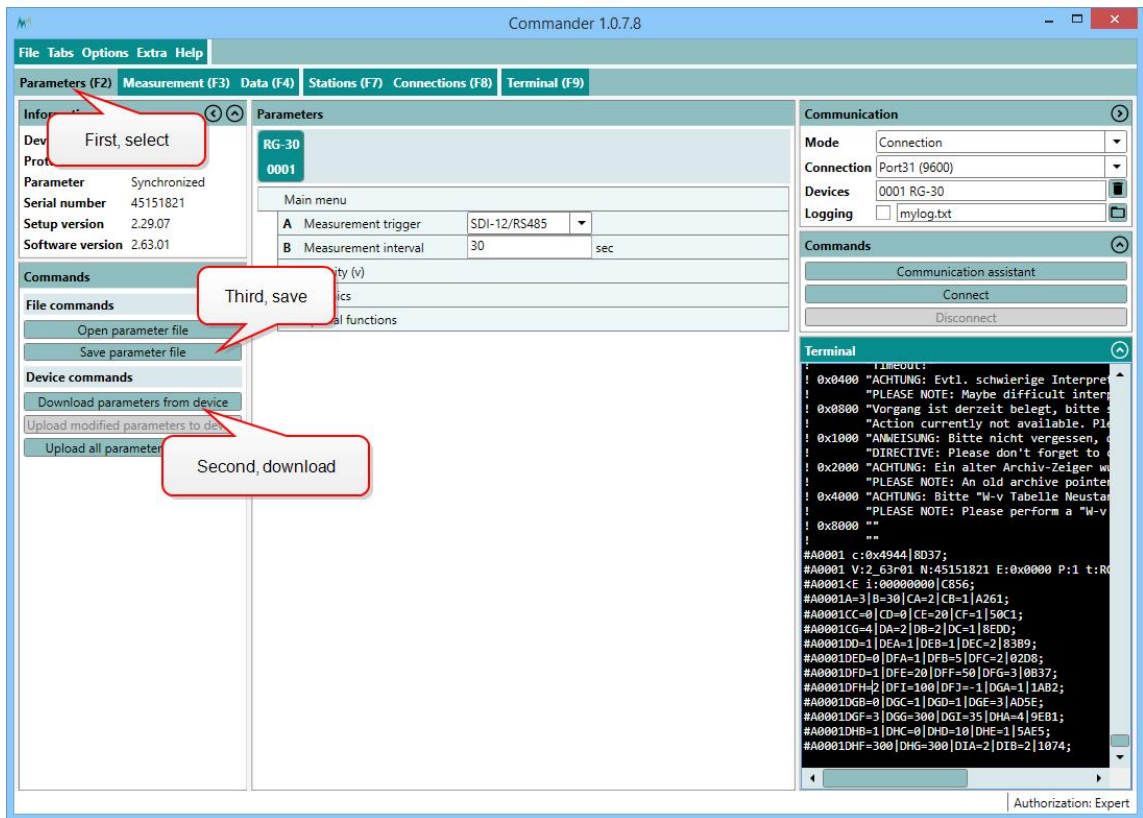

- In the parameter list navigate to Technics and open the menus **RS-485 protocol** and **RS485** and take a screenshot of the associated parameters. This and the previous step are helpful if you need to switch back to the standard communication mode at a later time.

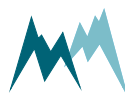

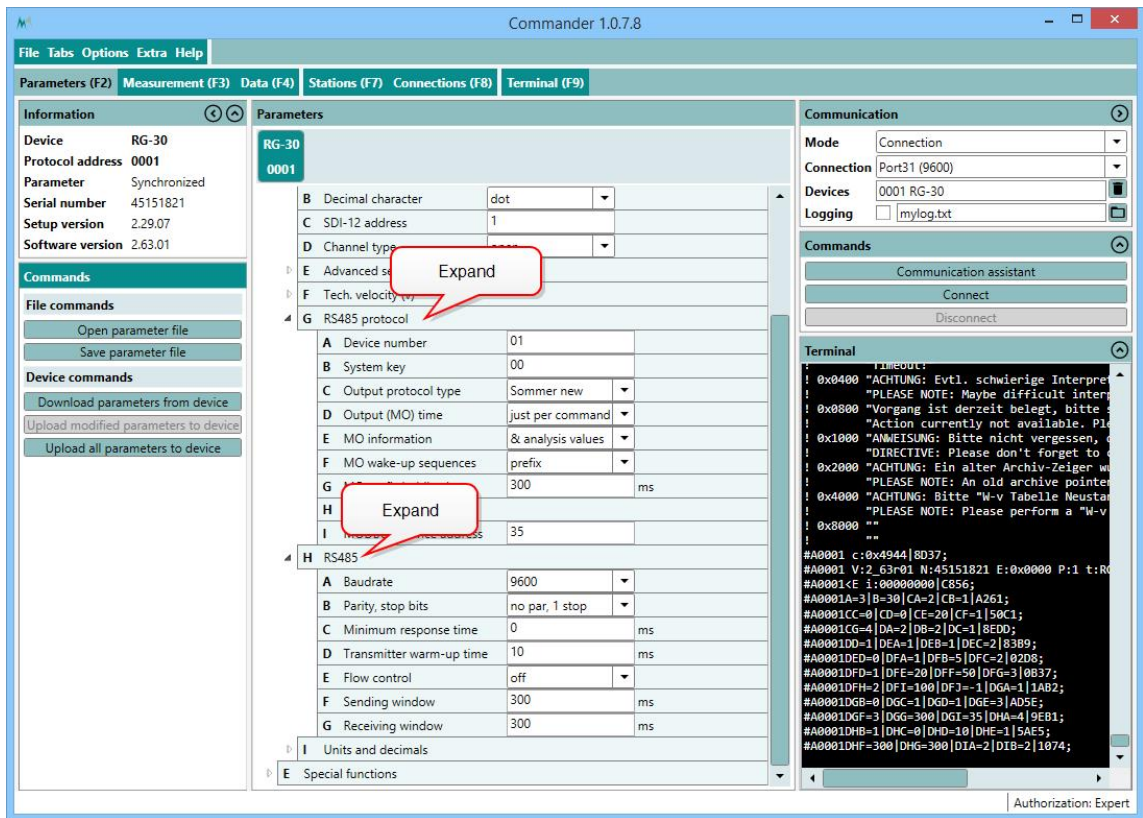

7. Set **Measurement trigger** to one of the following options:
 - A. *Interval*, if measurements are triggered internally by the device.
 - B. *SDI-12/RS-485*, if measurements are triggered by SDI-12.
 - C. *TRIG input*, if measurements are triggered by a trigger input.
 - D. *all allowed*, if measurements are triggered by one of the previous options.



NOTE Modbus cannot trigger measurements! Make sure to use the trigger option suitable for your application!

8. Verify that the connection to the Sommer-device is active and click into the Terminal window. Type `???` to enter the sensor-menu.

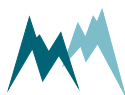

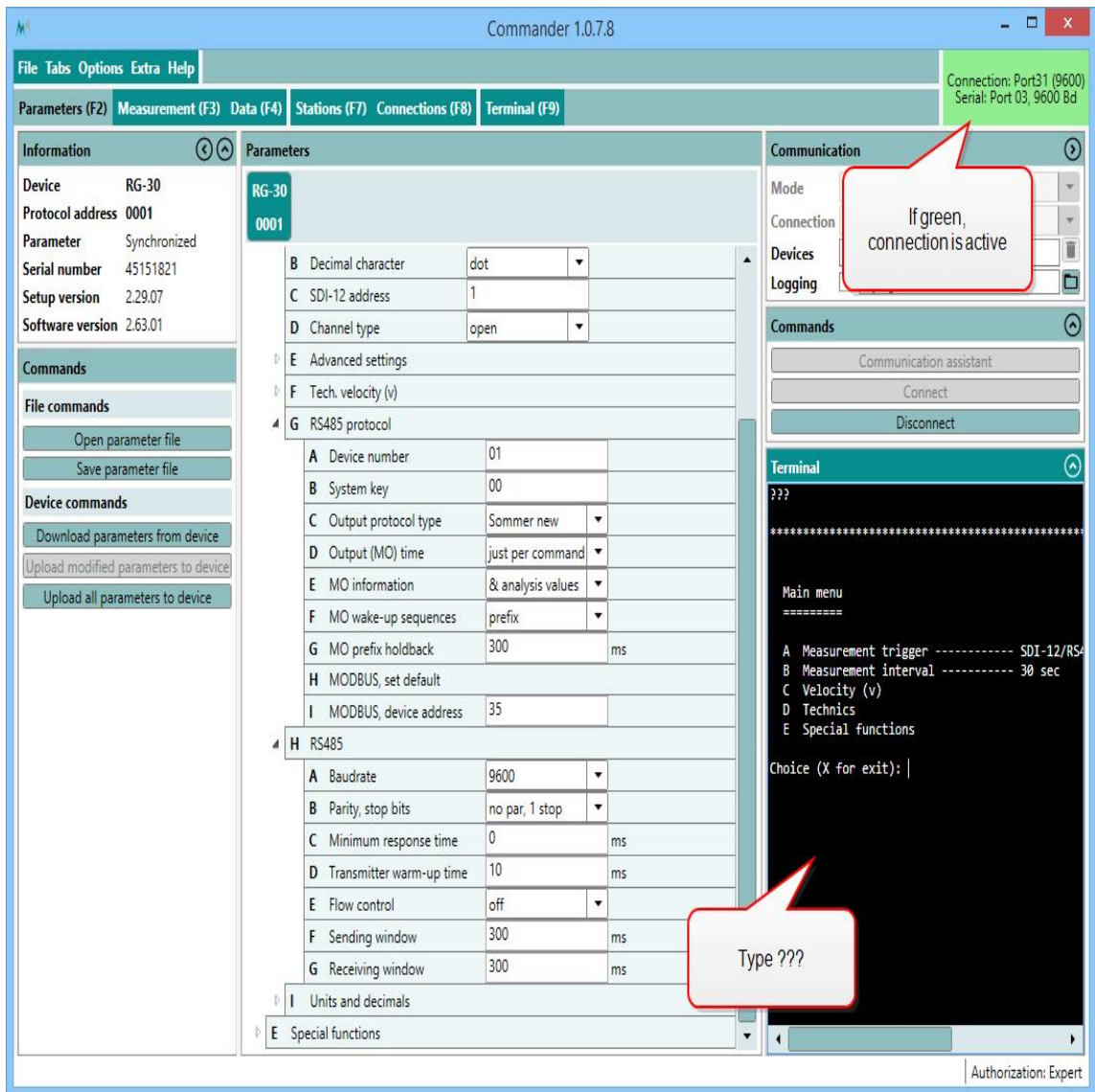

- Navigate to *RS485 protocol* and select *MODBUS, set default...* Please note, that the index-letters might be different for your Sommer-device!

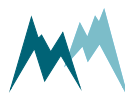

```

Terminal

Main menu
=====

A Measurement trigger ----- SDI-12/RS485
B Measurement interval ----- 30 sec
C Velocity (v)
D Technics
E Special functions

Choice (X for exit): d

Technics
=====

A Language/Sprache ----- english/englisch
B Decimal character ----- dot
C SDI-12 address ----- 1
D Channel type ----- open
E Advanced settings
F Tech. velocity (v)
G RS485 protocol
H RS485
I Units and decimals

Choice (X for exit): g

RS485 protocol
=====

A Device number
B System key --
C Output protocol
D Output (MO) t
E MO information
F MO wake-up se
G MO prefix holdback ----- 100 ms
H MODBUS, set default...
I MODBUS, device address ----- 35

Choice (X for exit): |

```

Enter the letter of 'MODBUS, set default ...'

10. Acknowledge the safety-note.

```

Start up testmode: 0x09

MODBUS, set default
AAAAAAAAAAAAAAAAAAAA

PLEASE NOTE: This process changes to 19200 baud, even parity, ...
DIRECTIVE: Please don't forget to change the serial counterpart too!

Are you sure?

(Press "RETURN" to assume)
(Press "Esc" to cancel)

```

Press Enter

11. After completion the following message will be displayed:

```

=> Testmode finished!
=> DIRECTIVE: Please don't forget to change the serial counterpart too!

```

12. Enter X until you get back to the main menu. The Sommer-device is now restarted and available for Modbus-communication. As the connection-parameters have been changed to Modbus, the connection to the sensor is lost. Press Disconnect for completion.

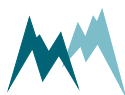

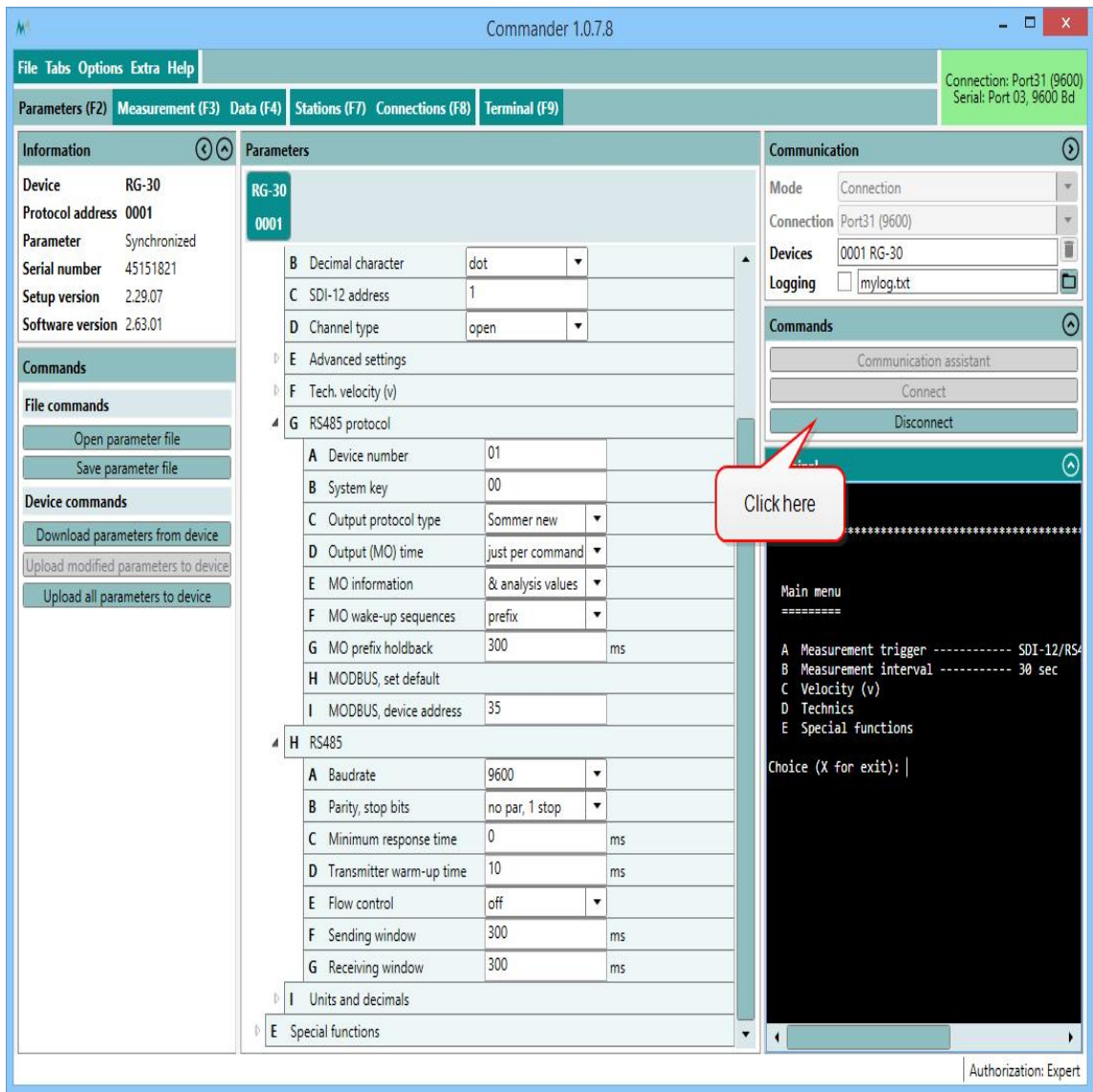

NOTE

By switching communication to Modbus with **MODBUS, set default** the following parameters are changed:

| Parameter | Modbus setting |
|--------------------------|------------------|
| OP, measurement output | just per command |
| Output protocol (OP) | Modbus |
| MODBUS, device address | 35 |
| Sleep mode | Modbus, slow |
| Parity, stop bits | even par, 1 stop |
| Baud rate | 19200 |
| Flow control | off |
| Transmitter warm-up time | 10 ms |

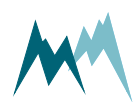



Parameter

Modbus setting

Minimum response time

30 ms



TIP To change a parameter in the **Technics** menu you need to change your Commander-authorization to Expert. See [Change authorization](#) for instructions.

12.5.5 Modbus commands and registers

Read input registers

Input registers contain measurement values. The content of these registers is updated after each measurement.

| | Index | Register address | Variable | Unit / value | Bytes | Format |
|------------|-------|------------------|----------------------|--------------|-------|--------|
| Test value | | 0 | Hardcoded test value | 2.7519... | 4 | float |
| Main | 01 | 2 | Temperature | °C / F | 4 | float |
| Main | 02 | 4 | Humidity | % | 4 | float |
| Main | 03 | 6 | Dew point | °C / F | 4 | float |
| Main | 04 | 8 | Relay A | 0 / 1 | 4 | float |
| Main | 05 | 10 | Relay B | 0 / 1 | 4 | float |
| Main | 06 | 12 | Relay function | 0 / 1 | 4 | float |
| Main | 07 | 14 | Ice | mm | 4 | float |
| Main | 08 | 16 | Water | mm | 4 | float |
| Main | 09 | 18 | Ice rate | mm/h | 4 | float |
| Main | 10 | 20 | Sensor Temperature | °C / F | 4 | float |
| Main | 11 | 22 | Direction | ° | 4 | float |
| Main | 12 | 24 | Direction value | | 4 | float |
| Special | 13 | 26 | Relay A, counter | | 4 | float |

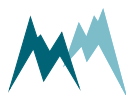

| | Index | Register address | Variable | Unit / value | Bytes | Format |
|----------|-------|------------------|---------------------|--------------|-------|--------------|
| Special | 14 | 28 | Relay A, time | h | 4 | float |
| Special | 15 | 30 | Relay B, counter | | 4 | float |
| Special | 16 | 32 | Relay B, time | h | 4 | float |
| Special | 17 | 34 | Heating current | A | 4 | float |
| Special | 18 | 36 | Supply Voltage | V | 4 | float |
| Special | 19 | 38 | Exception code | | 4 | float |
| Analysis | 20 | 40 | Measurement phase | | 4 | unsigned int |
| Analysis | 21 | 42 | Sensor 1, Ice | mm | 4 | float |
| Analysis | 22 | 44 | Sensor 1, Water | mm | 4 | float |
| Analysis | 23 | 46 | Sensor 1, Direction | | 4 | float |
| Analysis | 24 | 48 | Sensor 1, Ice raw | mm | 4 | float |
| Analysis | 25 | 50 | Sensor 1, C P1 LF | pF | 4 | float |
| Analysis | 26 | 52 | Sensor 1, C P1 HF | pF | 4 | float |
| Analysis | 27 | 54 | Sensor 1, C P2 LF | pF | 4 | float |
| Analysis | 28 | 56 | Sensor 1, C P2 HF | pF | 4 | float |
| Analysis | 29 | 58 | Sensor 1, C P3 LF | pF | 4 | float |
| Analysis | 30 | 60 | Sensor 1, C P3 HF | pF | 4 | float |
| Analysis | 31 | 62 | Sensor 1, P P1 LF | ° | 4 | float |
| Analysis | 32 | 64 | Sensor 1, P P1 HF | ° | 4 | float |
| Analysis | 33 | 66 | Sensor 1, P P2 LF | ° | 4 | float |
| Analysis | 34 | 68 | Sensor 1, P P2 HF | ° | 4 | float |
| Analysis | 35 | 70 | Sensor 1, P P3 LF | ° | 4 | float |
| Analysis | 36 | 72 | Sensor 1, P P3 HF | ° | 4 | float |

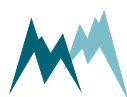

| | Index | Register address | Variable | Unit / value | Bytes | Format |
|-------------|-------|------------------|-------------------------------|--------------|-------|--------------|
| Analysis | 37 | 74 | Sensor 2, Ice | mm | 4 | float |
| Analysis | 38 | 76 | Sensor 2, Water | mm | 4 | float |
| Analysis | 39 | 78 | Sensor 2, Direction | | 4 | float |
| Analysis | 40 | 80 | Sensor 2, Ice raw | mm | 4 | float |
| Analysis | 41 | 82 | Sensor 2, C P1 LF | pF | 4 | float |
| Analysis | 42 | 84 | Sensor 2, C P1 HF | pF | 4 | float |
| Analysis | 43 | 86 | Sensor 2, C P2 LF | pF | 4 | float |
| Analysis | 44 | 88 | Sensor 2, C P2 HF | pF | 4 | float |
| Analysis | 45 | 90 | Sensor 2, C P3 LF | pF | 4 | float |
| Analysis | 46 | 92 | Sensor 2, C P3 HF | pF | 4 | float |
| Analysis | 47 | 94 | Sensor 2, P P1 LF | ° | 4 | float |
| Analysis | 48 | 96 | Sensor 2, P P1 HF | ° | 4 | float |
| Analysis | 49 | 98 | Sensor 2, P P2 LF | ° | 4 | float |
| Analysis | 50 | 100 | Sensor 2, P P2 HF | ° | 4 | float |
| Analysis | 51 | 102 | Sensor 2, P P3 LF | ° | 4 | float |
| Analysis | 52 | 104 | Sensor 2, P P3 HF | ° | 4 | float |
| Device info | - | 65533 | Device type and configuration | 320X | 2 | unsigned int |
| | - | 65534 | Software version | XYZZZ | 2 | unsigned int |
| | - | 65535 | Modbus implementation version | 10100 | 2 | unsigned int |

Table 20 Input registers



NOTE The 4-byte float values have the format *ABCD*, big-endian (*A* is the most significant byte).

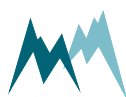

Read and write holding registers

Holding registers are mainly used to configure the Modbus adapter communication. Configuration settings are read with function 03 (read holding registers) and written with function 06 (write single registers).



NOTE Restart the Modbus adapter after changing the configuration!

| | Register address | Variable | Range | Bytes | Format |
|---------------|------------------|-----------------------------|---|-------|--------------|
| Config values | 0 | Modbus default ¹ | 0 - 1...read 1...write | 2 | unsigned int |
| | 1 | Modbus device address | 1 to 247 | | |
| | 2 | RS-485 baud rate | 1...1200 baud 2...2400 baud 3...4800 baud 4...9600 baud 5...19200 baud 6...38400 baud 7...57600 baud 8...115200 baud | | |
| | 3 | RS-485 parity/ stop bits | 1...no parity, 1 stop bit 2...no parity, 2 stop bits 3...even parity, 1 stop bit 4...odd parity, 1 stop bit | | |

Table 21 Holding registers

Report slave ID

The Modbus function 17 (report slave ID, read only) can be used to read basic information of the IDS-20a. The following example shows the response of function 17 of a RG-30 sensor, which is received in hex-format:

¹Writing "1" sets the Modbus default settings.

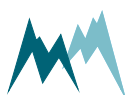



EXAMPLE 23 11 26 53 FF 27 74 20 53 6F 6D 6D 65 72 20
 20 52 47 2D 33 30 20 20 20 32 5F 37 31 72 30 31 20 34
 35 31 35 31 38 32 31 00 BB D4

| | | | Example | |
|------------------|---|----------------|-------------------------|----------------|
| | Content | Length (Bytes) | HEX-value | Decimal, ASCII |
| PDU* response | Slave address | 1 | 23 | 35 |
| | Function code | 1 | 11 | 17 |
| | Number of bytes (excl. slave-address, function code, NUL and CRC) | 1 | 26 | 38 |
| | Slave ID | 1 | 53 | "S" |
| | Run status (0=inactive; FF=active) | 1 | FF | 255 |
| | Modbus implementation version | 2 | 27 74 | 10100 |
| | Separator | 1 | 20 | " " |
| | Vendor string | 7 | 53 6F 6D 6D 65 72 20 | "Sommer " |
| | Separator | 1 | 20 | " " |
| | Device configuration | 7 | 52 47 2D 33 30 20 20 | "RG-30 " |
| | Separator | 1 | 20 | " " |
| | Software version | 7 | 32 5F 37 31 72 30 31 | 2_71r01 |
| | Separator | 1 | 20 | " " |
| | Serial number | 8 | 34 35 31 35 31 38 32 31 | 45151821 |
| | NUL | 1 | 00 | |
| | CRC | 2 | BB D4 | |

*Protocol Data Unit

Table 22 Slave ID

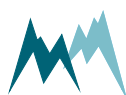

12.5.6 Reactivate Sommer protocol

Follow the instructions below to change the data output back to Sommer-protocol:

1. Open the **Connections (F8)** tab and click **New connection**.

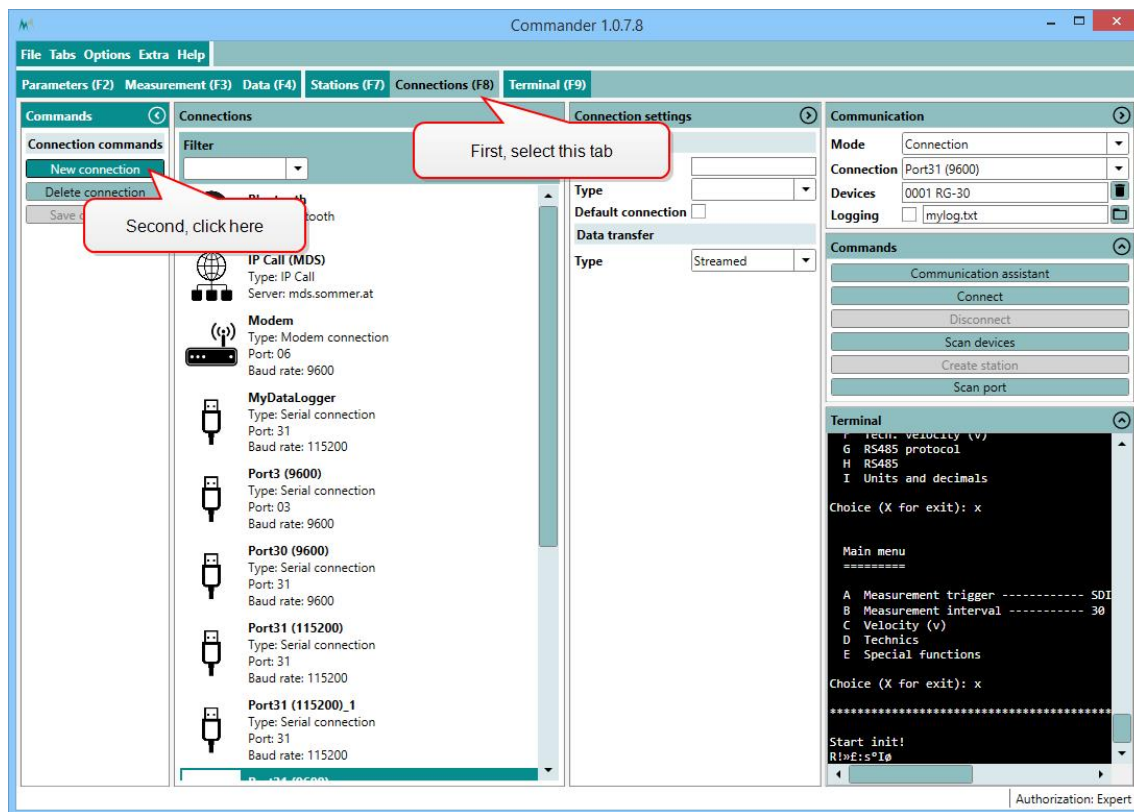

2. Enter the **Name** of the new connection. We recommend to use a meaningful name for later recognition, e.g. Modbus31 (19200) to indicate port 31 and Baud-rate 19200. Select the **Type** **Serial connection** and choose the **Port** your sensor is connected to, set the **Baud-rate** to **19200** and the **Parity/stop bits** to **Even par., 1 stop bit**.

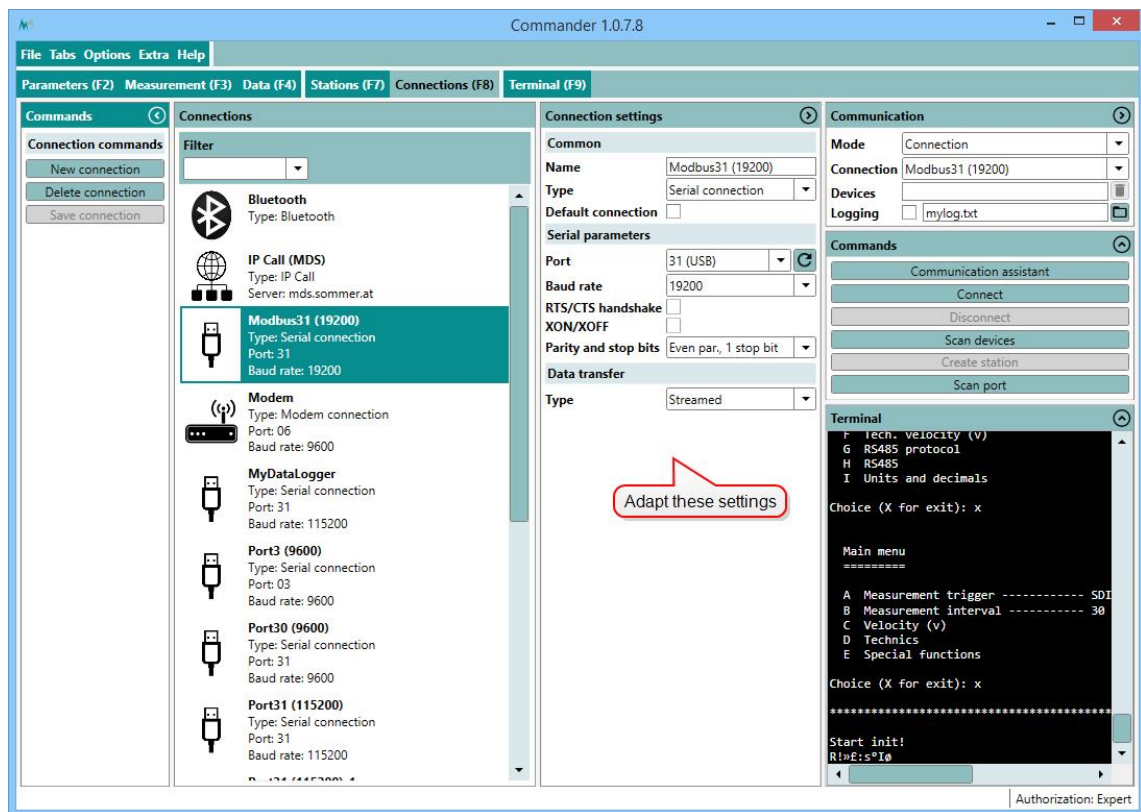

3. Click **Save connection**.
4. In the Communication window select **Mode Connection** and choose the **Connection** you have created. Then click **Connect**.

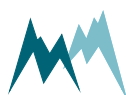

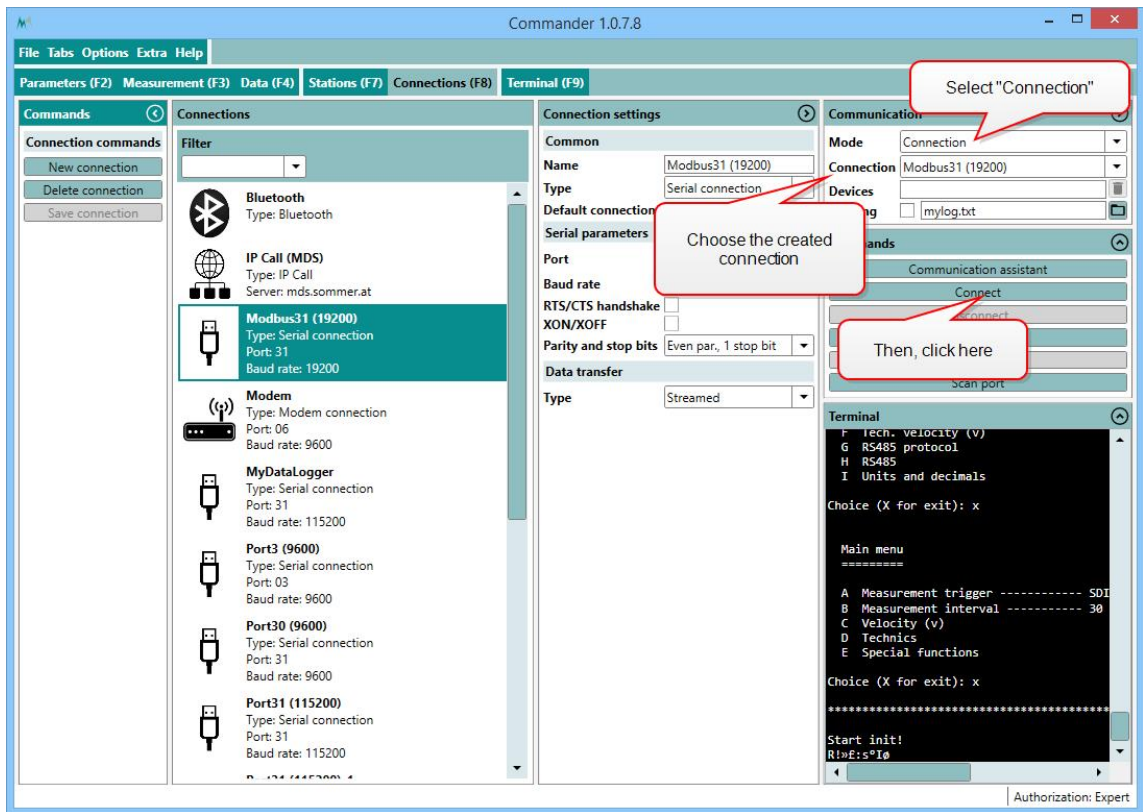

5. Download the parameters and save the parameter file as described in [Modbus configuration](#).

 **TIP** Save the parameter file for future use and to document configuration changes!

6. Now, two options are available to revert communication back to the Sommer-protocol:

- A. If a parameter file is available that has the Sommer-protocol enabled, the file can be loaded by clicking [Open parameter file](#), selecting the respective file and uploading the parameters to the device by clicking [Upload all parameters to device](#).

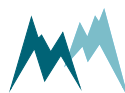

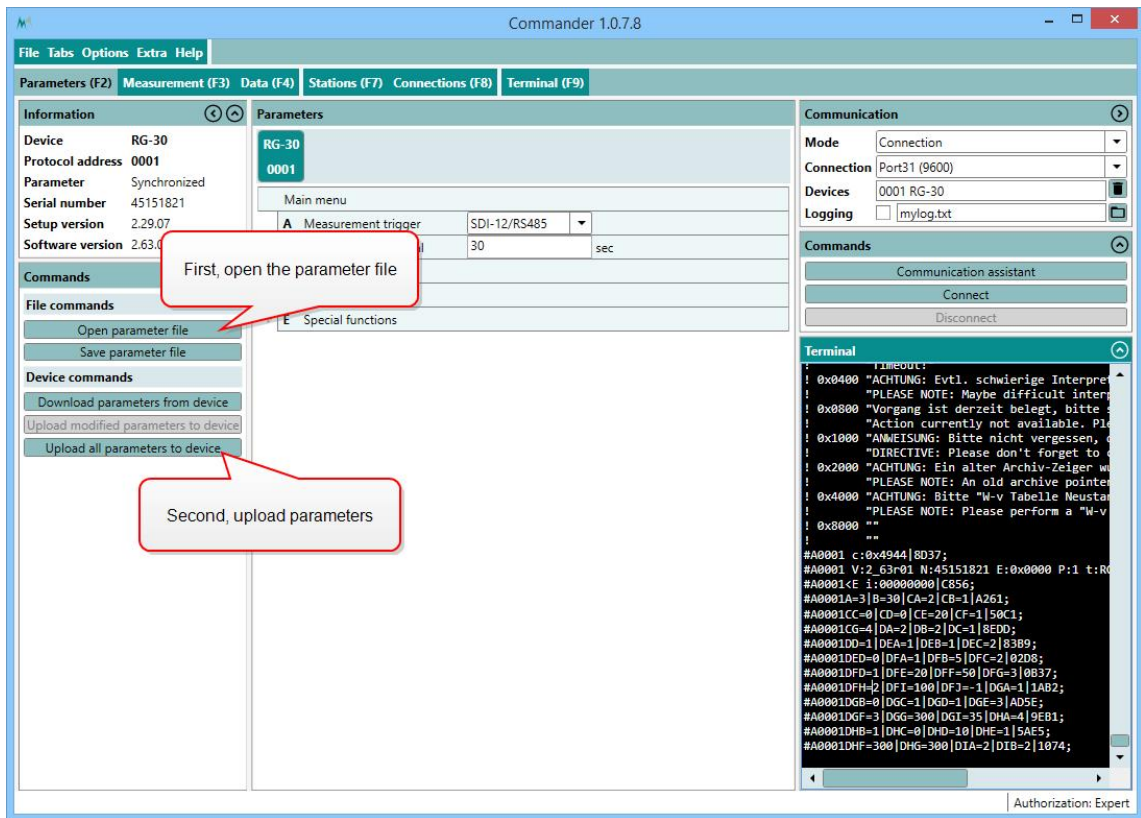

B. If no parameter file is available, the device has to be reset to its default configuration:

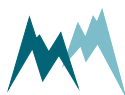

1. Click into the **Terminal** window and type `???` to enter the sensor-menu.

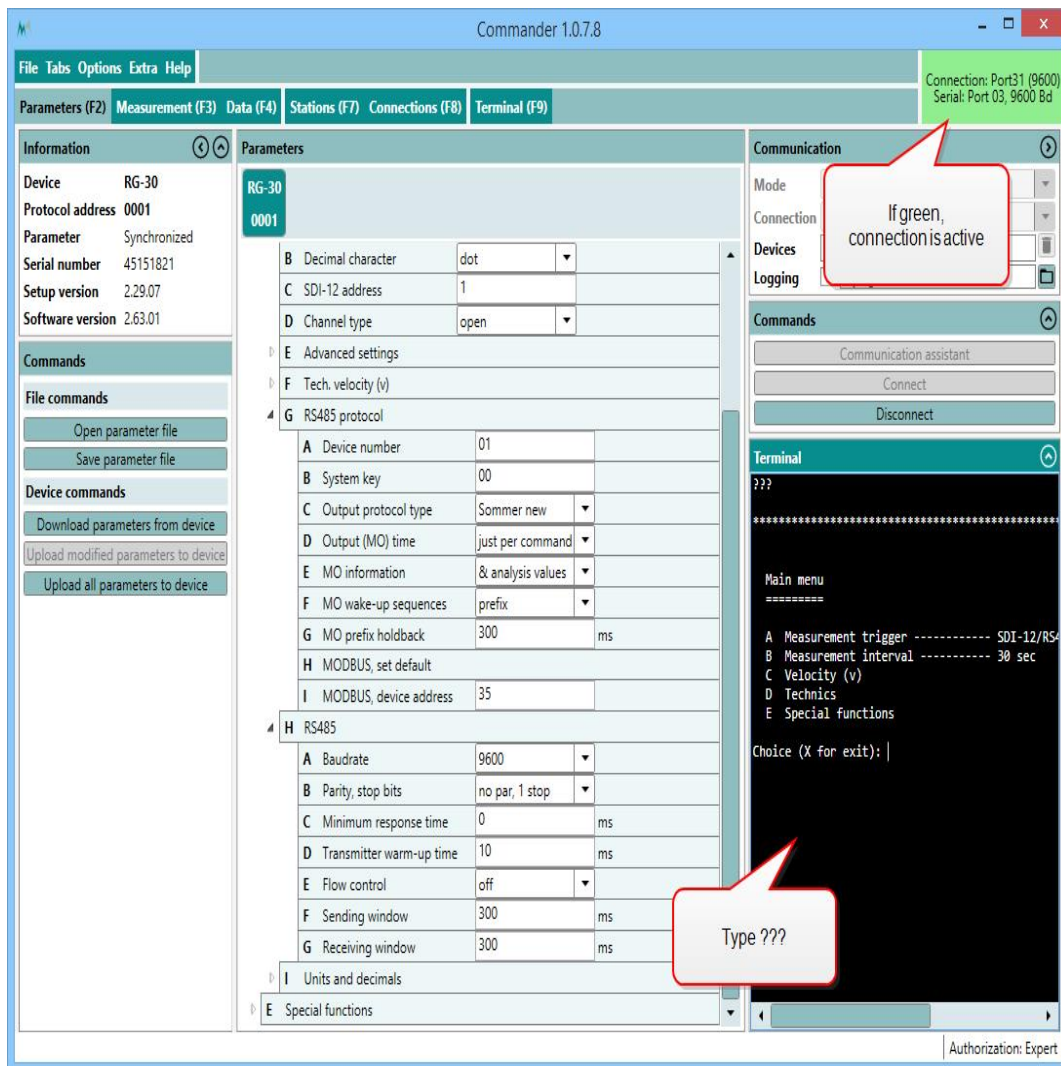

2. Navigate to **Special functions** and select **Set factory default...**
3. Acknowledge the safety-note.

```

Start up testmode: 0x07

Set factory default
AAAAAAAAAAAAAAAA

PLEASE NOTE: Please save all parameters before!
PLEASE NOTE: All user settings will be lost!
Are you sure?

(Press "RETURN" to assume)
(Press "Esc" to cancel)

=> Testmode finished!
    
```

4. Enter `X` until you get back to the main menu. The Sommer-sensor is now restarted and available in its initial configuration. As the connection-parameters have been changed to the default settings, the connection to the sensor is lost. Press **Disconnect** for



completion.

7. Establish the original connection to the Sommer-sensor as described in [Modbus configuration](#).
8. Download the sensor's parameters in the [Parameters \(F2\)](#) tab, adapt the required parameters, or upload your originally saved parameter file to the IDS-20a.

12.5.7 PLC integration

The IDS-20a can be integrated into a PLC system as a slave device. It supports the PROFIBUS, PROFINET, EtherCAT and CANopen protocols. This requires an additional serial converter, e.g. Anybus Communicator.

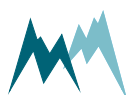

13 Parameter definitions

| | | |
|---|-------------------------|-----|
| A | Relay A | 104 |
| B | Relay B | 105 |
| C | Sensor tests | 107 |
| D | Technics | 108 |
| E | Region format | 130 |
| F | Special functions | 131 |

A Relay A

| | | |
|-----|----------------------|-----|
| A-A | Output value | 104 |
| A-B | Sensor choice | 104 |
| A-C | Turn off delay | 104 |
| A-D | Ice limit | 105 |
| A-E | Water limit | 105 |
| A-F | Ice rate limit | 105 |
| A-G | Test output | 105 |

A-A Output value

Specifies the variable which controls the relay.

| Option | Description |
|------------------|---|
| Off | Relay does not switch |
| Ice (default) | Relay is turned on if Output value exceeds specified value |
| Ice and ice rate | Relay is turned on if Output value and Output value exceed specified values |
| Water | Relay is turned on if Output value exceed specified value |

A-B Sensor choice

The sensor for which the limit value is monitored.

A-C Turn off delay

The time relay is kept energized after the monitored variable falls below the limit value again.

| Unit | sec | seconds |
|------|-----|---------|
| | | |

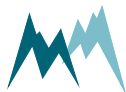

| | | |
|--------------------|-----------|---------------|
| Value range | 0...65535 | 600 (default) |
|--------------------|-----------|---------------|

A-D Ice limit

The amount of ice accreted before the relay is switched.

| | | |
|--------------------|-----------------|---------------|
| Unit | mm | |
| Value range | 0.0...9999999.9 | 0.5 (default) |

A-E Water limit

The amount of accumulated water before the relay is switched.

| | | |
|--------------------|-----------------|-----------------|
| Unit | mm | |
| Value range | 0.0...9999999.9 | 1.999 (default) |

A-F Ice rate limit

The rate at which ice accumulates before the relay is switched.

| | | |
|--------------------|--------------|---------------|
| Unit | mm/h | |
| Value range | 0...99999999 | 100 (default) |

A-G Test output

Function to test the relay manually.

B Relay B

| | | |
|-----|----------------------|-----|
| B-A | Output value | 106 |
| B-B | Sensor choice | 106 |
| B-C | Turn off delay | 106 |
| B-D | Ice limit | 106 |
| B-E | Water limit | 106 |
| B-F | Ice rate limit | 107 |
| B-G | Test output | 107 |

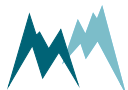

B-A Output value

Specifies the variable which controls the relay.

| Option | Description |
|------------------|---|
| Off | Relay does not switch |
| Ice (default) | Relay is turned on if Output value exceeds specified value |
| Ice and ice rate | Relay is turned on if Output value and Output value exceed specified values |
| Water | Relay is turned on if Output value exceed specified value |

B-B Sensor choice

The sensor for which the limit value is monitored.

B-C Turn off delay

The time relay is kept energized after the monitored variable falls below the limit value again.

| | | |
|--------------------|-----------|---------------|
| Unit | sec | seconds |
| Value range | 0...65535 | 600 (default) |

B-D Ice limit

The amount of ice accreted before the relay is switched.

| | | |
|--------------------|-----------------|---------------|
| Unit | mm | |
| Value range | 0.0...9999999.9 | 0.5 (default) |

B-E Water limit

The amount of accumulated water before the relay is switched.

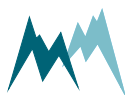

| | | |
|--------------------|-----------------|-----------------|
| Unit | mm | |
| Value range | 0.0...9999999.9 | 1.999 (default) |

B-F Ice rate limit

The rate at which ice accumulates before the relay is switched.

| | | |
|--------------------|--------------|---------------|
| Unit | mm/h | |
| Value range | 0...99999999 | 100 (default) |

B-G Test output

Function to test the relay manually.

C Sensor tests

| | | |
|-----|-------------------------------|-----|
| C-A | Sensor S1, test heating | 107 |
| C-B | Sensor S1, test | 107 |
| C-C | Sensor S2, test heating | 107 |
| C-D | Sensor S2, test | 108 |

C-A Sensor S1, test heating

Function to test the sensor heating. Heats the sensor for the selected duration.

C-B Sensor S1, test

Function to test the ice-sensor. Returns the currently measured capacity values. Used to verify that the sensor reads zero when dry.

C-C Sensor S2, test heating

Function to test the sensor heating. Heats the sensor for the selected duration.

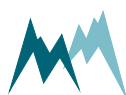

C-D Sensor S2, test

Function to test the ice-sensor. Returns the currently measured capacity values. Used to verify that the sensor reads zero when dry.

D Technics

| | | |
|-----|-------------------------------------|-----|
| D-A | SDI-12 address | 108 |
| D-B | Measurement Interval | 108 |
| D-C | Units and decimals | 108 |
| D-D | SBP device addressing | 109 |
| D-E | RS-485 (COM) | 110 |
| D-F | Sensor pair | 115 |
| D-G | Temperature and humidity (TH) | 124 |
| D-H | Advanced settings | 126 |
| D-I | Measurement table | 130 |

D-A SDI-12 address

`generic-sdi-12-address`

The address is a unique identifier of the sensor within a SDI-12 bus system.

| Value range | Default | Units |
|---------------------|---------|-------|
| 0...9, a...z, A...Z | 0 | - |

D-B Measurement Interval

`generic-measurement-interval`

The interval at which measurements are acquired.

| Value range | Default | Units |
|-------------|---------|-------|
| 20...18'000 | 60 | s |

D-C Units and decimals

| | | |
|-------|-----------------------------|-----|
| D-C-A | Temperature, unit | 109 |
| D-C-B | Temperature, decimals | 109 |

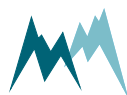

D-C-A Temperature, unit

generic-units-temperature

The following units of the air temperature can be selected:

| ID | Option | Description |
|----|--------------|-----------------|
| 1 | °C (default) | Degrees Celsius |
| 2 | °F | Fahrenheit |

D-C-B Temperature, decimals

generic-decimals-temperature

The number of decimal places for the measured air temperature.

| Value range | Default | Units |
|-------------|---------|-------|
| 0...6 | 2 | - |

D-D SBP device addressing

| | | |
|-------|---------------------|-----|
| D-D-A | Device number | 109 |
| D-D-B | System key | 109 |

D-D-A Device number

generic-rs-485-protocol-device-number

The device number is used for the unique identification of the device in a bus system.

| Value range | Default | Units |
|-------------|-------------|-------|
| 0...98 | 1 (default) | - |

D-D-B System key

generic-rs-485-protocol-system-key

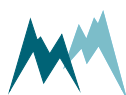

The system key defines the bus system of the device. Thus, different conceptual bus systems can be separated. Interfering bus systems occur if the remote radio coverage of two measurement systems overlap. In general, the system key should be set to 00.

| Value range | Default | Units |
|-------------|---------|-------|
| 0...99 | 0 | - |

D-E RS-485 (COM)

| | | |
|---------|--------------------------------|-----|
| D-E-A | Output protocol | 110 |
| D-E-A-A | Protocol type | 110 |
| D-E-A-B | Measurement output | 111 |
| D-E-A-C | Information | 111 |
| D-E-A-D | Wake-up sequence | 111 |
| D-E-A-E | Prefix holdback | 112 |
| D-E-A-F | MODBUS, set default | 112 |
| D-E-A-G | MODBUS, device address | 112 |
| D-E-B | Port | 113 |
| D-E-B-A | Baud rate | 113 |
| D-E-B-B | Parity, stop bits | 113 |
| D-E-B-C | Minimum response time | 114 |
| D-E-B-D | Transmitter warm-up time | 114 |
| D-E-B-E | Flow control | 114 |
| D-E-B-F | Sending window | 114 |
| D-E-B-G | Receiving window | 115 |

D-E-A Output protocol

| | | |
|---------|------------------------------|-----|
| D-E-A-A | Protocol type | 110 |
| D-E-A-B | Measurement output | 111 |
| D-E-A-C | Information | 111 |
| D-E-A-D | Wake-up sequence | 111 |
| D-E-A-E | Prefix holdback | 112 |
| D-E-A-F | MODBUS, set default | 112 |
| D-E-A-G | MODBUS, device address | 112 |

D-E-A-A Protocol type

`generic-rs-485-protocol-type`

The type of the serial output protocol. The following options are available:

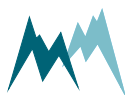

| ID | Option | Description |
|----|------------------|--|
| 1 | Sommer (default) | Sommer bus protocol (SBP); data values are returned with an index starting at 1. Multiple strings may be returned. |
| 2 | Standard | Standard protocol; data values are returned without an index in one string. |
| 3 | MODBUS | Modbus protocol |



NOTE For MODBUS applications run `MODBUS, set default` to get the appropriate communication settings.

D-E-A-B Measurement output

`generic-rs-485-protocol-measurement-output`

Specifies the timing of the serial data output.

| ID | Option | Description |
|----|-----------------------------|--|
| 1 | Just per command | The output is only requested by commands via RS-485. |
| 2 | After measurement (default) | The serial data output is performed automatically right after each measurement. |
| 3 | Pos. TRIG slope | The output is triggered by a positive edge of a control signal applied to the trigger input. |

D-E-A-C Information

`generic-rs-485-protocol-information`

The main measurement values are always included in the data output string. Additionally, special and analysis values can be included.

| ID | Option | Description |
|----|----------------------------|---|
| 1 | Main values | Only the main values are returned. |
| 2 | & Special values (default) | Main values and special values are returned. |
| 3 | & Analysis values | Main, special and analysis values are returned. |

D-E-A-D Wake-up sequence

`generic-rs-485-protocol-wake-up-sequence`

Serial data can be transmitted to a recording device automatically without a request. However, many devices demand a wake-up sequence before they can receive and process data. The IDS-20a has the

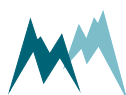

option to send a sync sequence and a prefix before data are transmitted. The following options are available:

| ID | Option | Description |
|----|------------------|--|
| 1 | Off | No wake-up sequence |
| 2 | Sync | The sync sequence UU~?~? is sent before the output string. |
| 3 | Prefix (default) | A blank with a time delay is sent before the output string. |
| 4 | Prefix & Sync | A blank with a time delay and the sync sequence UU~?~? is sent before the output string. |

D-E-A-E Prefix holdback

`generic-rs-485-protocol-prefix-holdback`

The hold-back time defines the time delay between the prefix and the data string.

| Value range | Default | Units |
|-------------|---------|-------|
| 0...5'000 | 300 | ms |

D-E-A-F MODBUS, set default

`generic-rs-485-protocol-modbus-set-default`

Sets all parameters required for Modbus communication automatically. The following settings are adapted:

| Parameter | Modbus setting |
|--------------------------|------------------|
| OP, measurement output | just per command |
| Output protocol (OP) | Modbus |
| MODBUS, device address | 35 |
| Sleep mode | Modbus, slow |
| Parity, stop bits | even par, 1 stop |
| Baud rate | 19200 |
| Flow control | off |
| Transmitter warm-up time | 10 ms |
| Minimum response time | 30 ms |

D-E-A-G MODBUS, device address

`generic-rs-485-protocol-modbus-device-address`

Unique device address for the Modbus protocol.

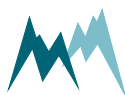

| Value range | Default | Units |
|-------------|---------|-------|
| 1...247 | 35 | - |

D-E-B Port

| | | |
|---------|--------------------------------|-----|
| D-E-B-A | Baud rate | 113 |
| D-E-B-B | Parity, stop bits | 113 |
| D-E-B-C | Minimum response time | 114 |
| D-E-B-D | Transmitter warm-up time | 114 |
| D-E-B-E | Flow control | 114 |
| D-E-B-F | Sending window | 114 |
| D-E-B-G | Receiving window | 115 |

D-E-B-A Baud rate

`generic-rs-485-port-baud-rate`

The following transmission rates in bps (baud) can be selected:

| ID | Option | Description |
|----|--|-------------|
| 1 | 1'200 | - |
| 2 | 2'400 | - |
| 3 | 4'800 | - |
| 4 | 9'600 (default for sensors and data logger inputs) | - |
| 5 | 19'200 (default if used with radio communication) | - |
| 6 | 38'400 | - |
| 7 | 57'600 | - |
| 8 | 115'200 (default for data loggers) | - |

D-E-B-B Parity, stop bits

`generic-rs-485-port-parity-stop-bits`

The following combinations of parity and stop bits can be selected:

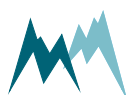

| ID | Option | Description |
|----|--------------------------|----------------------------|
| 1 | No par, 1 stop (default) | No parity and 1 stop bit |
| 2 | No par, 2 stop | No parity and 2 stop bits |
| 3 | Even par, 1 stop | Even parity and 1 stop bit |
| 4 | Odd par, 1 stop | Odd parity and 1 stop bit |

D-E-B-C Minimum response time

`generic-rs-485-port-minimum-response-time`

This setting avoids failures of half-duplex interfaces. For this purpose the response to a command is delayed by the selected time. Additionally, the response is also kept temporally compact.

| Value range | Default | Units |
|-------------|---------|-------|
| 0...2'000 | 10 | ms |

D-E-B-D Transmitter warm-up time

`generic-rs-485-port-transmitter-warm-up-time`

The transmitter warm-up time defines the time before data is sent.

| Value range | Default | Units |
|-------------|---------|-------|
| 0...2'000 | 10 | ms |

D-E-B-E Flow control

`generic-rs-485-port-flow-control`

Flow control for the defined application.

| ID | Option | Description |
|----|-----------------------------|---|
| 1 | Off | no flow control |
| 2 | XOFF-XON blocking (default) | XOFF-XON flow control, especially adapted for half-duplex systems |
| 4 | DFM-RC | Flowcontrol for Sommer Messtechnik DFM point-to-point radios. |
| 5 | DFM-TM | Flowcontrol for Sommer Messtechnik DFM tiny-mesh radios. |

D-E-B-F Sending window

`generic-rs-485-port-sending-window`

If XON-XOFF flow control is activated data are transmitted in blocks with the defined length.

| Value range | Default | Units |
|-------------|---------|-------|
| 200...5'000 | 300 | ms |

D-E-B-G Receiving window

`generic-rs-485-port-receiving-window`

If XON-XOFF flow control is activated transmission of blocks is delayed by the specified time.

| Value range | Default | Units |
|-------------|---------|-------|
| 200...5'000 | 300 | ms |

D-F Sensor pair

| | | |
|-------|------------------------------|-----|
| D-F-A | Sensor type | 115 |
| D-F-B | Sensor early heating | 116 |
| D-F-C | Icing verification | 116 |
| D-F-D | Limits and timer | 117 |
| D-F-E | Sensor S1, orientation | 122 |
| D-F-F | Sensor S1 temperature | 123 |
| D-F-G | Sensor S1, zero adjust | 123 |
| D-F-H | Sensor S1, test | 123 |
| D-F-I | Sensor S2, orientation | 123 |
| D-F-J | Sensor S2 temperature | 124 |
| D-F-K | Sensor S2, zero adjust | 124 |
| D-F-L | Sensor S2, test | 124 |

D-F-A Sensor type

One of the following sensor types can be selected:

| Option | Description |
|------------------|---|
| Cube 5 (default) | Cube 5 sensor |
| Rod T 80 | Rod sensor 80 |
| Custom | Reserved for custom or new sensor types |

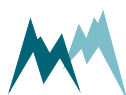

D-F-B Sensor early heating

If this setting is on and the ice-layer thickness measured by the active sensor is exceeded by the measurement of the passive (previously heated) sensor before the [Ice, swop active sensor](#) limit is reached, the status of the sensors is swapped, i.e. the passive sensor gets the active sensor and the previously active sensor enters a heating cycle. This situation can often be observed towards the end of an icing event.

D-F-C Icing verification

| | | |
|---------|---------------------------------|-----|
| D-F-C-A | Maximum temperature | 116 |
| D-F-C-B | Minimum humidity | 116 |
| D-F-C-C | Maximum water | 116 |
| D-F-C-D | Switch on delay | 117 |
| D-F-C-E | Temperature sensor choice | 117 |

D-F-C-A Maximum temperature

Temperature below which icing may occur.

| | | |
|--------------------|---------------------|---------------|
| Unit | °C | |
| Value range | -99999.9...999999.9 | 0.5 (default) |

D-F-C-B Minimum humidity

Relative humidity above which icing may occur.

| | | |
|--------------------|-----------------|--------------|
| Unit | - | |
| Value range | 0.0...9999999.9 | 80 (default) |

D-F-C-C Maximum water

Thickness of water layer below which icing may occur.

| | | |
|--------------------|-----------------|---------------|
| Unit | mm | |
| Value range | 0.0...9999999.9 | 0.5 (default) |

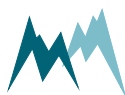

D-F-C-D Switch on delay

Time delay between verification of icing and actual output of icing in data string. Specifying a delay might be advisable under threshold conditions.

| | | |
|--------------------|----------|-------------|
| Unit | sec | |
| Value range | 0...7200 | 0 (default) |

D-F-C-E Temperature sensor choice

The temperature sensor used for icing verification. Select one of the following options:

| Option | Description |
|------------------------------|---|
| sensor temperature (default) | The surface temperature of the IDS-20a sensor |
| air temperature | The air temperature of the external T/rH-sensor |

D-F-D Limits and timer

| | | |
|---------|-------------------------------|-----|
| D-F-D-A | Min. sup. voltage for heating | 117 |
| D-F-D-B | Ice, maximum | 118 |
| D-F-D-C | Ice, minimum | 118 |
| D-F-D-D | Ice, swop active sensor | 118 |
| D-F-D-E | Accumulation maximum | 118 |
| D-F-D-F | Water, maximum | 118 |
| D-F-D-G | Water, minimum | 119 |
| D-F-D-H | Ice rate, heating | 119 |
| D-F-D-I | Ice rate, minimum | 120 |
| D-F-D-J | Ice rate, holdtime | 120 |
| D-F-D-K | Maximum heating time | 121 |
| D-F-D-L | Subsequent heating, head | 121 |
| D-F-D-M | Subsequent heating, shaft | 121 |
| D-F-D-N | Cool down duration | 121 |
| D-F-D-O | Duration frost suppression | 121 |
| D-F-D-P | Meas. duration icing rate | 122 |

D-F-D-A Min. sup. voltage for heating

Minimum supply voltage for sensor heating.

| | | |
|--------------------|------------------|--------------|
| Unit | V | |
| Value range | 0.00...999999.99 | 10 (default) |



D-F-D-B Ice, maximum

Maximum ice accumulation before sensor starts heating.

| | | |
|--------------------|---------------|-------------|
| Unit | mm | |
| Value range | 0...9999999.9 | 1 (default) |

D-F-D-C Ice, minimum

Thickness of ice layer at which heating stops. This limit is only active in combination with [Water, minimum](#).

| | | |
|--------------------|---------------|---------------|
| Unit | mm | |
| Value range | 0...9999999.9 | 0.1 (default) |

D-F-D-D Ice, swop active sensor

During continuous operation one of the sensors is the active sensor and monitors icing while the other, the passive sensor, is heated and dried. As soon as the passive sensor is dry it starts measuring ice accretion again. Once the ice layer on the passive sensor has reached the ice exchange clearance limit the passive sensor becomes the active sensor and the previously active sensor enters a heating cycle. See [Figure 6](#) for an illustration of the heating cycles.

| | | |
|--------------------|-----------------|----------------|
| Unit | mm | |
| Value range | 0.0...9999999.9 | 0.15 (default) |

D-F-D-E Accumulation maximum

The ice accumulation measured by each sensor is summed up and returned by the IDS-20a as the current ice layer thickness (index 07 of the main values). If this thickness has reached the value of accumulation end the current ice layer thickness is reset to zero. Setting this limit avoids data overflow.

| | | |
|--------------------|------------------|--------------|
| Unit | mm | |
| Value range | 0.00...999999.99 | 10 (default) |

D-F-D-F Water, maximum

Maximum water accumulation before sensor starts heating.

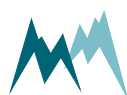

| | | |
|--------------------|-----------------|-------------|
| Unit | mm | |
| Value range | 1.0...9999999.9 | 2 (default) |

D-F-D-G Water, minimum

Thickness of water layer at which heating stops. This limit is only active in combination with [Ice, minimum](#).

| | | |
|--------------------|-----------------|---------------|
| Unit | mm | |
| Value range | 0.0...9999999.9 | 0.1 (default) |

D-F-D-H Ice rate, heating

A switch to activate a sensor heating if the icing-rate drops below a specified limit. Generally, this option is used to detect individual icing-events.

If ice accumulates on the sensor above a limit value specified in [Ice limit](#), relay A and/or B close; see [Figure 9](#) for an illustration. Ice accretion may continue above this limit value, but may eventually cease, i.e. the icing rate levels off. Any further accumulation on the existing ice layer can be detected with reduced sensitivity only. Thus, it would be advantageous to continue ice-monitoring with a dry sensor surface. The “ice rate, heating” setting enables this option: If the icing rate falls below the value specified in [Ice rate, minimum](#) over the time set in [Ice rate, holdtime](#) a sensor heating is triggered. Consequently, relay A and/or B open, the sensor is defrosted and the IDS-20a is ready to detect a new icing event.

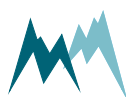

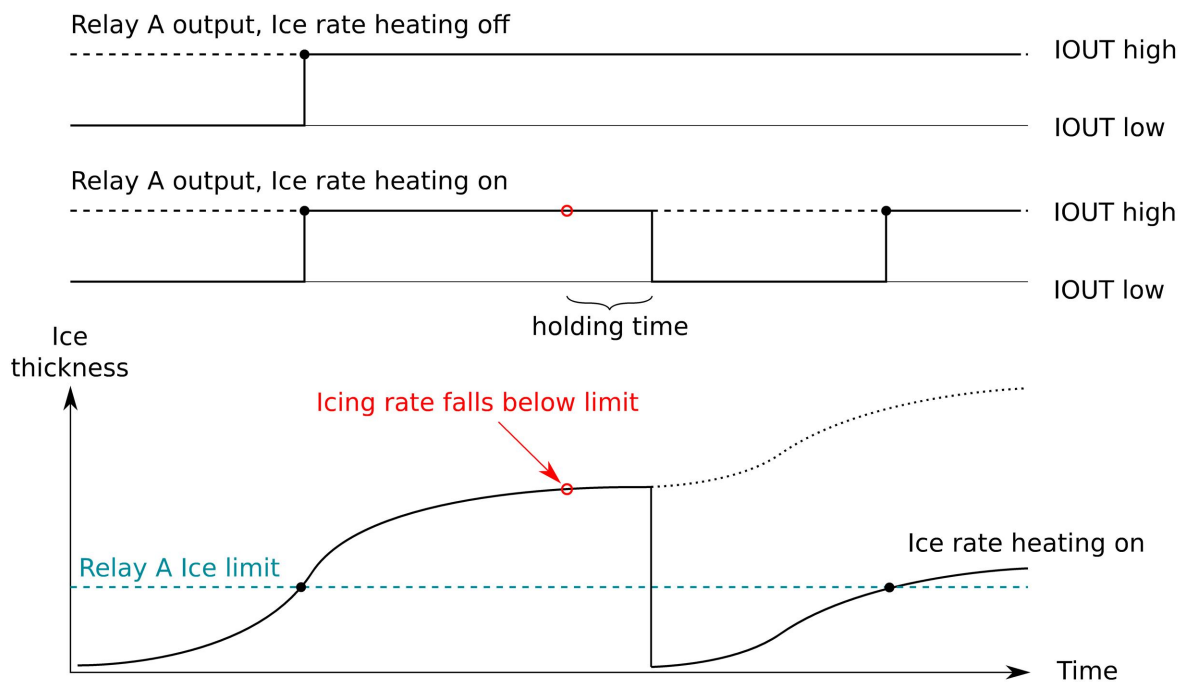

Figure 9 Behavior of Ice rate heating option

| Option | Description |
|--------------|---|
| off | Sensor heating triggered by reduced icing rate is inactive. |
| on (default) | Sensor heating triggered by reduced icing rate active. |

D-F-D-I Ice rate, minimum

Minimum icing rate below which a sensor heating is triggered. See [Ice rate, heating](#) for details.

| | | |
|--------------------|-----------------------|---------------|
| Unit | mm/h | |
| Value range | -999999.9...9999999.9 | 0.5 (default) |

D-F-D-J Ice rate, holdtime

Time before a sensor heating is triggered due to a low icing rate. See [Ice rate, heating](#) for details.

| | | |
|--------------------|----------|---------------|
| Unit | sec | |
| Value range | 0...7200 | 600 (default) |

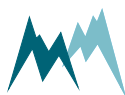

D-F-D-K Maximum heating time

Maximum heating duration for one heating cycle.

| | | |
|--------------------|----------|---------------|
| Unit | sec | |
| Value range | 0...7200 | 600 (default) |

D-F-D-L Subsequent heating, head

The time the sensor head is continued to be heated after a regular heating cycle.

| | | |
|--------------------|----------|-------------|
| Unit | sec | |
| Value range | 0...1800 | 0 (default) |

D-F-D-M Subsequent heating, shaft

The time the sensor shaft is continued to be heated after a regular heating cycle.

| | | |
|--------------------|----------|---------------|
| Unit | sec | |
| Value range | 0...1800 | 120 (default) |

D-F-D-N Cool down duration

Time for sensor to cool down to ambient conditions.

| | | |
|--------------------|----------|---------------|
| Unit | sec | |
| Value range | 0...1800 | 180 (default) |

D-F-D-O Duration frost suppression

Frost generally builds up to thin ice layers well below the [Ice, minimum](#) limit and the relay [Duration frost suppression](#) before accretion levels off. To detect individual frost events a sensor heating can be triggered after a specified time with no further ice accumulation. The sensor surface is then dry again to sense the next frost-event. [Figure 10](#) illustrates such a situation:

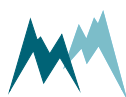

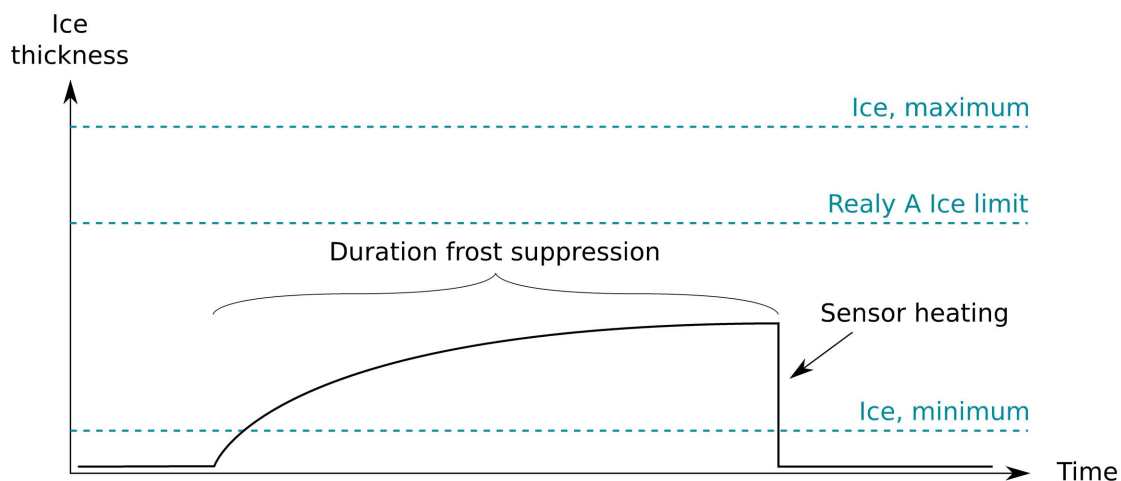

Figure 10 Duration frost suppression



ATTENTION If **Duration frost suppression** is set to **0** frost suppression is inactive.

| | | |
|--------------------|----------------|-------------|
| Unit | sec | |
| Value range | -86400...86400 | 0 (default) |

D-F-D-P Meas. duration icing rate

Measurement time used to determine icing rate.

| | | |
|--------------------|----------|---------------|
| Unit | sec | |
| Value range | 0...1800 | 360 (default) |

D-F-E Sensor S1, orientation

The orientation of the sensor relative to geographic north. Use the black mark on the cube sensor for northing.

| | | |
|--------------------|------------|-------------|
| Unit | ° | |
| Value range | -180...359 | 0 (default) |

D-F-F Sensor S1 temperature

| | | |
|---------|--------------------------|-----|
| D-F-F-A | Temperature offset | 123 |
| D-F-F-B | Adjust temperature | 123 |
| D-F-F-C | Test temperature | 123 |

D-F-F-A Temperature offset

Offset of the temperature of the T/rH-sensor. An offset might be required if the sensor needs to be matched to an external reference.

| | | |
|--------------------|---------------------|-------------|
| Unit | °C | |
| Value range | -9999.99...99999.99 | 0 (default) |

D-F-F-B Adjust temperature

Function to adjust the temperature measurement of the T/rH-sensor. Applying this function will update the setting [Temperature offset](#).

D-F-F-C Test temperature

Function to test the temperature measurement of the T/rH-sensor.

D-F-G Sensor S1, zero adjust

Function to reset the capacity measurements of the sensor plates. Only used during installation to compensate for any capacities introduced by the sensor cable.

D-F-H Sensor S1, test

Function to test the ice-sensor. Returns the currently measured capacity values. Used to verify that the sensor reads zero when dry.

D-F-I Sensor S2, orientation

The orientation of the sensor relative to geographic north. Use the black mark on the cube sensor for nothing.

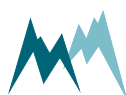

| | | |
|--------------------|------------|-------------|
| Unit | ° | |
| Value range | -180...359 | 0 (default) |

D-F-J Sensor S2 temperature

| | | |
|---------|--------------------------|-----|
| D-F-J-A | Temperature offset | 124 |
| D-F-J-B | Adjust temperature | 124 |
| D-F-J-C | Test temperature | 124 |

D-F-J-A Temperature offset

Offset of the temperature of the T/rH-sensor. An offset might be required if the sensor needs to be matched to an external reference.

| | | |
|--------------------|---------------------|-------------|
| Unit | °C | |
| Value range | -9999.99...99999.99 | 0 (default) |

D-F-J-B Adjust temperature

Function to adjust the temperature measurement of the T/rH-sensor. Applying this function will update the setting [Temperature offset](#).

D-F-J-C Test temperature

Function to test the temperature measurement of the T/rH-sensor.

D-F-K Sensor S2, zero adjust

Function to reset the capacity measurements of the sensor plates. Only used during installation to compensate for any capacities introduced by the sensor cable.

D-F-L Sensor S2, test

Function to test the ice-sensor. Returns the currently measured capacity values. Used to verify that the sensor reads zero when dry.

D-G Temperature and humidity (TH)

| | | |
|-------|-----------------------|-----|
| D-G-A | Humidity offset | 125 |
|-------|-----------------------|-----|

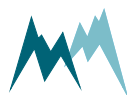

| | | |
|-------|--------------------------|-----|
| D-G-B | Adjust humidity | 125 |
| D-G-C | Test humidity | 125 |
| D-G-D | Temperature offset | 125 |
| D-G-E | Adjust temperature | 125 |
| D-G-F | Test temperature | 126 |

D-G-A Humidity offset

Offset of the humidity of the T/rH-sensor. An offset might be required if the sensor needs to be matched to an external reference.

| | | |
|--------------------|-----------------------|---------------|
| Unit | °C | |
| Value range | -999999.9...9999999.9 | 0.0 (default) |

D-G-B Adjust humidity

Function to adjust the humidity measurement of the T/rH-sensor. Applying this function will update the setting [Humidity offset](#).

D-G-C Test humidity

Function to test the humidity measurement of the T/rH-sensor.

D-G-D Temperature offset

Offset of the temperature of the T/rH-sensor. An offset might be required if the sensor needs to be matched to an external reference.

| | | |
|--------------------|---------------------|-------------|
| Unit | °C | |
| Value range | -9999.99...99999.99 | 0 (default) |

D-G-E Adjust temperature

Function to adjust the temperature measurement of the T/rH-sensor. Applying this function will update the setting [Temperature offset](#).



D-G-F Test temperature

Function to test the temperature measurement of the T/rH-sensor.

D-H Advanced settings

| | | |
|-------|------------------------------------|-----|
| D-H-A | Sleep mode | 126 |
| D-H-B | SDI12 'M'-response | 126 |
| D-H-C | "OFF" turn off temperature | 127 |
| D-H-D | Functional switch monitoring | 128 |
| D-H-E | Functional switch at "OFF" | 128 |
| D-H-F | Sommer ID | 129 |

D-H-A Sleep mode

`generic-sleep-mode`

Defines the behavior of the IDS-20a between two measurements, provided the measurement interval is longer than the time of the measurement itself. The following options are available:

| ID | Option | Description |
|----|--------------------|--|
| 1 | MODBUS, fast | For MODBUS applications. The IDS-20a stays in normal mode. This option permits high data transmission rates, but increases power consumption. |
| 2 | MODBUS, slow | For MODBUS applications. The IDS-20a goes into idle mode and can be woken up by a command via the RS-485 interface with a low baud rate. This option reduces power consumption at lower data transmission rates. |
| 3 | Standard (default) | The IDS-20a goes into sleep mode and can be woken up by a command via the RS-485 interface only with a time delay. Option with the lowest power consumption. |

D-H-B SDI12 'M'-response

`generic-sdi-12-m-response`

Defines how an SDI-12 M-command received by the IDS-20a is answered if the requested number of measurement values exceeds 9. The following options are available:

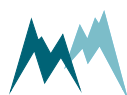

| ID | Parameter | Description |
|----|----------------------------|---|
| 1 | expand address | This option should only be used with SDI-12 standard V1.0. The measurement values can be requested with the commands <code>aD0!</code> , <code>aD1!</code> , ..., with <code>a</code> the sensor address. Max. 9 values are returned for each command. |
| 2 | just expand output | The <code>M</code> -request received by the IDS-20a is answered according to SDI-12 standard V1.3, which supports transmitting more than 9 measurement values per answer. |
| 3 | as at 'C' request | The <code>M</code> -request received by the IDS-20a is answered as if several <code>C</code> -requests were sent. |
| 4 | M1, M2, M3 split (default) | The <code>M</code> -request received by the IDS-20a is answered as if several <code>M_k</code> -commands were sent, with <code>k</code> depending on the number of measurement values to be transmitted (<code>M1</code> returns the first 9 measurement values, <code>M2</code> the second nine values, etc). |

D-H-C “OFF” turn off temperature

The ambient temperature above which the IDS-20a stops performing measurements.

| | | |
|--------------------|---------------------|--------------|
| Unit | °C | |
| Value range | -99999.9...999999.9 | 10 (default) |



NOTE

If the ambient temperature exceeds “OFF” turn off temperature, the IDS-20a returns the following values for ice and water variables:

| Protocol | Returned value |
|----------|--------------------------|
| RS-485 | empty string |
| SDI-12 | 00000000 |
| Modbus | 10^6 , 10^7 , 10^8 |

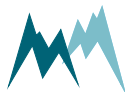

D-H-D Functional switch monitoring

Sets the activity of the “OUT function” output. The following options are available:

| Option | Description |
|----------------------------|--|
| just while awake | The “OUT function” output is only active while the device is active. |
| always active (default) | The “OUT function” output is always active. |



ATTENTION If **Functional switch monitoring** is set to *just while awake*, **Sleep mode** must be set to *standard*!

D-H-E Functional switch at “OFF”

The status of the “OUT Function” relay of the IDS-20a. This status depends on the instrument status and the “OFF” **turn off temperature** (above this temperature the IDS-20a does not perform icing-measurements). The OUT Function output is an "active high" output, i.e. as long as the instruments operates normally, the output is high. The following options are available:

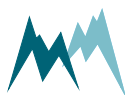

| Option | Description | | | | | | | | | | | | | | | |
|-----------------------------|---|-------------------|---------------------|---------------------|----|----|---|----|-----|---|-------|----|---|-------|-----|---|
| regular condition (default) | If the ambient temperature is above the limit value the output is set to high (1) and the relay is closed. | | | | | | | | | | | | | | | |
| | <table border="1"> <thead> <tr> <th>Instrument status</th> <th>T above limit</th> <th>OUT Function status</th> </tr> </thead> <tbody> <tr> <td>OK</td> <td>No</td> <td>1</td> </tr> <tr> <td>OK</td> <td>Yes</td> <td>1</td> </tr> <tr> <td>Error</td> <td>No</td> <td>0</td> </tr> <tr> <td>Error</td> <td>Yes</td> <td>0</td> </tr> </tbody> </table> | Instrument status | T above limit | OUT Function status | OK | No | 1 | OK | Yes | 1 | Error | No | 0 | Error | Yes | 0 |
| | Instrument status | T above limit | OUT Function status | | | | | | | | | | | | | |
| | OK | No | 1 | | | | | | | | | | | | | |
| | OK | Yes | 1 | | | | | | | | | | | | | |
| Error | No | 0 | | | | | | | | | | | | | | |
| Error | Yes | 0 | | | | | | | | | | | | | | |
| OK | No | 1 | | | | | | | | | | | | | | |
| OK | Yes | 1 | | | | | | | | | | | | | | |
| Error | No | 0 | | | | | | | | | | | | | | |
| Error | Yes | 0 | | | | | | | | | | | | | | |
| error condition | If the ambient temperature is above the limit value the output is set to low (0) and the relay is opened. Thus, ambient temperatures that are too high are handled like any other error (output is set to low [0]). If the ambient temperature is below the limit value and the instrument operates normally the output is set to high (1). | | | | | | | | | | | | | | | |
| | <table border="1"> <thead> <tr> <th>Instrument status</th> <th>T above limit</th> <th>OUT Function status</th> </tr> </thead> <tbody> <tr> <td>OK</td> <td>No</td> <td>1</td> </tr> <tr> <td>OK</td> <td>Yes</td> <td>0</td> </tr> <tr> <td>Error</td> <td>No</td> <td>0</td> </tr> <tr> <td>Error</td> <td>Yes</td> <td>0</td> </tr> </tbody> </table> | Instrument status | T above limit | OUT Function status | OK | No | 1 | OK | Yes | 0 | Error | No | 0 | Error | Yes | 0 |
| | Instrument status | T above limit | OUT Function status | | | | | | | | | | | | | |
| | OK | No | 1 | | | | | | | | | | | | | |
| | OK | Yes | 0 | | | | | | | | | | | | | |
| Error | No | 0 | | | | | | | | | | | | | | |
| Error | Yes | 0 | | | | | | | | | | | | | | |
| OK | No | 1 | | | | | | | | | | | | | | |
| OK | Yes | 0 | | | | | | | | | | | | | | |
| Error | No | 0 | | | | | | | | | | | | | | |
| Error | Yes | 0 | | | | | | | | | | | | | | |

An instrument error occurs if the power supply of the instrument is insufficient, the software detects a fatal error, a software procedure is slow or blocked or if the software runs in the bootloader.

D-H-F Sommer ID

```
generic-sommer-id
```

The Sommer ID is used to define stations within the Commander software. The ID is preset in the device and corresponds to its serial number. SOMMER suggests not to change the ID, except if a IDS-20a device is replaced. In such a case it can be practical to change the ID of the new device to the ID of the replaced device to guarantee data consistency.

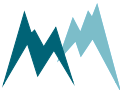

D-I Measurement table

Lists all measured variables with their units (see [Data output](#)).

| Index | Value | Unit | Description |
|-------|--------------------|--------|---|
| 01 | Temperature | °C / F | Air temperature |
| 02 | Humidity | % | Humidity |
| 03 | Dew point | °C / F | Dew point |
| 04 | Relay A | 0 / 1 | State of relay A |
| 05 | Relay B | 0 / 1 | State of relay B |
| 06 | Relay function | 0 / 1 | State of measurement device |
| 07 | Ice | mm | Current ice layer thickness |
| 08 | Water | mm | Current water layer thickness |
| 09 | Ice rate | mm/h | Current icing rate on |
| 10 | Sensor Temperature | °C / F | Surface temperature |
| 11 | Direction | ° | Icing direction |
| 12 | Direction value | | Directional distinction of ice accretion; the higher the value the more pronounced icing is in a certain direction. |

E Region format

| | | |
|-----|-------------------------|-----|
| E-A | Language/Sprache | 130 |
| E-B | Decimal character | 131 |

E-A Language/Sprache

`generic-language`

The menu language.

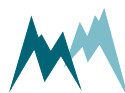

| ID | Option | Description |
|----|----------------------------|------------------|
| 1 | German/Deutsch | German language |
| 2 | English/Englisch (default) | English language |

E-B Decimal character

`generic-decimals-character`

The character used as decimal separator in the values of the settings, in serial data strings and in .csv files.

| ID | Option | Description |
|----|---------------|-------------|
| 1 | Comma | - |
| 2 | Dot (default) | - |

F Special functions

| | | |
|-----|----------------------------------|-----|
| F-A | Relay, reset counters | 131 |
| F-B | Relay, simulate outputs | 131 |
| F-C | Device status | 132 |
| F-D | View setup | 132 |
| F-E | Set factory default | 132 |
| F-F | Temp. load factory default | 132 |
| F-G | Relaunch program | 132 |

F-A Relay, reset counters

Resets the relay counters.

F-B Relay, simulate outputs

Only available in terminal mode. This function is primarily used for remote system testing and can be triggered by the test input on pin 5 (see for details). It offers two options:

1. If option **1** is selected or the trigger signal on pin 5 is set high the following tasks are performed in sequence:

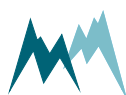

- a. Relay A is closed and the sensor heating (head and shaft) is turned on for 60 sec (if sensor 1 is active)
 - b. Relay B is closed and the sensor heating (head and shaft) is turned on for 60 sec (if sensor 2 is active)
2. If option 2 is selected or the trigger signal on pin 5 is set high for more than 10 sec the tasks in option 1 are performed and the relay counters are reset.

F-C Device status

`generic-special-functions-device-status`

Displays information about the device and the software version.

F-D View setup

`generic-special-functions-view-setup`

All parameters of the IDS-20a are listed in the terminal window.

F-E Set factory default

`generic-special-functions-set-factory-default`

All parameters are reset to factory defaults. Only available in terminal-mode.

F-F Temp. load factory default

`generic-special-functions-temp-load-factory-default`

Loads factory default values temporarily. Only available in terminal mode.

F-G Relaunch program

`generic-special-functions-relaunch-program`

The device is restarted. Powering the sensor off and on again is equivalent.



Appendix A Measurement phases

The measurement phase describes the status of the IDS-20a sensors. It is returned with the analysis values at indices 26 and 40 and has the following format:

AA . BC

The labels are coded as follows:

| Label | Description |
|-------|---|
| AA | Sensor status, see Sensor status |
| B | Icing verification result of sensor 2, see Icing verification results |
| C | Icing verification result of sensor 1, see Icing verification results |



EXAMPLE

| | |
|--------|--|
| 4 . 00 | Cube 5 sensor is heating Icing-criteria for both sensors are satisfied |
| 2 . 04 | Cube 5 sensor is cooling down Icing-criteria of Rod T 80 sensor are satisfied Temperature of Cube 5 sensor is too high |
| 0 . 44 | Both sensors are in normal measurement mode Temperature of both sensors is too high |
| 0 . 00 | Both sensors are in normal measurement mode Icing-criteria for both sensors are satisfied |

A.1 Sensor status

The sensor status **AA** can take the values listed in [Sensor status](#).

A.2 Icing verification

The IDS-20a uses the prevailing environmental conditions to verify the icing measured by the ice-sensors. Ice can only accrete on a sensor surface if the following conditions are satisfied:

- The sensor surface temperature must be below the limit specified in [Maximum temperature](#).
- The relative humidity must exceed the limit value specified in [Minimum humidity](#).
- The water content on the sensor surface must be below the limit value specified in [Maximum water](#).

The icing verification values **B** and **C** can take the values listed in [Icing verification results](#).



| Value | Description | Comment |
|-------|---|--|
| -1 | Measurements are off | Above a specified ambient temperature the IDS-20a does not perform any icing-measurements. |
| 0 | Measurement active | Normal measurement mode |
| 1 | Determination of icing rate | Determines icing rate after cool down |
| 2 | Cool down, waiting time | After a heating cycle the sensor cools down to ambient temperature. |
| 3 | Subsequent heating | Sensor is heated after heating phase 4, 5 or 6 to ensure that the surface is completely dry. |
| 4 | Heating triggered by Ice, maximum | Sensor exceeds Ice, maximum value. Heating is on until ice and water layer thickness fall below Ice, minimum and Water, minimum or Maximum heating time has elapsed. |
| 5 | Heating triggered by Water, maximum | Sensor exceeds Water, maximum value. Heating is on until ice and water layer thickness fall below Ice, minimum and Water, minimum or Maximum heating time has elapsed. |
| 6 | Heating triggered by Ice rate, minimum | Icing rate falls below Ice rate, minimum . Heating is on until ice and water layer thickness fall below Ice, minimum and Water, minimum or Maximum heating time has elapsed. |
| 14 | Heating triggered by frost suppression, ice | Sensor exceeds Ice, minimum , stays below Ice limit of relay A or B and exceeds time limit of Duration frost suppression . Heating is on until ice and water layer thickness fall below Ice, minimum and Water, minimum or Maximum heating time has elapsed. |
| 15 | Heating triggered by frost suppression, water | Sensor exceeds Water, minimum , stays below Water limit of relay A or B and exceeds time limit of Duration frost suppression . Heating is on until water layer thickness fall below Water, minimum or Maximum heating time has elapsed. |

Sensor status

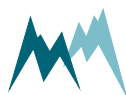

| Value | Description | | |
|-------|---|---------------------------|-----------------------------|
| 0 | all icing-criteria are satisfied | | |
| 1 | water content too high | | |
| 2 | | relative humidity too low | |
| 3 | water content too high | relative humidity too low | |
| 4 | | | sensor temperature too high |
| 5 | water content too high | | sensor temperature too high |
| 6 | | relative humidity too low | sensor temperature too high |
| 7 | water content too high | relative humidity too low | sensor temperature too high |
| 8 | Switch on delay elapses | | |

Icing verification results

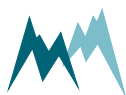

Appendix B Troubleshooting

| | | |
|-------|--|-----|
| B.1 | Devices | 136 |
| B.1.1 | The IDS-20a is not responding or returns unreadable characters | 136 |
| B.1.2 | The IDS-20a reboots repeatedly | 138 |
| B.2 | Measurement data | 138 |
| B.2.1 | Measurement data are not updated | 138 |
| B.2.2 | No data from the ice detection sensor are returned | 138 |
| B.3 | Firmware & software | 138 |
| B.3.1 | Commander loads wrong setup | 138 |
| B.3.2 | Firmware update via RS-485 is aborted | 139 |
| B.4 | RS-485 | 139 |
| B.4.1 | Configuration via terminal shows unexpected behavior | 139 |
| B.5 | SDI-12 | 139 |
| B.5.1 | The IDS-20a is not detected by a SDI-12 master device | 139 |
| B.5.2 | Data logger receives no SDI-12 data | 140 |
| B.6 | Modbus | 140 |
| B.6.1 | Modbus function 04 returns obscure measurement values | 140 |

B.1 Devices

B.1.1 The IDS-20a is not responding or returns unreadable characters

| Reason | Solution |
|---|---|
| The power supply is not connected or turned off. | Check if the power supply is connected and on. |
| The polarity of connected power supply wires is wrong. | Check the polarity of connected wires. |
| Wrong sensor cable. | Use the original sensor cable configured by Sommer Messtechnik (only applicable to Sommer Messtechnik cables). |
| Power supply is insufficient. The IDS-20a requires a certain inrush-current that the power supply is not able to provide. | <ol style="list-style-type: none"> 1. Use a power supply providing >0.5 A at 12 VDC or a fully charged battery. 2. In case of long sensor cables (>50 m) use a 24-VDC power supply. Please note that power supplied by the USB-port is insufficient to power the IDS-20a! |
| The power supply voltage is out of range. | Adjust the power supply to match the specified voltage range. |

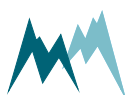

| Reason | Solution |
|---|---|
| The polarity of the connected RS-485-A and RS-485-B wires is wrong. | Reverse the polarity of the connected RS-485-A and RS-485-B wires. |
| The port settings of the IDS-20a and the data acquisition system do not match. | Use the Commander Communication assistant or adapt port settings on your device.  NOTE Sommer Messtechnik devices require the following Baud rates: <ul style="list-style-type: none"> ● Sensor: 9600 ● Data logger: 115200 ● Modbus: 19200 In case of doubt use the function Check port in the Communication assistant . |
| The IDS-20a is set to Modbus. | Connect to the sensor using the Communication assistant of the Commander and select the Modbus option in the Serial connection . |
| A sensor wire is not connected firmly to the terminal of the data acquisition device. | Check the firm connection of the sensor wires. |
| A pin of the connector plug is bent or broken. | Verify that all connector pins are straight. |
| The sensor cable is damaged. | Replace the sensor cable. |
| The COM-port has not been assigned correctly to the USB converter. | <ol style="list-style-type: none"> 1. Make sure to use a Sommer Messtechnik USB converter. Third party converters are not supported. 2. Check the COM-port number using Windows Device Manager. 3. Plug in the USB converter first, then start Commander. |
| The USB converter is faulty. | Replace the USB converter. |
| The USB port on your PC is not working. | Use another USB port. |
| The driver of the USB converter was incorrectly installed | Reinstall the driver of the USB converter. |

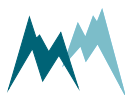

B.1.2 The IDS-20a reboots repeatedly

| Reason | Solution |
|---|--|
| The power supply has not enough current to start the IDS-20a. | Verify that the power supply provides enough current. A IDS-20a consumes up to 140 mA @ 12 V. If required, power the IDS-20a by an additional or alternative supply. |

B.2 Measurement data

B.2.1 Measurement data are not updated

The device is connected to the Commander, but the data are not updated.

| Cause | Solution |
|-----------------------|---|
| Data traffic conflict | Reboot the device by interrupting the power supply. |

B.2.2 No data from the ice detection sensor are returned

| Cause | Solution |
|---|---|
| Ambient temperature is too high. This may be the case if the IDS-20a is tested in the summer. | Increase “OFF” turn off temperature to a value higher than ambient. |

B.3 Firmware & software

B.3.1 Commander loads wrong setup

If the setup is reloaded from the device the Commander seems to display an old version.

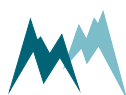

| Cause | Solution |
|---|--|
| The device has been connected to the same PC before and several different setup files have been loaded. | <ul style="list-style-type: none"> • In the Communication section of the Commander, select Mode Connection and click on the trash can icon on the right edge. Then, reload the setup from the device. • Delete the setup files of the device that have been downloaded by Commander to the folder <code>C:\Users\Public\Documents\Sommer\Setup</code>. The respective files can be identified by the serial number in the file name and the file date. |

B.3.2 Firmware update via RS-485 is aborted

| Reason | Solution |
|--|--|
| USB to RS-485 converter cable is damaged or can only operate on 9600 baud. | Replace USB to RS-485 converter cable. The programmer requires 57600 baud. |

B.4 RS-485

B.4.1 Configuration via terminal shows unexpected behavior

Accessing the parameter menus in the terminal leads to unexpected behavior, e.g. after entering a menu character the terminal displays repeated error messages or jumps out of the parameter menu.

| Reason | Solution |
|--|--|
| The sensor, power supply and PC/laptop do not share the same ground. | Verify that all equipment is connected to the same ground. |

B.5 SDI-12

B.5.1 The IDS-20a is not detected by a SDI-12 master device

| Reason | Solution |
|---|---|
| The IDS-20a and the SDI-12 master have different grounds. | Verify that the IDS-20a and the SDI-12 master are connected by a ground (GND) wire. |

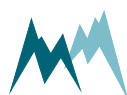

B.5.2 Data logger receives no SDI-12 data

| Reason | Solution |
|--|--|
| The sensor is set to Measurement trigger <i>interval</i> , but the data logger sends a M! command, i.e. the data logger polls data. | If data are polled from the sensor, Measurement interval must be set to SDI-12/RS485 . |
| The sensor is set to Measurement trigger <i>SDI-12/RS485</i> , but the data logger sends an R! command, i.e. the sensor pushes data. | If the sensor pushes data, Measurement interval must be set to <i>interval</i> . |

B.6 Modbus

B.6.1 Modbus function 04 returns obscure measurement values

| Reason | Solution |
|--|--|
| Sensor does not run in its own measurement interval, i.e., MeasuremenSet Mt trigger is not set to <i>Interval</i> . | Set Measurement trigger of the sensor to <i>Interval</i> . A Modbus master can only read measurement data, it cannot trigger measurements. |
| A second Modbus master is present in the RS-485 bus. | Make sure that only one Modbus master is communicating with the Modbus slaves. |
| The signal wires between the Modbus master and the slaves are long and/or the ground potentials of the devices are different. | <ul style="list-style-type: none"> ● Connect the grounds of the devices with an additional wire. ● Reduce the cable length. |
| Endianness of the Modbus polling unit is swapped. Generally, test values and measurement values are set to big endian. Older firmware versions may return measurement values as little endian. | If the device runs on an older firmware, convert the measurement values to float with little endian. |

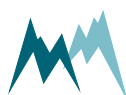

Appendix C CRC-16 array

CRC-16 array

```
1  crc16tab[] =
2  {
3  0x0000, 0x1021, 0x2042, 0x3063, 0x4084, 0x50A5, 0x60C6, 0x70E7,
4  0x8108, 0x9129, 0xA14A, 0xB16B, 0xC18C, 0xD1AD, 0xE1CE, 0xF1EF,
5  0x1231, 0x0210, 0x3273, 0x2252, 0x52B5, 0x4294, 0x72F7, 0x62D6,
6  0x9339, 0x8318, 0xB37B, 0xA35A, 0xD3BD, 0xC39C, 0xF3FF, 0xE3DE,
7  0x2462, 0x3443, 0x0420, 0x1401, 0x64E6, 0x74C7, 0x44A4, 0x5485,
8  0xA56A, 0xB54B, 0x8528, 0x9509, 0xE5EE, 0xF5CF, 0xC5AC, 0xD58D,
9  0x3653, 0x2672, 0x1611, 0x0630, 0x76D7, 0x66F6, 0x5695, 0x46B4,
10 0xB75B, 0xA77A, 0x9719, 0x8738, 0xF7DF, 0xE7FE, 0xD79D, 0xC7BC,
11 0x48C4, 0x58E5, 0x6886, 0x78A7, 0x0840, 0x1861, 0x2802, 0x3823,
12 0xC9CC, 0xD9ED, 0xE98E, 0xF9AF, 0x8948, 0x9969, 0xA90A, 0xB92B,
13 0x5AF5, 0x4AD4, 0x7AB7, 0x6A96, 0x1A71, 0x0A50, 0x3A33, 0x2A12,
14 0xDBFD, 0xCBDC, 0xFBBF, 0xEB9E, 0x9B79, 0x8B58, 0xBB3B, 0xAB1A,
15 0x6CA6, 0x7C87, 0x4CE4, 0x5CC5, 0x2C22, 0x3C03, 0x0C60, 0x1C41,
16 0xEDAE, 0xFD8F, 0xCDEC, 0xDDCD, 0xAD2A, 0xBD0B, 0x8D68, 0x9D49,
17 0x7E97, 0x6EB6, 0x5ED5, 0x4EF4, 0x3E13, 0x2E32, 0x1E51, 0x0E70,
18 0xFF9F, 0xEFBE, 0xDFDD, 0xCFFC, 0xBF1B, 0xAF3A, 0x9F59, 0x8F78,
19 0x9188, 0x81A9, 0xB1CA, 0xA1EB, 0xD10C, 0xC12D, 0xF14E, 0xE16F,
20 0x1080, 0x00A1, 0x30C2, 0x20E3, 0x5004, 0x4025, 0x7046, 0x6067,
21 0x83B9, 0x9398, 0xA3FB, 0xB3DA, 0xC33D, 0xD31C, 0xE37F, 0xF35E,
22 0x02B1, 0x1290, 0x22F3, 0x32D2, 0x4235, 0x5214, 0x6277, 0x7256,
23 0xB5EA, 0xA5CB, 0x95A8, 0x8589, 0xF56E, 0xE54F, 0xD52C, 0xC50D,
24 0x34E2, 0x24C3, 0x14A0, 0x0481, 0x7466, 0x6447, 0x5424, 0x4405,
25 0xA7DB, 0xB7FA, 0x8799, 0x97B8, 0xE75F, 0xF77E, 0xC71D, 0xD73C,
26 0x26D3, 0x36F2, 0x0691, 0x16B0, 0x6657, 0x7676, 0x4615, 0x5634,
27 0xD94C, 0xC96D, 0xF90E, 0xE92F, 0x99C8, 0x89E9, 0xB98A, 0xA9AB,
28 0x5844, 0x4865, 0x7806, 0x6827, 0x18C0, 0x08E1, 0x3882, 0x28A3,
29 0xCB7D, 0xDB5C, 0xEB3F, 0xFB1E, 0x8BF9, 0x9BD8, 0xABBB, 0xBB9A,
30 0x4A75, 0x5A54, 0x6A37, 0x7A16, 0x0AF1, 0x1AD0, 0x2AB3, 0x3A92,
31 0xFD2E, 0xED0F, 0xDD6C, 0xCD4D, 0xBDAA, 0xAD8B, 0x9DE8, 0x8DC9,
32 0x7C26, 0x6C07, 0x5C64, 0x4C45, 0x3CA2, 0x2C83, 0x1CE0, 0x0CC1,
33 0xEF1F, 0xFF3E, 0xCF5D, 0xDF7C, 0xAF9B, 0xBFBA, 0x8FD9, 0x9FF8,
34 0x6E17, 0x7E36, 0x4E55, 0x5E74, 0x2E93, 0x3EB2, 0x0ED1, 0x1EF0
35 }
```

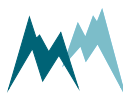

Glossary

I

IP-Call

A technology that provides communications services (voice, SMS, voice-messaging) over the Internet, rather than via the public telephone network.

M

Modbus

A serial communications protocol for connecting industrial electronic devices.

R

RS-485

A standard defining the signal transmission in serial communication systems.

S

SBP

Sommer Bus Protocol

SDI-12

Asynchronous serial communications protocol for intelligent sensors (Serial Digital Interface at 1200 baud)

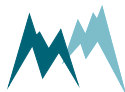

Index

M

Modbus 24-25, 58, 60, 86-87, 93, 95-96,
111-112, 127, 137, 140

R

RS-485 14, 24-25, 27, 29, 32, 42, 60, 68-70,
77, 86-87, 96, 110-111, 126-127, 137,
139-140

S

SDI-12 24-25, 27, 29, 60, 69, 80-85, 89, 108,
126-127, 139-140

