

# MRL-8P

Data logger

## Manual

Setup version 1.14.00 (Firmware 1.22.00)

10.09.2024



Sommer Messtechnik

All rights reserved.

The Copyrights for this manual are exclusively owned by

Sommer Messtechnik  
6842 Koblach  
Austria

This manual or parts of it may only be copied or passed on to third parties with written permission of Sommer Messtechnik. This applies to printed as well as digital issues of this manual.



Sommer Messtechnik  
Strassenhäuser 27  
6842 Koblach  
Austria  
[www.sommer.at](http://www.sommer.at)  
E [office@sommer.at](mailto:office@sommer.at)  
T +43 5523 55989  
F +43 5523 55989-19

## Validity

This manual applies to the Data logger with the setup version 1.14.00, including all its subversions.

Created: 11.09.2024

Last update: 10.09.2024

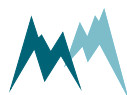

# EU conformity



This product is in conformity with the following standards:

EMC	2014/30/EU	EN 301 489-1 V1.9.2
LVD	2014/35/EU	EN 62311:2008
		EN 62368-1:2014
RoHS II	2011/65/EU	
RoHS III	2015/863/EU	

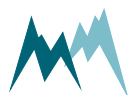

# Safety information

Please read this manual carefully before installing or operating this equipment. Non-compliance with the instructions given in this manual can result in failure or damage of the equipment or may put people at risk by injuries through electrical or mechanic impact.

- Make sure that the personnel responsible for installation, configuration and maintenance is familiar with the applicable regulations and standards!
- Do not perform any installations in bad weather conditions, e.g. thunderstorms.
- Prior to installation of equipment inform the owner of the measurement site or the authority responsible for it. Upon completion, secure the installation from trespassers.
- Maintenance and repair must be performed by trained personnel or an engineer of Sommer Messtechnik. Only replacement parts supplied by Sommer Messtechnik should be used for repairs.
- Make sure that NO power is connected to the equipment during installation and wiring!
- Only use a power supply that complies with the power rating specified for this equipment!
- Keep equipment dry during wiring and maintenance!
- If applicable, it is recommended to use accessories of Sommer Messtechnik with this equipment.

## Disposal



After this device has reached the end of its lifetime, it must not be disposed of with household waste! Instead, dispose of the device by returning it to a designated collection point for the recycling of waste electrical and electronic equipment.

Dispose of batteries separately!



## Feedback

Should you come across any error in this manual, or if you miss information to handle and operate the MRL-8P we are pleased to receive your feedback to [office@sommer.at](mailto:office@sommer.at).

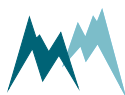

# Content

- 1 What is the MRL-8P? ..... 16
- 2 Unpacking ..... 17
- 3 How do I start? ..... 18
  - 3.1 Connect the MRL-8P to a PC .....18
  - 3.2 Configure the MRL-8P .....18
  - 3.3 View live measurements ..... 19
- 4 What can I do with it? .....20
  - 4.1 Measurement options ..... 21
    - 4.1.1 Analog measurements ..... 21
    - 4.1.2 Counts & frequency ..... 21
    - 4.1.3 SDI-12 data acquisition ..... 22
    - 4.1.4 Serial RS-485 data acquisition .....22
  - 4.2 Sensor power supply ..... 22
  - 4.3 Communication options ..... 23
    - 4.3.1 Direct connection to a PC ..... 23
    - 4.3.2 Bluetooth ..... 23
  - 4.4 Ethernet ..... 23
    - 4.4.1 Modem ..... 23
    - 4.4.2 Socket connection ..... 23
    - 4.4.3 Radio connection ..... 23
  - 4.5 Satellite modem (optional) ..... 24
  - 4.6 Data storage options ..... 24
    - 4.6.1 Internal data storage ..... 24
    - 4.6.2 USB flash drive ..... 24
    - 4.6.3 Remote data storage ..... 24
- 5 Versions ..... 25
- 6 Specifications .....26
- 7 Components ..... 28
  - 7.1 Terminals ..... 28
  - 7.2 Ethernet ..... 31
- 8 Installation ..... 32
  - 8.1 Where should I install the MRL-8P? .....32
  - 8.2 How do I install the MRL-8P? ..... 32
    - 8.2.1 Mounting ..... 32
    - 8.2.2 Power supply ..... 33
    - 8.2.3 Signal cables ..... 34
    - 8.2.4 Surge protection ..... 34



9	Operation .....	35
9.1	How to use the keyboard .....	35
9.1.1	Keyboard buttons .....	35
9.1.2	Display menu .....	36
9.1.3	Activating the display .....	37
9.1.4	Switching off the display .....	37
9.1.5	Displaying the latest measurement values .....	37
9.1.6	Replace and adjust a measurement value .....	37
9.1.7	Reading and changing a setting .....	38
9.2	How to open the data logger housing .....	40
9.3	How to use the spring clips .....	41
9.4	How to connect a sensor .....	42
9.5	How to set the clock .....	43
9.6	How to copy data to a USB flash drive .....	43
9.6.1	Copy data since last download .....	43
9.6.2	Copy all data .....	43
9.7	How to insert the SIM card .....	44
9.8	How to activate mobile communication .....	45
9.9	How to do a modem test .....	46
9.10	How to set messages & actions .....	47
9.11	How to enable e-mail .....	49
9.12	How to enable remote access .....	50
9.13	How to activate Ethernet communication .....	52
9.14	How to configure data transmission via Ethernet .....	55
9.15	How to implement external protocol .....	56
9.16	How to react to important events .....	58
9.17	How to set up data transmission targets .....	60
9.18	How to set messages & actions .....	62
9.19	How to replace the internal fuse .....	63
9.20	How to replace the internal lithium battery .....	63
9.21	Data security .....	64
10	Maintenance .....	65
10.1	Calibration .....	65
11	Support software Commander .....	66

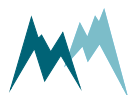

11.1	Software features .....	66
11.2	System requirements .....	66
11.3	Installation of Commander .....	66
11.4	Change authorization .....	71
11.5	Working with connections .....	72
	11.5.1 Establish a connection with the Communication assistant .....	72
	11.5.2 Establish a connection manually .....	72
	11.5.3 Create a new connection .....	72
11.6	Working with stations .....	73
	11.6.1 Create a station with the Communication assistant .....	73
	11.6.2 Create a station manually .....	77
11.7	Working with measurements .....	78
	11.7.1 Poll continuous measurements .....	78
	11.7.2 Record measurements .....	79
11.8	Working with data .....	79
	11.8.1 View live data .....	79
	11.8.2 Collect measurement data .....	80
	11.8.3 View collected data .....	80
11.9	Working with setups .....	81
	11.9.1 Download setup .....	81
	11.9.2 Open a setup file .....	81
	11.9.3 Edit setup .....	81
	11.9.4 Upload new setup file .....	82
11.10	Update firmware .....	82
11.11	Set the device time .....	83
12	Communication with the MRL-8P .....	84
12.1	Options .....	84
	12.1.1 RS-232 using an USB converter .....	84
	12.1.2 Bluetooth .....	88
	12.1.3 Ethernet connection .....	91
	12.1.4 IP-Call .....	95
	12.1.5 Socket connection .....	97
	12.1.6 Radio connection .....	99
12.2	Data output .....	101
	12.2.1 Output values .....	101
	12.2.2 Exception values .....	101
12.3	RS-232 communication .....	102
	12.3.1 Configuration .....	102
	12.3.2 Data output options .....	103

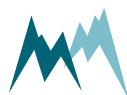

12.3.3	Sommer Bus Protocol (SBP)	103
12.3.4	Standard protocol	106
12.3.5	Serial commands	108
12.3.6	Sommer Messtechnik CRC-16	110
13	Configuration of the MRL-8P	112
13.1	Configuration with Commander support software	112
13.2	Configuration with a terminal program	115
13.3	Configuration errors	116
13.3.1	Conflict messages	116
13.3.2	Parameter conflicts	117
13.3.3	Setup conflicts	119
13.4	What do I need to configure?	120
13.4.1	General settings	120
13.4.2	Measurement table	121
13.4.3	Totalizer reset options	121
13.4.4	Device clock	122
13.4.5	Camera	123
14	Data acquisition examples	124
14.1	Power considerations	124
14.2	Analog measurements	124
14.2.1	Principals	125
14.2.2	Analog input assistant	126
14.2.3	Single ended voltage measurement	127
14.2.4	Differential voltage measurement	127
14.2.5	Current measurement	128
14.2.6	Resistance measurement	129
14.3	Counter & frequency measurements	129
14.3.1	Counting events	129
14.3.2	Frequency measurement	130
14.4	RS-485	130
14.4.1	Principles	130
14.4.2	Multiple RS-485 devices	131
14.4.3	Find RS-485 devices with Commander	132
14.4.4	Reading data from a Sommer Messtechnik RS-485 device	132
14.4.5	Trigger measurements of a Sommer Messtechnik RS-485 device	133
14.4.6	Reading data in MIO-format	134
14.4.7	Serial camera	135
14.5	SDI-12	135
14.5.1	Principles	136

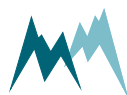

14.5.2	Measurements with an SDI-12 sensor .....	136
15	Parameter definitions .....	138
A	Station ID .....	138
B	Station name .....	138
C	Measurement interval .....	138
D	Storage interval .....	139
E	Measurements, max. number .....	139
F	Aux measurements, max. number .....	139
G	Measurement table .....	140
H	Messages, table .....	148
H-A	Min. Hold on message .....	149
H-B	Max. Hold on message .....	149
H-C	E-mail/SMTP .....	150
H-C-A	E-mail/SMTP .....	150
H-C-B	Sender .....	150
H-C-C	Username .....	150
H-C-D	Password .....	151
H-C-E	Port .....	151
H-C-F	SSL/TLS .....	151
H-D	Messages, table .....	151
I	Add. intervals .....	153
I-A	Measurement interval wind .....	153
I-B	Measurement interval SDI .....	154
I-C	Measurement interval RS485 .....	154
I-D	Secondary storage intervals .....	154
I-E	Interval accel. (SU) .....	155
I-E-A	Measuring and Storage .....	155
I-E-B	Datatransmission .....	155
I-E-C	Picture release .....	155
J	Network .....	156
J-A	Operation .....	156
J-B	Modem config .....	156
J-B-A	SIM pin .....	156
J-B-B	Net type .....	157
J-B-C	Foreign operator mcc&mnc .....	157
J-B-D	Operator select .....	157
J-B-E	APN address .....	158
J-B-F	APN user name .....	158
J-B-G	APN password .....	158

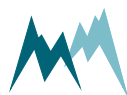

	J-B-H	Custom command 1	158
	J-B-I	Custom command 2	159
J-C		Ethernet config	159
	J-C-A	Power ext. LAN	159
	J-C-B	Warm-up ext. LAN	159
	J-C-C	Power MEE	159
	J-C-D	Warm-up MEE	160
	J-C-E	TCP timeout	160
J-D		Data transmission 1	160
	J-D-A	Target server type	161
	J-D-B	Access	161
	J-D-C	Data transmission interval	161
	J-D-D	Data transmission offset	162
	J-D-E	Content	162
	J-D-F	FTP server name	162
	J-D-G	FTP user name	163
	J-D-H	FTP password	163
	J-D-I	FTP directory	163
	J-D-J	FTP port	163
	J-D-K	FTP mode	163
	J-D-L	HTTP server name	163
	J-D-M	HTTP basic authentication	164
	J-D-N	HTTP basic user name	164
	J-D-O	HTTP basic password	164
	J-D-P	HTTP path	164
	J-D-Q	HTTP port	164
J-E		Data transmission 2	164
J-F		Data transmission 3	165
J-G		Data transmission 4	165
J-H		Remote config	165
	J-H-A	IP Call password	165
	J-H-B	Time window 1	165
		J-H-B-A Connection	165
		J-H-B-B Access	166
		J-H-B-C Standby, start time	166
		J-H-B-D Standby, duration	166
		J-H-B-E IP Call server	166
		J-H-B-F IP Call port	167
		J-H-B-G IP Call interval	167

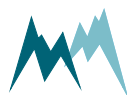

	J-H-C	Time window 2	167
		J-H-C-A Connection	167
		J-H-C-B Access	167
		J-H-C-C Standby, start time	168
		J-H-C-D Standby, duration	168
		J-H-C-E IP Call server	168
		J-H-C-F IP Call port	168
		J-H-C-G IP Call interval	168
J-I		Time	169
	J-I-A	Source	169
	J-I-B	Access	169
	J-I-C	Synchronization time	169
	J-I-D	NTP server	170
	J-I-E	NTP port	170
	J-I-F	Check deviation	170
	J-I-G	Deviation	170
K		External sat-modem	171
	K-A	Use	171
	K-B	Data transmission interval	171
	K-C	Data transmission offset	171
	K-D	Data coupling	171
L		Technics	172
	L-A	SBP device addressing	172
		L-A-A Device number	172
		L-A-B System key	172
		L-A-C Enable network scan	173
	L-B	COM	173
		L-B-A Output protocol	173
		L-B-A-A Protocol type	173
		L-B-A-B Measurement output	174
		L-B-A-C Information	174
		L-B-A-D Wake-up sequence	174
		L-B-A-E Prefix holdback	175
		L-B-B Port	175
		L-B-B-A Baud rate	175
		L-B-B-B Parity, stop bits	176
		L-B-B-C Minimum response time	176
		L-B-B-D Flow control	176
L-C		Inputs	177



L-C-A	RS-485 .....	177
	L-C-A-A Sensor supply (always on) .....	178
	L-C-A-B SBP sensor feedback .....	178
	L-C-A-B-A Measurement output .....	178
	L-C-A-B-B Information .....	178
	L-C-A-B-C Wake-up sequence .....	179
	L-C-A-B-D Prefix holdback .....	179
	L-C-A-C Port .....	179
	L-C-A-C-A Baud rate .....	180
	L-C-A-C-B Parity, stop bits .....	180
	L-C-A-C-C Minimum response time .....	180
	L-C-A-C-D Transmitter warm-up time .....	181
	L-C-A-C-E Flow control .....	181
	L-C-A-C-F Sending window .....	181
	L-C-A-C-G Receiving window .....	181
	L-C-A-C-H Transparency to RS485 A/B .....	182
	L-C-A-D Trigger .....	182
	L-C-A-D-A Polling .....	182
	L-C-A-D-B Timeout .....	182
	L-C-A-D-C Sleep while timeout .....	183
	L-C-A-D-D Polling delay .....	183
	L-C-A-E Ext. Protocol (EXT)1 .....	183
	L-C-A-E-A Function .....	183
	L-C-A-E-B Length .....	184
	L-C-A-E-C Separator .....	184
	L-C-A-E-D Start chars .....	184
	L-C-A-E-E Stop chars .....	184
	L-C-A-E-F Polling chars .....	184
	L-C-A-E-G Recv timeout .....	184
	L-C-A-E-H Binary .....	184
	L-C-A-E-I Pos. separ. ....	185
	L-C-A-E-J Test .....	185
	L-C-A-F Ext. Protocol (EXT)2 .....	185
	L-C-A-G Ext. Protocol (EXT)3 .....	185
	L-C-A-H Ext. Protocol (EXT)4 .....	185
	L-C-A-I Show hex data .....	186
L-C-B	SDI-12 Master .....	186
	L-C-B-A Max. measurement duration .....	186
	L-C-B-B Sensor supply (always on) .....	186

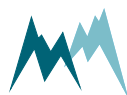

	L-C-B-C	Sensor search .....	186
	L-C-B-D	Change sensor address .....	186
	L-C-B-E	Get sensor address .....	187
	L-C-B-F	Transparency to SDI-12 .....	187
L-C-C		Analog inputs .....	187
	L-C-C-A	Warm-up time .....	187
	L-C-C-B	ADC - conv. Rate .....	187
	L-C-C-C	ADC filter .....	188
	L-C-C-D	AN3 (N) type .....	188
	L-C-C-E	AN4 (D) type .....	189
	L-C-C-F	Sensor supply .....	189
		L-C-C-F-A 5V .....	189
		L-C-C-F-B 12V .....	189
		L-C-C-F-C Extended supply (switched) .....	190
		L-C-C-F-D Switch X21, Camera 1 .....	190
L-C-D		Additional meas. settings .....	191
	L-C-D-A	Wind speed measurement duration .....	191
	L-C-D-B	Storage interval asynchronous .....	191
	L-C-D-C	Sum, reset time .....	192
	L-C-D-D	X20 reset .....	192
	L-C-D-E	Monthly event, day of month .....	192
	L-C-D-F	Conversion table A .....	192
	L-C-D-G	Conversion table B .....	193
L-C-E		RS485 Camera .....	193
	L-C-E-A	Quantity .....	193
	L-C-E-B	Switch X21, Camera 1 .....	193
	L-C-E-C	Switch X21, Camera 2 .....	194
	L-C-E-D	Warm-up time .....	194
	L-C-E-E	Solar nightshutdown .....	194
	L-C-E-F	View .....	195
L-D		Additional settings .....	195
	L-D-A	Sommer ID .....	195
	L-D-B	Block size, data load .....	195
	L-D-C	Internal low volt. disconnect .....	196
	L-D-D	SommerXF starts with BOM .....	196
	L-D-E	Display access .....	197
	L-D-F	LCD, Contrast .....	197
	L-D-G	LCD, Brightness .....	197
	L-D-H	Transmission file size .....	198

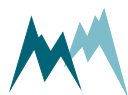

	L-D-I	Network timeout factor .....	198
M		Region format .....	198
	M-A	Language/Sprache .....	198
	M-B	Decimal character .....	199
	M-C	Timezone .....	199
N		Special functions .....	199
	N-A	Device status .....	200
	N-B	Last date sync. ....	200
	N-C	Last time sync. ....	200
	N-D	View setup .....	200
	N-E	Continuous meas. mode (temp). ....	200
	N-F	Set factory default .....	200
	N-G	Temp. load factory default .....	200
	N-H	Relaunch program .....	201
	N-I	Replace program .....	201
Appendix A		Troubleshooting .....	202
	1.1	Configuration errors .....	202
		1.1.1 Conflict messages .....	202
		1.1.2 Parameter conflicts .....	203
		1.1.3 Setup conflicts .....	205
	A.2	Connections .....	207
		A.2.1 Commander cannot connect to the MRL-8P via RS-232 port .....	207
		A.2.2 Commander cannot connect to the MRL-8P by IP call .....	207
		A.2.3 Commander cannot connect to the MRL-8P by socket connection .....	209
	A.3	Devices .....	209
		A.3.1 The MRL-8P is not responding or returns unreadable characters .....	209
		A.3.2 Commander does not find connected RS-485 sensors .....	210
	A.4	Measurement data .....	210
		A.4.1 Measurement data are not updated .....	210
		A.4.2 MRL-8P receives no data from RS-485 (SBP) sensors .....	211
	A.5	RS-485 .....	211
		A.5.1 Configuration via terminal shows unexpected behavior .....	211
	A.6	SDI-12 .....	212
		A.6.1 The MRL-8P is not detected by a SDI-12 master device .....	212
		A.6.2 Data logger receives no SDI-12 data .....	212
	A.7	Counter input .....	213
		A.7.1 The counter input is not working .....	213
	A.8	Camera .....	214
		A.8.1 Camera does not record images .....	214

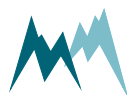

A.8.2	Transmitted images are incomplete .....	214
A.9	Data transmission .....	215
A.9.1	Data are not transmitted to server .....	215
A.10	Notifications .....	216
A.10.1	No message was sent upon limit violation .....	216
A.10.2	I receive repeated messages after limit violation .....	216
A.11	Firmware & software .....	217
A.11.1	Commander loads wrong setup .....	217
A.11.2	Firmware update via RS-232 is aborted .....	217
A.12	Time & date .....	217
A.12.1	Measurement values are one hour behind .....	217
A.12.2	Data logger clock displays year 2050 or 2099 .....	218
Appendix B	Tips & tricks .....	219
B.1	Set a minute counter .....	219
B.2	Set combined limits .....	220
B.3	Perform a delayed action .....	220
B.4	Set a status control .....	221
B.5	Activate a switched output .....	222
B.6	Send a weekly message .....	223
B.7	Monthly reset of summed variables .....	224
B.8	Send multiple SDI-12 requests .....	225
Appendix C	Escape characters .....	227
Appendix D	DIP-switches .....	228
Appendix E	System advice codes .....	232
Appendix F	CRC-16 array .....	233

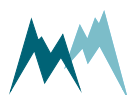

# 1 What is the MRL-8P?

The MRL-8P is a compact data logger designed to acquire, process, store and transmit environmental data. Its waterproof housing, integrated modem and charger make the MRL-8P ideal for remote and autonomous monitoring applications. The MRL-8P is compatible with all sensors offered by Sommer Messtechnik and third-party devices equipped with analog or SDI-12 interface options.

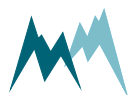

## 2 Unpacking

When unpacking your MRL-8P sensor box please make sure that the following items are present:

Qty.	Name
1	MRL-8P in the required configuration
1	Manual and Commander Software on USB stick
3	Blanking plug for unused cable glands

In case of missing or damaged items please contact your Sommer Messtechnik sales partner.

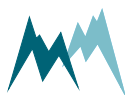

## 3 How do I start?

Follow the steps below to get the first measurement:



**NOTE** Perform the first start-up in your lab or office before installing the equipment in the field!

### 3.1 Connect the MRL-8P to a PC

1. Install the Commander support software (see [Installation of Commander](#)).
2. Connect the RS-232 to USB converter cable to the MRL-8P and a USB port on your PC.
3. Connect a 9...28 VDC power supply to the MRL-8P as shown in the figure below.

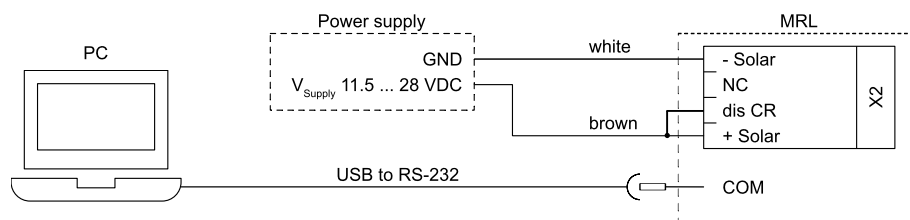

4. Click on **Communication assistant** on the right-hand side of the Commander window and follow the instructions.
  - a. As **Type of connection** select *Serial connection*
  - b. As **Device type** select *Logger (115200 Bd)*
  - c. Select **New connection** and select the COM port

During this procedure the communication assistant will search for connected devices. Upon successful completion, the new connection is added to the connections list (tab **Connections (F8)**).

5. In the **Communication** section at the right-hand side of the Commander window select **Mode Connection** and the previously created connection from the drop-down list.
6. Click **Connect** to establish a connection with the MRL-8P. If the connection was successful a green icon is displayed at the top-right corner of the Commander window.
7. Select the tab **Parameters (F2)** and click **Download parameters from device** on the left side of the Commander window. The complete parameter list is transferred from the sensor to your PC and displayed in the **Parameter** window.

### 3.2 Configure the MRL-8P

1. Select language and decimal character to your needs (menu **Technics**).
2. Set **Measurement interval** and **Storage interval** in the main menu to the desired interval, e.g. 1 minute, i.e. *00:01:00*.

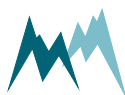

3. Add a measurement channel to the measurement table in the main menu as in the example below (see [Measurement table](#) for details).

 **EXAMPLE**  
**MRL-8P supply voltage as measurement channel**

G Measurements. table													
	Function	Identifier	Unit	Decimals	Scale	Offset		S-TYP	S-NUM	S-MEA	S-ADD	Limit	Messages
01	actual	Supply voltage	V	as S		0.00	Adjustment	Test	SYS	0	+Sup V		

4. Send the parameters to the MRL-8P by clicking [Upload modified parameters to device](#).



**TIP**

To configure the MRL-8P for your application, please read [What do I need to configure?](#) and see [Data acquisition examples](#) for various sensor connections.

To configure remote communication via modem please see [How to activate mobile communication](#).

### 3.3 View live measurements

1. Select the [Measurement \(F3\)](#) tab.
2. In menu [Technics > COM > Output protocol](#) set [Measurement output](#) to [Measurement values push](#).
3. Make sure the connection to the MRL-8P is active (green icon on top right corner of the Commander). The acquired measurements are now displayed in [Measurement values](#) list and the [Measurement data graph](#).



**NOTE**

For further configuration tasks like sensor connection or modem setup please go to section [Operation](#).

To learn more about the Commander software go to section [Support software Commander](#).

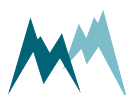

# 4 What can I do with it?

All data logger inputs, outputs and additional features are illustrated in [Figure 1](#).

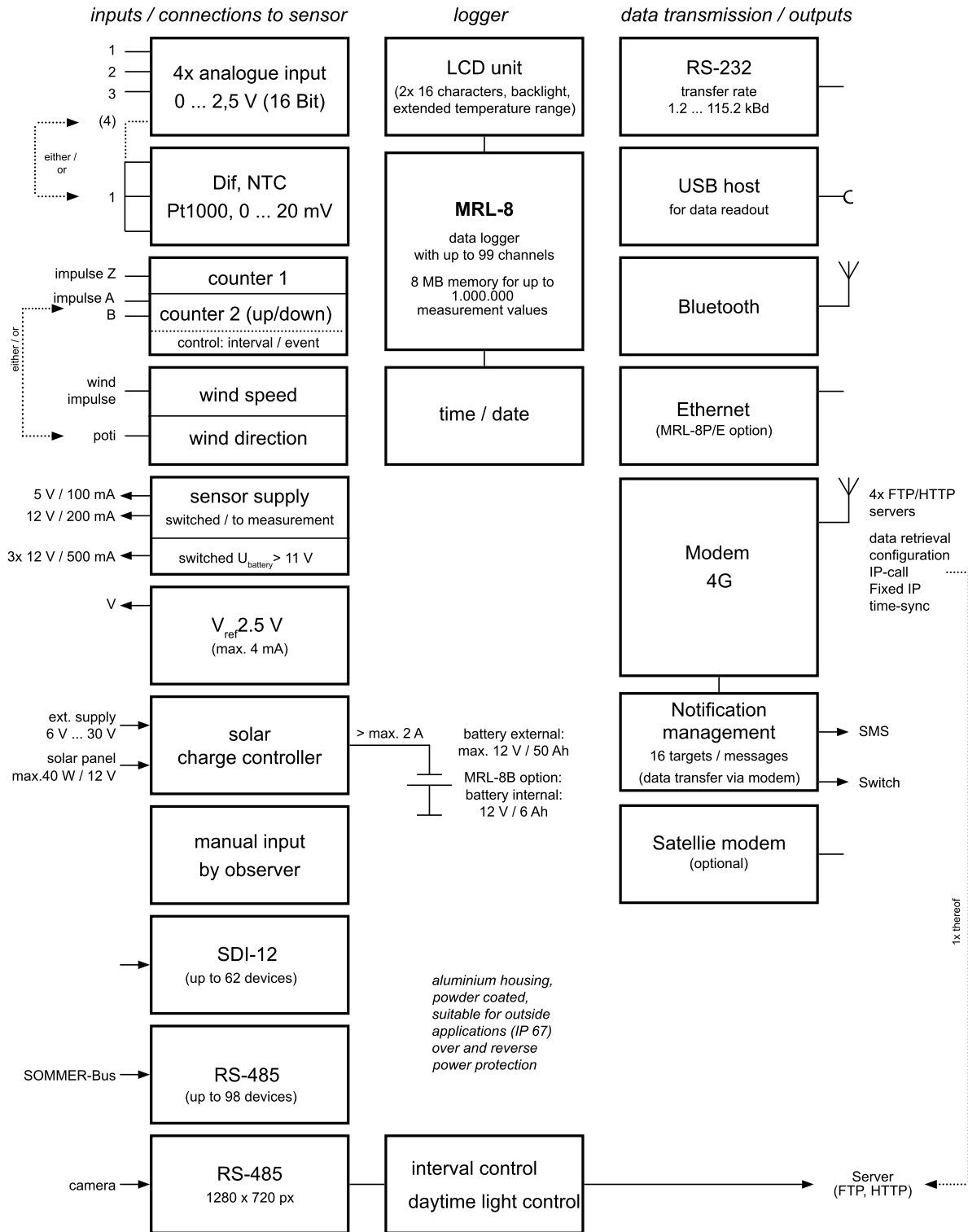
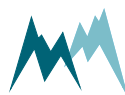

Figure 1 Data logger in- and outputs



## 4.1 Measurement options

The MRL-8P data logger is designed to acquire measurements of the following sensor types:

- Analog sensor with voltage and current output
- Resistive sensors, e.g. wind vanes with potentiometer output
- Sensors with frequency output, e.g. anemometers
- Sensors with pulse output, e.g. tipping bucket rain gauge
- Digital sensors using SDI-12 and Sommer RS-485 protocols

### 4.1.1 Analog measurements

The analog input terminals can be configured to different input signals. The available options are listed below.

Analog input	Measurement options
An 1	0 ... 2.5V
An 2	0 ... 2.5V
An 3	0 ... 2.5V NTC Resistance > 2k $\Omega$
An 4	0 ... 2.5V 0 ... 0.3V Resistance 0 ... 100'000 $\Omega$ Resistance 0 ... 1250 $\Omega$ Pt1000
Wind direction / Counter 2b	Either resistance (potentiometer) or pulse counter for encoder (min. 5V); selected by DIP-switch (see <a href="#">Appendix D</a> )

Analog input terminals

### 4.1.2 Counts & frequency

The available counter and frequency inputs are listed below:

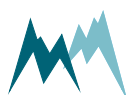

Analog input	Measurement options
Counter 1	Pulse counter (min. 5V), max. frequency 99 Hz; configurable as pull-up or pull down (see <a href="#">Appendix D</a> )
Counter 2	Pulse counter (min. 5V), max. frequency 99 Hz
Wind speed	Dedicated to wind speed only, max. frequency 1 kHz

Counter and frequency input terminals

### 4.1.3 SDI-12 data acquisition

The MRL-8P provides one SDI-12 port for communication with SDI-12 sensors. A total of 62 SDI-12 sensors with the addresses *0...9*, *a...z* and *A...Z* can be connected.

### 4.1.4 Serial RS-485 data acquisition

The RS-485 port of the MRL-8P provides an interface to connect digital SOMMER sensors using the Sommer Bus Protocol (SBP). A total of 98 Sensors with addresses *01...98* can be connected (by default the MRL-8P has address *00*).

## 4.2 Sensor power supply

Sensors can be powered by the voltage supply terminals listed below. Please consult the sensor manual for information on power requirements.

Output	Maximum load	
5V-Out	max. 100 mA	
12V-Out	max. 200 mA	
2.5V Reference	4 mA	
9...28 VDC supply	1 x 1.10 A	max. 2 A
Switched 9...28 VDC supplies	3 x 0.50 A	

Voltage supply terminals

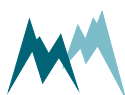

## 4.3 Communication options

### 4.3.1 Direct connection to a PC

Communication between the MRL-8P and a PC can be established with the supplied USB to RS-232 converter. The Commander software or any terminal editor can be used to view and edit the data logger settings. Among others, the Commander provides a [Communication assistant](#) to connect to the data logger.

### 4.3.2 Bluetooth

A connection between the MRL-8P and your PC can also be established via Bluetooth. If your PC is equipped with an internal or external Bluetooth-device, the [Communication assistant](#) of the Commander software can connect to the data logger (see [Bluetooth](#) for detailed instructions).

## 4.4 Ethernet

The MRL-8P is equipped with an Ethernet connection. This allows remote communication with the data logger via IP-call, HTTP/FTP data transfer and time synchronization via NTP.

### 4.4.1 Modem

The MRL-8P is equipped with a wireless 4G-modem that can use the 2G, 3G and 4G services. This allows remote communication with the data logger via IP-call, HTTP/FTP data transfer, SMS-messages as well as time synchronization via NTP.

### 4.4.2 Socket connection

The socket of the MRL-8P can be used for a direct TCP/IP connection. This option may be used by organizations with their own APN that allows a static IP address.

### 4.4.3 Radio connection

Sommer Messtechnik offers ultra narrow band radios for remote communication between the MRL-8P and a base station, or between one or multiple sensors and the MRL-8P as base station. See [Sommer radio devices](#) for available products.

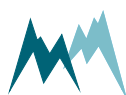

## 4.5 Satellite modem (optional)

The Sommer Messtechnik SATMO-6100 delivers reliable global communication over the Inmarsat satellite service for uninterrupted visibility of operations and access to critical field data in even some of the world's most remote locations. Because of its two-way connectivity, users can remotely control, check and calibrate equipment without sending workers to the field. The SATMO-6100 consumes very little power and is ideal for autonomous solar powered applications.

## 4.6 Data storage options

### 4.6.1 Internal data storage

Acquired measurement data are stored in a flash memory of 8 MB. This is equivalent to up to 1.000.000 values, depending on resolution and the number of acquired variables.

### 4.6.2 USB flash drive

Data stored internally can be collected on a USB flash drive. After connection to the data logger and a keyboard command all data since the last collection are transferred to the USB flash drive. See [How to copy data to a USB flash drive](#) for detailed instructions.

### 4.6.3 Remote data storage

The acquired data stored in the data logger can be transmitted to a HTTP or FTP server. A maximum of 4 servers, each with a different transmission interval, can be configured. At the end of each interval the latest image or all data since the last successful transmission are sent. See [How to set up data transmission targets](#) for detailed instructions.

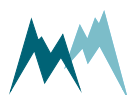

## 5 Versions

Art	Version
21927	MRL-8 data logger with integrated 4G modem (Europe), solar charger
22015	MRL-8B data logger with integrated 4G modem (Europe), solar charger, 6 Ah lead-acid battery
20062	MRL-8E data logger with integrated Ethernet and 4G modem (Europe), solar charger
22023	MRL-8P data logger with integrated Ethernet and 4G modem (Europe), third-party protocol, solar charger
22142	MRL-8 data logger with integrated 4G modem (North America), solar charger
22143	MRL-8B data logger with integrated 4G modem (North America), solar charger, 6 Ah lead-acid battery
22141	MRL-8E data logger with integrated Ethernet and 4G modem (North America), solar charger
22144	MRL-8P data logger with integrated Ethernet and 4G modem (North America), third-party protocol, solar charger

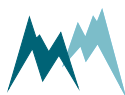

## 6 Specifications

Device specifications	
Power supply	9...28 VDC; Overvoltage and reverse voltage protection Solar panel supply: max. 40 W/12 V
Power consumption	Active: <23 mA @12V Standby: <0.6 mA @ 12V @ <a href="#">Terminals</a>
Sensor supply	100 mA @ 5V 200 mA @ 12V 1x 1.10 A and 3 x 0.50 A @ switched supply voltage (max. 2 A in total)
Inputs	4x Analog 0...2.5 V, 16 bit (3 single ended, 1 differential) 2x Counter (one optionally as encoder) 1x Wind speed 1x Wind direction 1x RS-485 (sensor or camera input) 1x SDI-12 (MRL-8P as master) 1x Manual observer input (has no measurement input; only accepts an offset)
Outputs	3x Switch output (each approx. 500 mA @ supply voltage) 1x RS-232 (1200...115200 Baud, ASCII protocol) 1x RS-485 1x Ethernet (RJ45, 10/100Base Mbps, full and half duplex, surge protected) 1x USB 1x Bluetooth
Memory	8 MB internal flash memory (equivalent to approx. 1.000.000 measurement values)
Measurement interval	2 s ... 12 h
Mobile modem	2G, 3G, 4G 4 FTP/FTPS/HTTP/HTTPS servers Functions: IP call, fixed IP, time-synchronization via NTP and SMS if it is supported by the SIM card
Operating temperature	-30 ... 60 °C (-22...140 °F), 10...95 %rH
Storage temperature, humidity	-40 ... 85 °C (-40...185 °F), 10...95 %rH
Protection rating	IP 67

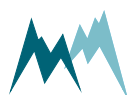

Device specifications	
Housing Size L x W x H without Connectors	180 x 150 x 91 mm (7.09 x 5.91 x 3.58 inch)
Connector height above the housing	+ 27 mm ( + 1.06 inch)
Weight	1610 g (3.55 lb)

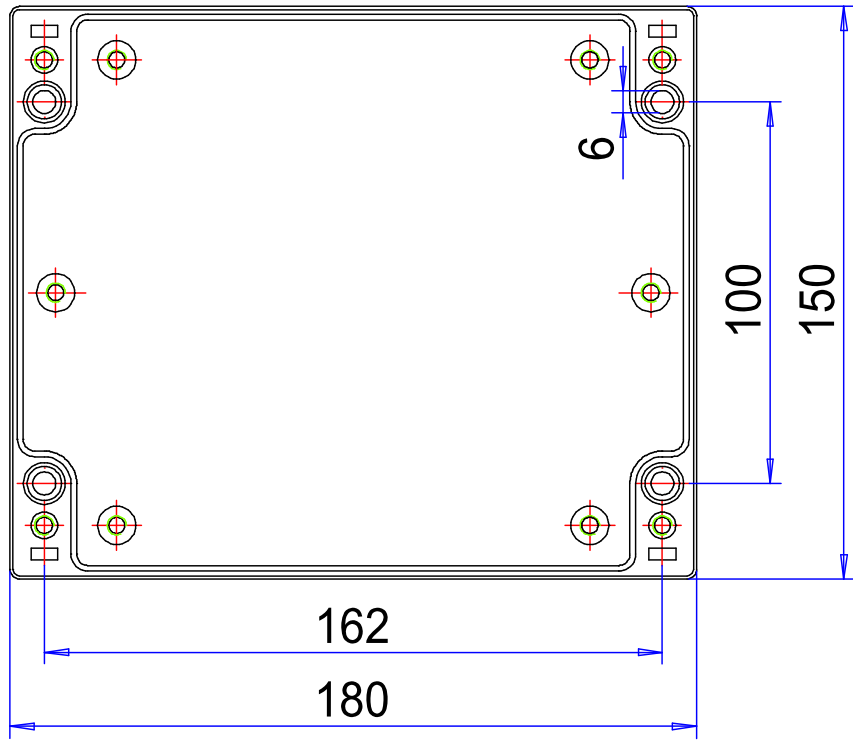

Housing height without Connectors: 91 mm  
 Connector height above the housing: + 27 mm  
 Dimensions MRL-8P



# 7 Components

## 7.1 Terminals

The pin-layout of the MRL-8P is shown in [Figure 2](#) and the terminals are listed in the table below.



**ATTENTION** Do not connect voltages higher than 30 V to any terminal! Excess voltages can impair the functioning of the MRL-8P, destroy the device and may lead to injuries.

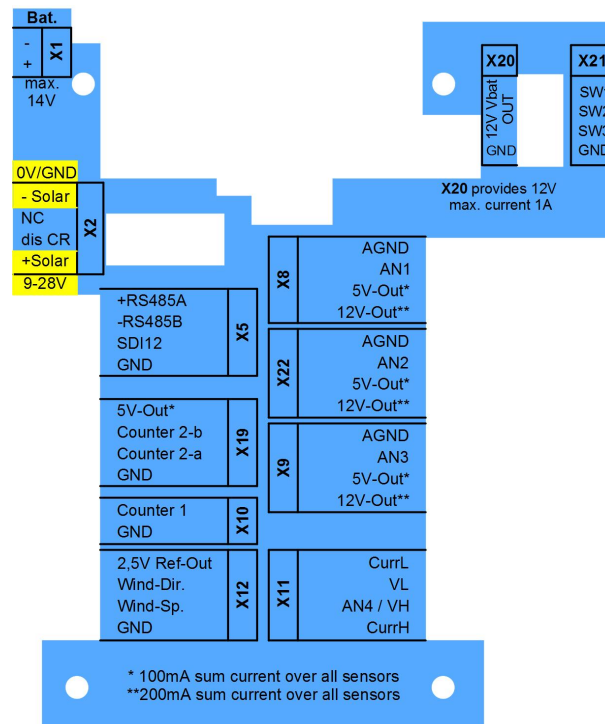
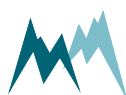

Figure 2 Connection terminals of MRL-8P



Group	Pin	Description
X1	-	Battery connector (-)
	+	Battery connector (+), max. 14 V
X2	- Solar	Supply voltage (-) or solar panel connector (-)
	NC	Not connected. Do not use!
	dis CR	Disabling internal charge regulator
	+ Solar	Supply voltage (+) or solar panel connector (+)
X5	+ RS485A	RS-485 A
	- RS485B	RS-485 B
	SDI12	SDI-12 sensor connector
	GND	Ground
X19	5V-Out	5 V output for sensor supply (max. 100 mA) <sup>1</sup>
	Counter 2-b	Counter 2, secondary input for encoder
	Counter 2-a	Counter 2, primary input for encoder
	GND	Ground
X10	Counter 1	Counter 1 input
	GND	Ground
X12	2.5V Ref-Out	2.5 V reference voltage output
	Wind-Dir.	Wind direction (potentiometer) input
	Wind-Sp.	Wind speed input
	GND	Ground

<sup>1</sup> 100 mA total current for all sensors



Group	Pin	Description
X8	AGND	Analog ground
	AN1	Analog input 1
	5V-Out	5 V output for sensor supply (max. 100 mA) <sup>1</sup>
	12V-Out	12 V output for sensor supply (max. 200 mA) <sup>2</sup>
X22	AGND	Analog ground
	AN2	Analog input 2
	5V-Out	5 V output for sensor supply (max. 100 mA) <sup>1</sup>
	12V-Out	12 V output for sensor supply (max. 200 mA) <sup>2</sup>
X9	AGND	Analog ground
	AN3	Analog input 3
	5V-Out	5 V output for sensor supply (max. 100 mA) <sup>1</sup>
	12V-Out	12 V output for sensor supply (max. 200 mA) <sup>2</sup>
X11	CurrL	Differential current input (-)
	VL	Differential voltage input (-)
	AN4 / VH	Differential voltage input (+)
	CurrH	Differential current input (+)
X20	12Vbat OUT	12 V power supply (max. 500 mA) <sup>3</sup>
	12Vbat OUT	12 V power supply (max. 500 mA) <sup>3</sup>
	12Vbat OUT	12 V power supply (max. 500 mA) <sup>3</sup>
	GND	Ground

<sup>2</sup> 200 mA total current for all sensors

<sup>3</sup> 1 A total current for all 12Vbat OUT

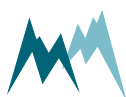

Group	Pin	Description
X21	SW1	switching output 1 (supply voltage, max. 0.5 A @ 12 V)
	SW2	switching output 2 (supply voltage, max. 0.5 A @ 12 V)
	SW3	switching output 3 (supply voltage, max. 0.5 A @ 12 V)
	GND	Ground

## 7.2 Ethernet

The MRL-8P can be connected directly to a router with a RJ45 cable. Optionally, the router can be powered via the MRL-8P by connecting it to one of the switched power supplies on terminal X21. The supply can be selected in [Power ext. LAN](#).



**NOTE** By default the internal Ethernet module is powered by one of the switched voltage outputs on port X21. If non of these outputs is available, it can be powered by one of the continuous voltage outputs of port X20. In this case it is recommended to set [X20 reset](#) to 10 sec or 30 sec to provide a daily reboot of the Ethernet module. Keep in mind that permanently powering the Ethernet module considerably increases power consumption.

See [Operation](#) and [Ethernet connection](#) for different tasks related to Ethernet communication.

## 8 Installation

### 8.1 Where should I install the MRL-8P?

The MRL-8P has been designed for applications in harsh environments. With its IP-67 protection rating it can be installed directly at the measurement facility.

If additional control and acquisition devices are used, the MRL-8P may also be mounted in a suitably sized cabinet.



**ATTENTION** If the MRL-8P is installed outdoors, make sure the device cover and cable glands are tightened firmly and that unused glands are replaced with watertight blanking plugs (see accessories list in [Unpacking](#)).

### 8.2 How do I install the MRL-8P?

#### 8.2.1 Mounting

The MRL-8P can be mounted to a mounting plate of an electrical cabinet or any other back-plate with four M5 cylinder head screws with hexagon or torx socket or M4 cylinder head screws with simple or cross slot. The mounting holes can be accessed by removing the cover strips on both sides of the MRL-8P (see figure below).



## 8.2.2 Power supply

The MRL-8P is designed for power saving applications where mains power is not available. In idle mode the data logger consumes less than 0.6 mA at 12 VDC. This can increase considerably if the MRL-8P needs to supply connected sensors, if short measurement intervals are required or if the communication modem is active.

The MRL-8P can be powered with a 9...28 VDC power supply connected to the + Solar/- Solar of terminal X2 if mains power is available at the monitoring site. Alternatively, the MRL-8P can be solar powered as described in [Solar power](#). Note that consumption increases if the MRL-8P is powered via the charger.

### 8.2.2.1 Solar power

An integrated solar charger allows the MRL-8P to be powered by solar energy. The charger can regulate a solar panel power up to 40 W at 12 V.



**ATTENTION** The power input of the MRL-8P is equipped with a 2-A fuse. In case the equipment of your monitoring station consumes more than 2 A, you need to use an external solar charger.

Follow the steps below to assemble a solar powered data logger unit:

1. Prepare appropriately dimensioned wires for connecting the solar panel and battery. For cable length up to 5 m, use 1.5-mm<sup>2</sup> copper wire. For longer cable length please consult an expert or SOMMER Messtechnik.
2. Connect a 12 V lead-acid battery with the correct polarity to the data logger. Connect a 10 A fuse to the connecting wire as shown in [Figure](#) below.
3. Connect the solar panel with the correct polarity to data logger.

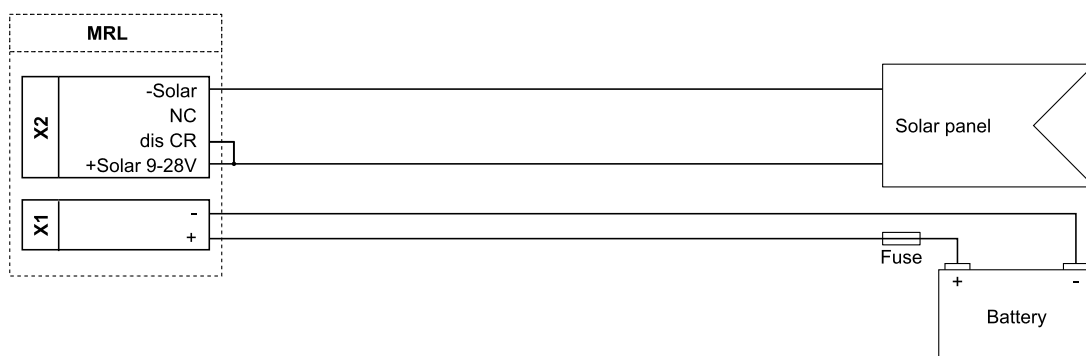

Figure 3 Wiring of a solar panel

### 8.2.3 Signal cables

Please consider the maximum cable lengths for the applied transmission protocol:

Protocol	Max. cable length
SDI-12	~60 m (depending on wire cross section and number of sensors)
RS-485	~300 m



**NOTE** Cable lengths longer than 60 m require a heavier gauge wire if the power supply drops below 11 V.

### 8.2.4 Surge protection

Direct and indirect lightning strikes can damage or destroy the data logger. Carefully selected and designed measurement sites reduce this risk. For proper surge protection please consult the applicable regulations in your country, an expert in lightning protection or SOMMER Messtechnik.

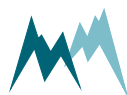





# 9 Operation

## 9.1 How to use the keyboard

### 9.1.1 Keyboard buttons

The keyboard on the data logger can be used to view data and to configure a range of settings. The keys have the following navigation functions:

	Exit the current menu / abort
	Move down the menu list / decrease value
	Move up the menu list / increase value
	Select a menu item / confirm / trigger measurement
	Searching USB stick / connect Bluetooth / special functions

If a Bluetooth connection is active, the message *BT active no access!* is displayed and any manual access to the data logger is denied.



**ATTENTION** Pressing  aborts any activity on the logger, e.g. an active Bluetooth connection, modem test mode or data download to USB.

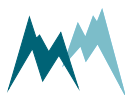

## 9.1.2 Display menu

The settings and data that can be accessed by the keyboard on the data logger. The table below lists the structure of the display menu.

Start screen	Displays the station number, date and time.
* Measurements *	Menu containing the latest measurements of the variables specified in <a href="#">Measurement table</a> .
01 ... xx <sup>1</sup>	Variables 1 ... xx <sup>1</sup>
*** Stored V ***	Menu containing the stored measurements of the variables specified in <a href="#">Measurement table</a> .
01 ... xx <sup>1</sup>	Variables 1 ... xx <sup>1</sup>
*** Settings ***	Settings as described in <a href="#">Reading and changing a setting</a>
**** Status ****	Status information
1	Station No.
2	SOMMER ID
3	Station name
4	Date
5	Time
6	Software version
7 <sup>2</sup>	IMSI number (only if display is unlocked, i.e., <a href="#">Display access</a> is <i>Off</i> )
8 <sup>2</sup>	State of modem
9 <sup>2</sup>	Type of modem
10 <sup>2</sup>	Mobile signal quality (CSQ)

<sup>1</sup> up to 99 values, depends on [Measurements, max. number](#)

<sup>2</sup> only if modem is active

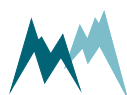

11 <sup>2</sup>	IP address, assigned by mobile operator
12 <sup>2</sup>	International identifier of the currently dialed network (mobile country code (MCC) and mobile network code (MNC))
13 <sup>2</sup>	IP-Call password (only if display is unlocked, i.e., <b>Display access</b> is <i>Off</i> )

Display menu structure



**NOTE** At very low ambient temperatures the LCD Display may react slowly and entered commands may not be visible instantly!

### 9.1.3 Activating the display

Press any key for at least one second. The data logger then displays the station number, current date and time. After four seconds of inactivity the display automatically shows the first measurement variable or an error in case of failure.

### 9.1.4 Switching off the display

The display is automatically switched off if no button is pressed within 10 seconds after activation. Otherwise the display is switched off after one minute of inactivity.

Alternatively, the display can be switched off by pressing  for at least two seconds. *Access and hold key!* is shown and the display is switched off by holding the key.

### 9.1.5 Displaying the latest measurement values







After activating the data logger, press any arrow key to show the value of the first measurement variable. Press the up and down keys to navigate through the measurement list.

Press  to trigger a measurement of the selected variable.

### 9.1.6 Replace and adjust a measurement value

To adjust an automatically recorded value with a measurement acquired manually or with a secondary sensor perform the following steps:



1. Navigate to the required variable as described in [Displaying the latest measurement values](#) above.
2. Hold  for at least two seconds.
3. Enter the access code by pressing 2x  followed by 2x .
4. Adjust the value with  and . Hold the keys to increase/decrease the value more quickly.
5. Confirm with  or abort with .













A measurement value can quickly be adjusted to zero by pressing .



**ATTENTION** As long as the display is active during the ongoing session, the entered access code unlocks all system settings of the data logger!

### 9.1.7 Reading and changing a setting

The settings listed in the table below can be read and changed directly on the data logger by performing the following steps:

1. Press  until you get to the main menu.
2. Navigate to \*\*\* Settings \*\*\* with  and  and press .
3. Enter the access code by pressing 2x  followed by 2x .
4. Navigate to the desired setting with  and  and press .
5. Adjust the value with  and . Hold the keys to increase/decrease the value more quickly.
6. Confirm with  or abort with .

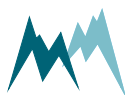

Setting	Example Value	Description
Station No.	20160111	Station number
Date	06.04.2017	Current date
Time	09:26:28	Current time
Exposure lock	off	Access to measurement values
Copy all data	-	Copies all internally stored data to a USB flash drive
Erase all data	-	Erases all stored data
Continuous M	turn on	Continuous Measurement
Adjust Contrast	weak	Adjusts the display contrast
Reboot Device	-	Reboots the MRL-8P
Modem Test-mode	-	Tests the internal mobile modem or Ethernet connection. Only available if a modem or Ethernet connection is configured.
Sat Modem Testmo	-	Tests the external satellite modem for serial communication and satellite connectivity; sends the currently active data setup header to the server.

#### Accessible settings

#### Exposure lock (display access)

Controls the access to measurement data. See [Display access](#) for details.

#### Copy all data

Copies all stored data to a connected USB flash drive.

#### Erase all data

Deletes all measurement data from the data logger.



**ATTENTION** Use with caution! Erased data cannot be retrieved!

#### Continuous M

Activates a continuous monitoring mode in which measurements are performed in the shortest possible interval. This mode is intended for testing purposes and is automatically deactivated after three minutes. Note, that not every sensor measurement can be triggered by the MRL-8P.

#### Adjust Contrast

Adjusts the brightness of the LCD-display in four levels: base, weak, medium and high.

## Reboot Device

Reboots the data logger without the need to switch the power supply, e.g. before firmware update.

## Modem Testmode

Performs a modem test that includes the following tasks:

- Initialization of the modem.
- The signal strength of the mobile network is tested and displayed.
- The defined mobile communication actions are carried out (time synchronization, data transfer to FTP or HTTP server, activation of IP-Call function).

## 9.2 How to open the data logger housing

The data logger has a waterproof design which requires the sensors and SIM card to be connected internally.



**ATTENTION** To avoid any damage disconnect the power supply before opening the housing!

To open the housing remove the cover strips on both sides of the data logger and loosen the four bolts with a Philips or flat-head screwdriver. Then, remove the lid by turning it carefully upside down. Be careful not to strain any signal wires.

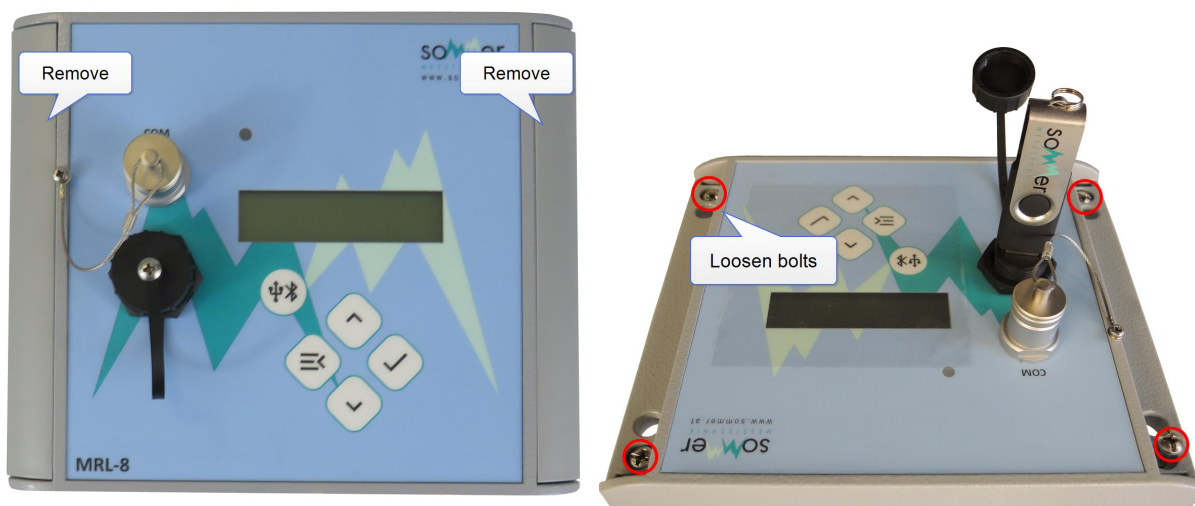

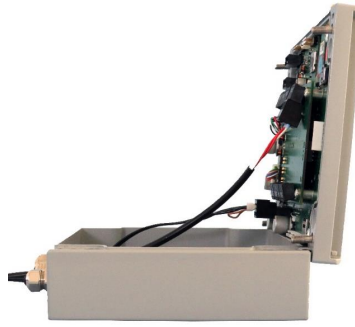

Figure 4 Open the MRL-8P housing



#### ATTENTION

Before closing the data logger make sure that the rubber seal is not broken and firmly sitting in its groove!

When closing, tighten diagonally positioned screws step by step!

## 9.3 How to use the spring clips

To connect a sensor to the MRL-8P, 2- or 4-pin spring clips as shown in [Figure 5](#) are used.

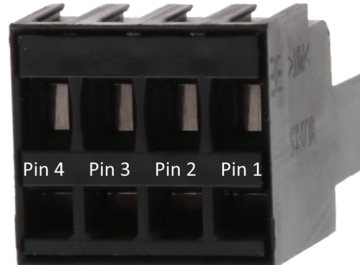
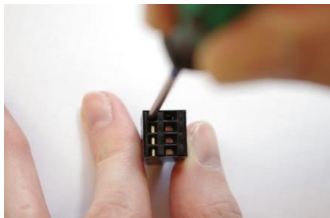
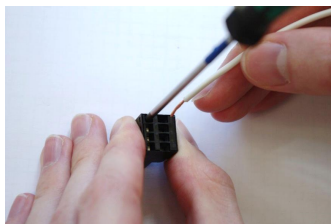

Figure 5 4-pin spring clip

After removing the spring clip from the data logger, the sensor wires are connected in the following way:



Push a 2-mm flat-head screwdriver into the spring slot to open the connection terminal.



Insert the wire into the connection terminal.

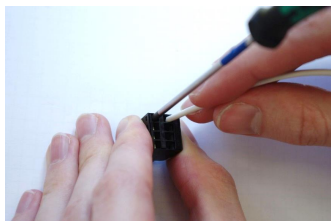

Make sure the wire is inserted down to the bottom of the connection terminal.



**ATTENTION** Make sure the spring clip connects on the bare wire and not on the wire insulation!

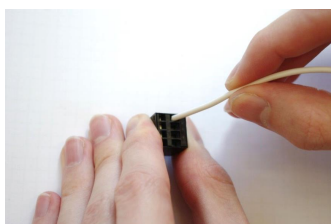

Pull out the screwdriver and verify that the wire is fixed firmly.

## 9.4 How to connect a sensor

To connect a sensor to the MRL-8P follow the steps described below:

1. Open the housing as describes in [How to open the data logger housing](#)  
Feed the sensor cable through the cable gland.
2. Strip 10 ... 20 cm of the cable insulation. The insulated cable should protrude max. 1 cm into the housing.

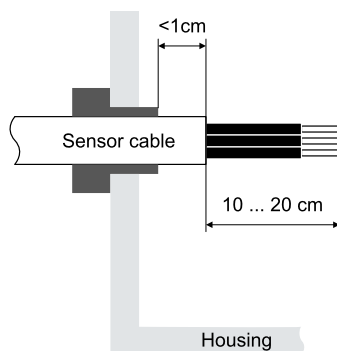

3. Connect the cable wires to the specified terminals (see [Terminals](#)). For handling the spring clips see [How to use the spring clips](#).
4. After closing the data logger, carefully tighten the cable glands.

## 9.5 How to set the clock

The time of the MRL-8P can also be synchronized manually by clicking [Set device time](#) in the Commander [Parameters \(F2\)](#) tab.



**ATTENTION** If the internal lithium button cell battery is replaced, the current device time is lost and needs to be re-synchronized!

## 9.6 How to copy data to a USB flash drive









### 9.6.1 Copy data since last download

1. Insert a USB flash drive into the USB port of the MRL-8P.
2. Activate the data logger.
3. Press . Display shows *transfer running* and data are now copied to the USB flash drive.



**NOTE** Press  for more than 25 seconds that the MRL-8P will start searching for a Bluetooth receiver instead of copying the new data to the USB flash drive.

### 9.6.2 Copy all data

1. Activate the data logger.
2. Press  until you get to the main menu.
3. Navigate to `*** Settings ***` with  and  and press .
4. Enter the access code by pressing 2x  followed by 2x .
5. Navigate to `Copy all data` with  and  and press . The data are now copied to the USB flash drive as a csv-file in the SommerXF format. The data can then be viewed with the Commander. Alternatively, open the downloaded data file with a text editor or import it into a spreadsheet application like Microsoft Excel.

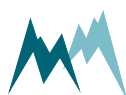

## 9.7 How to insert the SIM card

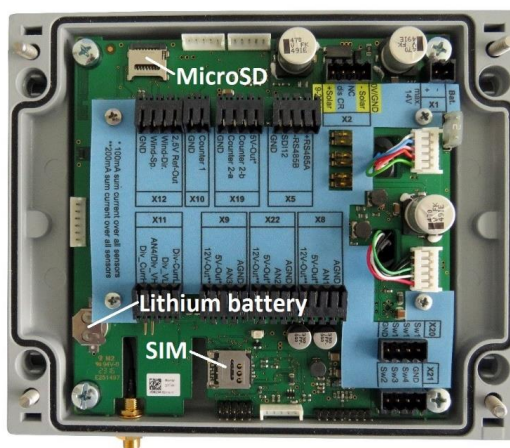
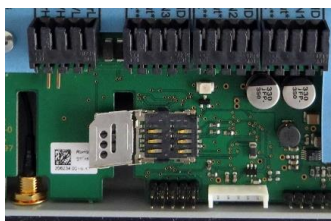

Figure 6 Slots for SIM-card, MicroSD-card and lithium battery

The location of the SIM-card slot is shown in Figure 6. The slot only accepts Micro-SIM cards.



To insert a SIM-card open the housing as described in section [How to open the data logger housing](#) and unlock the card-slot by pressing gently on the metal cover and sliding it slightly to the left. A faint click is audible.



Open the cover of the slot.



Place the SIM-card in the correct position onto the contact pins.



**ATTENTION** Insert the SIM-card in the position as shown in the image! The trimmed corner of the card must match the raised corner of the slot.

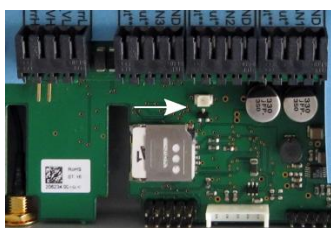

Close the cover and slide it back into the locked position.

## 9.8 How to activate mobile communication

For remote communication with the MRL-8P and regular data transmission, mobile communication needs to be activated. Follow the steps below for configuration:



**ATTENTION** Make sure your SIM card is activated, your mobile data contract is valid and your data credit is sufficient!



**TIP** Deactivate the SIM-pin with your mobile phone!

1. Insert the SIM card as described in [How to insert the SIM card](#).
2. Connect an antenna to the MRL-8P.
3. Power the MRL-8P, connect it to Commander and download the parameter file (see [RS-232 using a USB converter](#) for details).
4. In the menu **Network** set **Operation** to *on*.
5. Enter the pin of your SIM card, or *-1* if you have deactivated the SIM-pin.
6. Enter the APN information in the menu **Modem config**. This information is available from the Commander menu shown below or your mobile provider.



**TIP**

Click **Select APN** in the **Special commands** section of the Commander and select the APN information of your provider!

MCC	Country	Provider	APN	User	Password
231	Slovakia	Orange World	orangewap	wap	wap
231	Slovakia	T-Mobile internet	internet		
231	Slovakia	O2 internet	o2internet		
232	Austria	live!	a1.net	ppp@a1plus.at	ppp
232	Austria	T-Mobile LTE	internet.t-mobile.at	t-mobile	tm
232	Austria	Planet 3	drei.at		
232	Austria	tele.ring web	web	web@telering.at	web
232	Austria	Planet3	drei.at		
232	Austria	data.bob	bob.at	data@bob.at	ppp
232	Austria	yesss!	web.yesss.at		
234	United Kingd	UBIQUISYS	internet		
234	United Kingd	O2 MOBILE WEB	mobile.o2.co.uk	O2web	O2web
234	United Kingd	BT One Phone Internet	internet.btonephone.cc		



**NOTE** Please note, that some provides do not require a username and password!

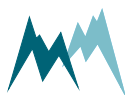



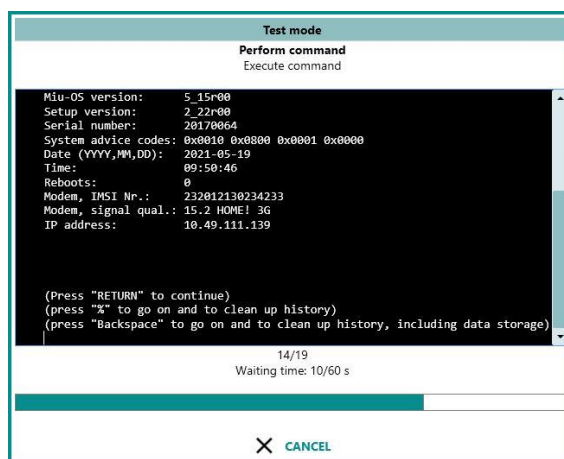





7. In the menu **Remote config** set **Standby, start time** to **00:00:00** and **Standby, duration** to **23:59:50**. This enables permanent access to the MRL-8P.
8. Click **Upload modified parameters to device** to write the settings to the MRL-8P.
9. Wait about one minute until the modem has been initialized.
10. In the menu **Special functions** click **Device status**. If all modem settings are correct the assigned IP-address is displayed in a pop-up window.



## 9.9 How to do a modem test

Follow the instructions below to test communication via modem:

1. Make sure the MRL-8P is powered.
2. Verify that an antenna is connected to the MRL-8P.
3. Verify that the setup parameter **Operation** is set to **on**.
4. Activate the display of the MRL-8P by pressing one of the arrow buttons.
5. Press  until you get to the main menu, i.e. *\*Measurements\**.
6. Navigate to *\*\*\* Settings \*\*\** with  and  and press .
7. Enter the access code by pressing 2x  followed by 2x .
8. Navigate to **Modem Testmode** with  and  and press . The MRL-8P now performs several tests:
  1. The modem is initialized.
  2. The signal strength is displayed.
  3. The configured mobile communication actions are carried out: time synchronization, data transfer to the defined FTP or HTTP servers, activation of IP-Call function.
9. Each action during the test is completed with the display *success* or *failed*. At the end of a successful modem test, the MRL-8P displays *finished*.



### TIP

The function of the modem can also be tested with the MRL-8P connected to the Commander. Click [Device status](#) in the parameter menu [Special functions](#). If the modem has been connected to the mobile network it will display the assigned IP-address and the IP-Call password or IMSI number.

```

Test mode
Perform command
Execute command

Miu-OS version: 5.15r00
Setup version: 2.22r00
Serial number: 20170064
System advice codes: 0x0010 0x0000 0x0001 0x0000
Date (YYYY,MM,DD): 2021-05-19
Time: 09:50:46
Reboots: 0
Modem, IMSI Nr.: 932012130234233
Modem, signal qual.: 15.2 HOME! 3G
IP address: 10.49.111.139

(Press "RETURN" to continue)
(Press "*" to go on and to clean up history)
(Press "Backspace" to go on and to clean up history, including data storage)

14/19
Waiting time: 10/60 s

X CANCEL

```

## 9.10 How to set messages & actions

In the measurement table trigger values can be specified for critical variables. If a limit value is violated the MRL-8P can perform one of the following actions (specified in [Messages, table](#)):

ID	Message	Description
1	Off	No message is sent.
2	Switch	A switch output is closed if a trigger condition is satisfied.
3	E-Mail	An E-mail is sent to a defined recipient if the trigger condition is satisfied.
4	Text	A SMS message is sent to a defined recipient if the trigger condition is satisfied.

Follow the instructions below to configure messages & actions:

1. In the menu [Messages, table](#) select the message type (*switch* or *text*).
2. Enter the recipients mobile number, and the content of the message.

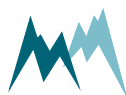

message	Recipient	Subject	Content	Switch	Hold
01	Switch			<input checked="" type="checkbox"/>	10
02	E-mail	monitoring@sommer.at	Wind speed exceeded	<input type="checkbox"/>	
03	text	0041123456789		<input type="checkbox"/>	

If you have selected *Switch*, tick one the switches 01, 02 or 03 (wired on terminal X21) and enter the time in seconds the switch should be active, or enter 0 to stay active as long as the condition stays active.

- Link the messages & actions to the variables in the measurement table by ticking the corresponding *Messages*.

Function	Identifier	Unit	Decimals	Scale	Offset		S-TYP	S-NUM	S-MEA	S-ADD	Limit	Messages
01	actual	Supply	V	as S	0	Adjustment	Test	SYS	0	+Sup V		<input type="checkbox"/>
02	actual	Water level	mm	as S	0	Adjustment	Test	SBP	1	1	1000	<input checked="" type="checkbox"/>
03	actual	Velocity	m/s	as S	0	Adjustment	Test	SBP	1	2		<input type="checkbox"/>
04	actual	Quality (SNR)		as S	0	Adjustment	Test	SBP	1	3		<input type="checkbox"/>
05	actual	Flow	m <sup>3</sup> /h	as S	0	Adjustment	Test	SBP	1	4	ST	<input checked="" type="checkbox"/>
06	sum	Daily flow	m <sup>3</sup>	as S	0	Adjustment	Test	COUNT		Counter 1		<input type="checkbox"/>

As shown in this example one or more messages can be assigned to one or more variables. Thus, messages and actions can be triggered for multiple conditions.

- Enter the threshold values that trigger a message or action. By default a message or action is triggered if the measured value exceeds the threshold. To trigger a message when the measured value falls below the threshold, enter the command *ST* in *S-ADD* as shown above.



**TIP** Messages can contain special commands to provide precise information about the trigger condition. The message `Wind speed at %sname% is %rval% %cunit%!` is received as `Wind speed at AWOS_01 is 31.24 m/s!`. See [Messages, table](#) for a full list of available codes.



**NOTE** Up to 16 actions can be specified and associated with multiple variables.



**ATTENTION** Try to limit your SMS notifications! Each message transmission takes time and if a larger number of notifications has to be sent at once, the MRL-8P may delay or skip transmission.



**TIP** To test a notification or action, define a dummy variable in [Measurement table](#) with *Scale 0* and *Offset 10*, and set a limit value as in the following example.



Function	Identifier	Unit	Decimals	Scale	Offset	S-TYP	S-NUM	S-MEA	S-ADD	Limit	Messages		
01	actual	Test	-	1	0	10	Adjustment	Test	SYS	0	+Bat V	50	<input checked="" type="checkbox"/>

To trigger a message, increase **Offset** to a value above **Limit** and upload the parameter to the MRL-8P. After the next measurement, the notification or action will be triggered.

Delete the dummy variable after you have completed your tests.

## 9.11 How to enable e-mail

Follow the instructions below to enable messages by e-mail as described in [How to set messages & actions](#):

1. Obtain the settings for the e-mail account you want to use or create a new account, e.g. Google Mail.
2. Enter the account information in the menu **E-mail/SMTP** as in the following example.



### EXAMPLE

#### E-mail/SMTP settings for a Google Mail account

E-mail/SMTP	smtp.gmail.com
Sender	nachrichten.sommer@gmail.com
Username	nachrichten.sommer@gmail.com
Password	*****
Port	587
SSL/TLS	On (if SSL encryption is required)



**NOTE** Sommer Messtechnik does not provide e-mail services! Please contact your IT department to setup an e-mail account, or create your own account with an online-provider, e.g. Google,...



**NOTE** Check with your service provider if SSL encryption is required!

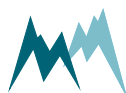

## 9.12 How to enable remote access

The Commander software communicates with a remote MRL-8P via **IP-Call**<sup>1</sup> or socket connection (mobile connection) or Ethernet. For applications that require redundancy, remote access can be enabled by both, Ethernet and mobile connection.

Follow the steps below to enable remote communication:

1. Activate Ethernet and/or mobile communication as described in [How to activate Ethernet communication](#) and [How to activate mobile communication](#).
2. Enter an arbitrary **IP Call password** (alphanumeric string, 15 characters long) in menu [Remote config](#)
3. Set one or two time windows during which you want to be able to connect to the MRL-8P. Using restricted time windows is recommended to reduce power consumption.



### EXAMPLE

#### Two time windows using mobile communication

To save power set one or two short time windows, e.g. one in the morning, the other in the afternoon.

Time window 1		Time window 2	
Connection	IP Call	Connection	IP Call
Access	Modem	Access	Modem
Standby, start time	08:00:00	Standby, start time	16:00:00
Standby, duration	00:30:00	Standby, duration	00:30:00
IP Call server	mds.sommer.at	IP Call server	mds.sommer.at
IP Call port	4647	IP Call port	4647
IP Call interval	00:01:00	IP Call interval	00:01:00



### EXAMPLE

#### Two time windows using redundant mobile and Ethernet communication

Using both communication options will provide redundancy.

<sup>1</sup>A technology that provides communication services over the Internet.



Time window 1		Time window 2	
Connection	IP Call	Connection	Socket
Access	Modem	Access	Ethernet
Standby, start time	08:00:00	Standby, start time	16:00:00
Standby, duration	00:30:00	Standby, duration	00:30:00
IP Call server	mds.sommer.at	IP Call server	-
IP Call port	4647	IP Call port	-
IP Call interval	00:01:00	IP Call interval	-



### EXAMPLE

#### Permanent access

If your MRL-8P is powered from the grid, you may set the time window for permanent access:

Time window 1		Time window 2	
Connection	IP Call	Connection	Off
Access	Modem	Access	-
Standby, start time	00:00:00	Standby, start time	-
Standby, duration	23:59:50	Standby, duration	-
IP Call server	mds.sommer.at	IP Call server	-
IP Call port	4647	IP Call port	-
IP Call interval	00:01:00	IP Call interval	-



**NOTE** The IP-Call settings above refer to the switch server of Sommer Messtechnik, the use of which is provided as a service to our customers. Although we try to run the server permanently, we cannot guarantee uninterrupted service. You may consider to purchase your own switch server and MDS (measurement data server).

## 9.13 How to activate Ethernet communication

For remote communication and regular data transmission via Ethernet, the Ethernet module (MEE) of the MRL-8P must be activated.



### ATTENTION

Ethernet communication of a newly shipped MRL-8P is not activated !

Follow the instructions below to activate Ethernet communication:

1. Open the MRL-8P as described in section [How to open the data logger housing](#).
2. Set the MRL-8P to power the Ethernet module permanently by moving the plug on terminal X21 to terminal X20.
3. Connect the MRL-8P with an RJ45 patch cable to your PC.
4. Connect a 9...28 VDC supply to terminal X2.
5. Adapt the Ethernet settings of your PC by following the steps below:
  - a. Enter the Windows control panel by pressing the Windows-key and typing *control panel*.
  - b. Select [Network and Sharing center](#).
  - c. Click [Change adapter settings](#).
  - d. Double-click the Ethernet adapter used by your PC, e.g. *Ethernet0*.
  - e. In the pop-up window click on [Properties](#).
  - f. In the list of the Networking double-click on [Internet Protocol Version 4 \(TCP/IPv4\)](#)
  - g. Enter the settings as shown below.

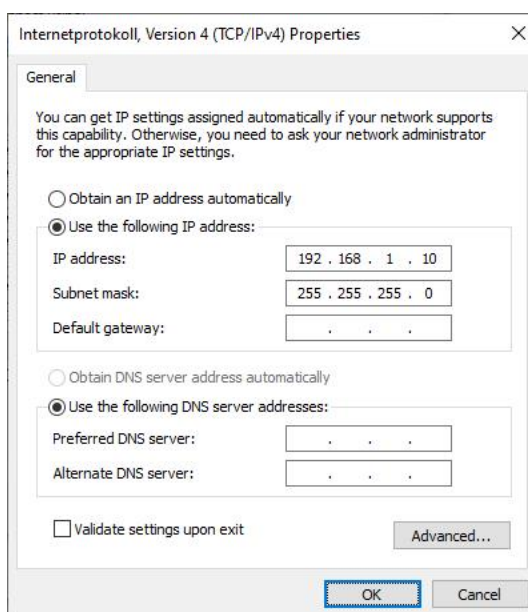

The last byte of the IP-address can take a value between **1** and **254**, except **99**, which is taken by the MRL-8P; **1** should be avoided.

- h. Click **OK** to save the new settings.

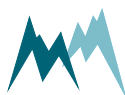

6. Open your internet browser and connect to the MRL-8P by entering the IP-address of the device in a web browser. The default IP address of the MRL-8P is 192.168.1.99 and the respective URL is <http://192.168.1.99/index.htm>. After successful connection, the following start screen appears:

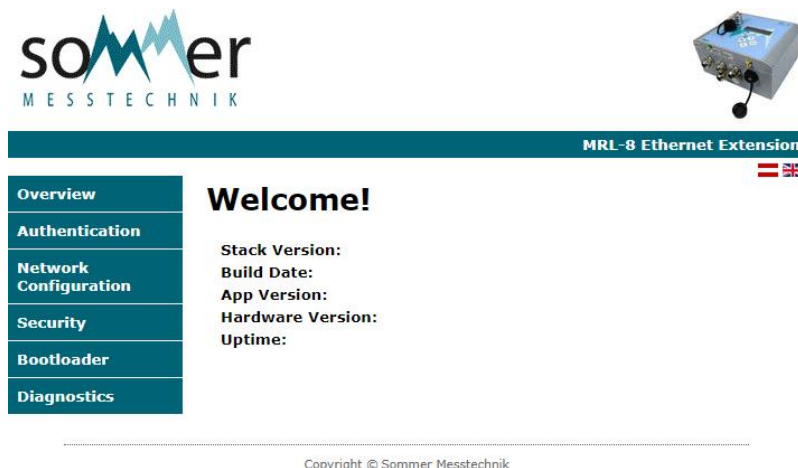

**sommer**  
MESSTECHNIK

MRL-8 Ethernet Extension

Overview  
Authentication  
Network Configuration  
Security  
Bootloader  
Diagnostics

## Welcome!

Stack Version:  
Build Date:  
App Version:  
Hardware Version:  
Uptime:

Copyright © Sommer Messtechnik

7. To edit the network settings click [Network Configuration](#) and enter your login credentials. The default username is *admin* and the default password is *sommer*. After successful login the network settings are displayed:

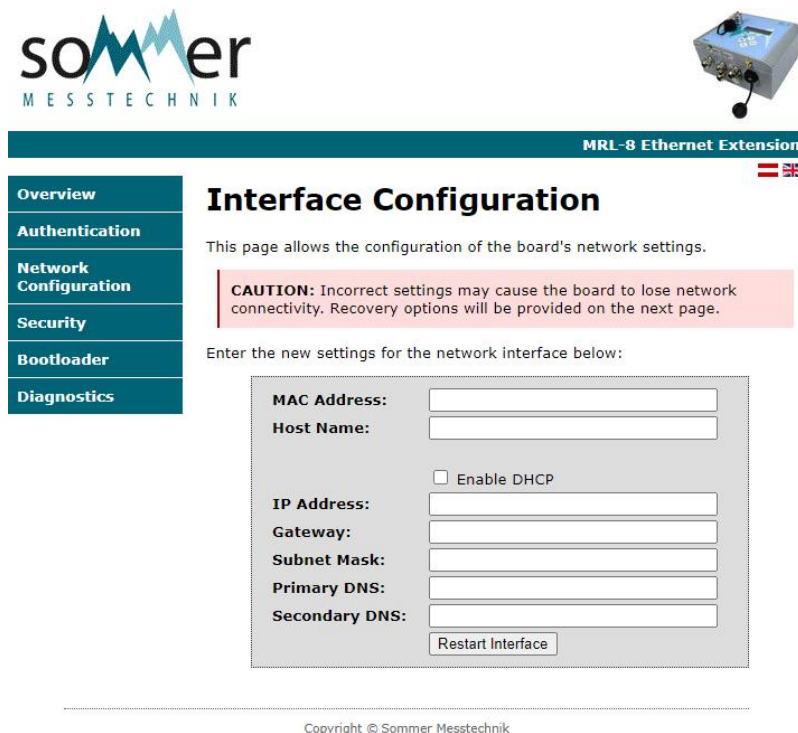

**sommer**  
MESSTECHNIK

MRL-8 Ethernet Extension

Overview  
Authentication  
Network Configuration  
Security  
Bootloader  
Diagnostics

## Interface Configuration

This page allows the configuration of the board's network settings.

**CAUTION:** Incorrect settings may cause the board to lose network connectivity. Recovery options will be provided on the next page.

Enter the new settings for the network interface below:

MAC Address:   
Host Name:

Enable DHCP

IP Address:   
Gateway:   
Subnet Mask:   
Primary DNS:   
Secondary DNS:

Copyright © Sommer Messtechnik

8. The following settings can be adapted to your needs:

**MAC address**

The MAC address is a unique identifier for any network device and is automatically read from the internal Ethernet module.

**Host name**

The name of MRL-8P in the network; should be a unique string with max. 16 characters. Default is *MEE*.

**Enable DHCP**

Activate this option for automatic assignment of an IP address to the MRL-8P. The following IP settings of the MRL-8P are adjustable:

**IP Address:**

Default is *192.168.1.99*

**Gateway:**

Default is *192.168.1.1*

**Subnet Mask:**

Default is *255.255.255.0*

**Primary DNS:**

Default is *192.168.1.1*

**Secondary DNS:**

Default is *0.0.0.0*

**TIP**

Contact your IT department or IT service provider if you don't know how to set your IP settings.

9. Click [Restart Interface](#) to activate the new settings.

**ATTENTION**

Incorrect settings may cause the MRL-8P to lose network connectivity. If you cannot connect to the MRL-8P anymore, open the data logger and reset the Ethernet module. This will reset the network settings and login data to its default values.

To reset the Ethernet module follow the steps below:

1. Remove the power supply from the MRL-8P
2. Press the button ETHERNET RESET on the Ethernet module (next to the on-board lithium battery)
3. Re-power the MRL-8P
4. Release the button ETHERNET RESET

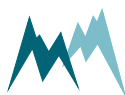

10. Optionally, set your MRL-8P to use SSL for Web-User-Interface by selecting **Security** and ticking **Website uses SSL**. Click **Change** to activate this setting.

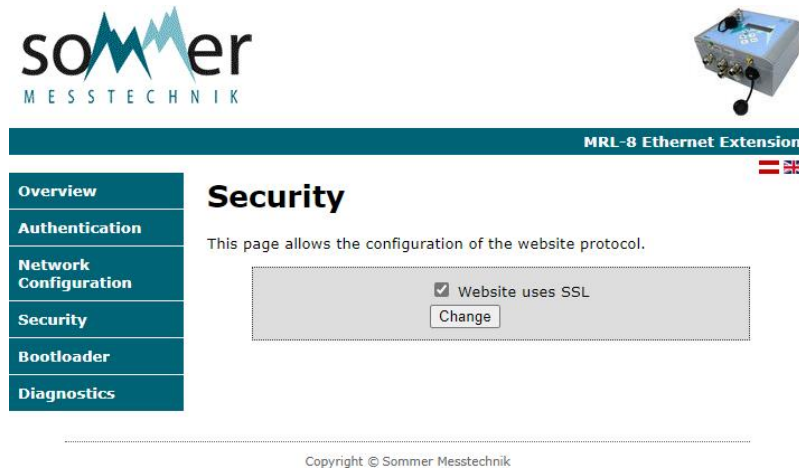

11. To test Ethernet communication with the MRL-8P please configure remote access as described in [How to enable remote access](#) and choose **Socket connection** with a time window covering your current daytime.  
If you do not wish to test the communication please skip the next point.
12. If you have configured remote access as described in point 11, you can test the Ethernet-communication between the MRL-8P and the Commander by following the procedure described in [Ethernet connection](#).
13. Once you have finished the communication test,
- disconnect the MRL-8P from your PC,
  - move the power supply plug from terminal X20 back to terminal X21,
  - restore the Ethernet adapter settings of your PC (see point 5 above).



**NOTE** Remember to shorten remote access to reduce power consumption. See [How to enable remote access](#) for details.

## 9.14 How to configure data transmission via Ethernet

Follow the instructions below to configure the MRL-8P for data transmission via Ethernet:

- Connect to the MRL-8P as described in [Communication with the MRL-8P](#).
- Download the parameters of the MRL-8P.
- Switch **Operation** in menu **Network** to **On**.
- In the sub-menu **Ethernet config** of menu **Network** set the following parameters:

Parameter	Value
Power ext. LAN	Set to <i>SW 02</i> or <i>SW 03</i> to supply an external Ethernet communication device, e.g. router, modem Set to <i>Off</i> if no external Ethernet device needs to be powered.
Warm-up ext. LAN	60 s (default, adapt to the requirements of your router, modem, etc.)
Power MEE	SW 01
Warm-up MEE	15 s
TCP timeout	1000 ms

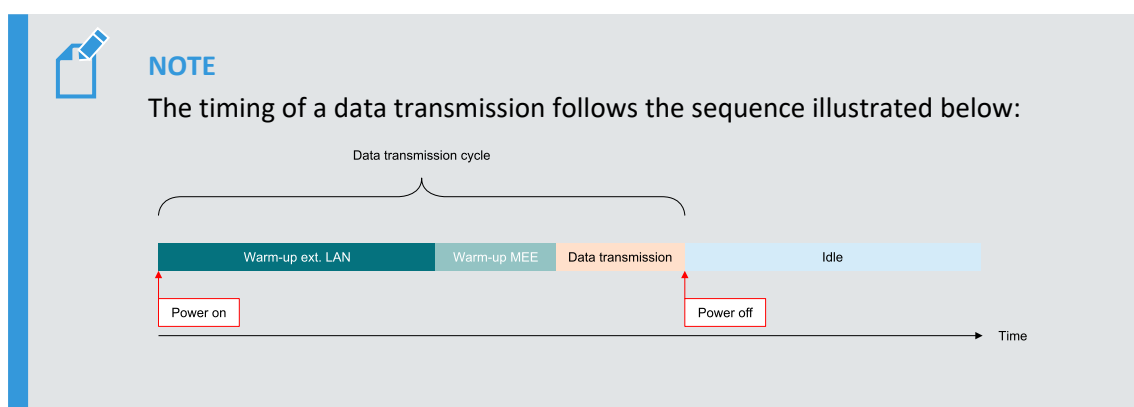

- If Ethernet is used for data transmission, select one of the **Data transmission** menus and set **Target server type** to *FTP(S)* or *HTTP(S)*, and **Access** to *Ethernet*.
- Enter the additional FTP(S) or HTTP(S) settings and set an appropriate **Data transmission interval**.
- Click **Upload modified parameters to device** to write the settings to the MRL-8P.

## 9.15 How to implement external protocol

### ■ Listen to continuous output

If a device sends continuously data values the MRL-8P will keep watch for a resemblance and then try to parse the content according to the configuration. In every configuration you will need either a **Length** and **Start chars / Stop chars** or **Start chars** and **Stop chars** to recognize a protocol. For slowly acting devices or long data packages, it may be necessary to have a longer **Recv timeout** until the last data has been received than for short data packages. Once the package has been received the values can be parsed either by their position in the text or by the number of separator characters that come before it. For a protocol with separator character the **Function** has to be set to **Separator** and a separator character (**Separator**) has to be set. For a protocol with fixed positions of values (**Pos. separ.**) the **Function** has to be set to **Position** and you need to specify start position and length of up to 20 values.

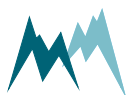

- Trigger measurement response

For better control over the RS-485 bus traffic it is suggested, where possible, to use a triggered data output of devices. If the connected device supports triggering by a specific invariable text, it can be entered into the **Polling chars** field and will be sent at start of every measurement.



**NOTE** Every **Ext. Protocol (EXT)1** offers a "Test"-mode that starts listening for and immediately triggers data packages and you can see which values the current configuration would extract.



### EXAMPLE

**Ext. Protocol (EXT)1** to Trigger Data from a Sommer Messtechnik Sensor; Position based

Parameter	Value	Comment
Function	Position	Define a protocol with separator character
Start chars	23 4D (the spaces are only for visibility)	Characters, the data package of the answer begins with: #M
Stop chars	3B	Character, the data package of the answer ends with: ;
Polling chars	23 54 30 30 30 31 24 70 74 7C 41 35 39 42 3B (the spaces are only for visibility)	Characters used to trigger an output: #T0001\$pt A59B;
Length	250	The maximum length a data string may have; set to high value when <b>Start chars</b> and <b>Stop chars</b> are used

With this trigger the device would answer something like this:

```
#M0001G00se01 30.27|02 2444|03 0|CAE1;
```

To be able to import the value into the MRL-8P the values of interest must be configured. The parameter of the starting position is defined by the number of characters from the start of the data package starting with 1, skipping the specific **Start chars** if present.

Values	Start position	Length
Measurement value 1	12	8
Measurement value 2	23	8
Measurement value 3	34	8



That leads to an entry in the [Measurement table](#):

Parameter	Value	Comment
S-TYP	EXT	Choose the external protocol type
S-NUM	1	The number of the protocol used; (EXT)1-(EXT)4
S-MEA	1	The index for the value from the position table

For the sample data package from before, the imported value 1 is 30.27, value 2 is 2444 and value 3 is 0.



**NOTE** It is strongly advised to use the Commander software to configure external protocols. There is an Assistant that translates letters to two digit hex codes and has a list of non-printable characters to select from. The Assistant also helps in preparation of the separate values.

## 9.16 How to react to important events

If your measurement site is only interesting at certain events and the rest of the year you want to save data/storage you can make use of the [Sensor add-on \(S-ADD\): "SU"](#).

SU stands for Speed Up and takes action in the [Measurement interval](#) (as opposed to messages, that are evaluated on [Storage interval](#)). SU does always use the current measurement value or the current sum for such limit checks.

When the limit has been violated, the intervals in [Interval accel. \(SU\)](#) will be used. If one interval is already shorter it will retain its value.

As with all limits, the [Min. Hold on message](#) has to be taken into account before the Speed Up mode can be finished after the measurement value returns into normal range.



### EXAMPLE

The following parameters need to be adjusted:

Parameter	Value	Comment
Measurement interval	00:15:00	Normal measurement every 15 minutes
Storage interval	01:00:00	Normal storage every hour

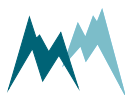



### A variable in Measurement table

Parameter	Value	Comment
Water level	S-ADD entry SU	limit of 50

### Data transmission 1

Parameter	Value	Comment
Data transmission interval	02:00:00	Transmit data every two hours; data file will contain two data lines

### Entries in Interval accel. (SU)

Parameter	Value	Comment
Measuring and Storage	00:05:00	Shorter interval for measuring and storage
Datatransmission	00:10:00	Shorter interval between data transmissions
Picture release	00:10:00	Shorter interval for new pictures of the site

Now, whenever the measured water level rises over 50, following changes take place:

- Immediate triggering of all active transmissions
- All measurements will take place every 5 minutes as opposed to every 15 minutes
- Storage will take place every 5 minutes also to have a fine resolution of the event
- The data transmission will take place every 10 minutes so you can observe the event on your data platform with low delay
- If the site had a camera, that transmission would also be every 10 minutes



**NOTE** After the limit violation has ended all the intervals are set back to the “normal” values.

## 9.17 How to set up data transmission targets

To enable scheduled data transmission, an HTTP or FTP server has to be specified in at least one of four available server configurations ([Data transmission 1](#), [Data transmission 2](#), [Data transmission 3](#) or [Data transmission 4](#)). By default, the *Measurement Data Server* (MDS) of SOMMER Messtechnik is configured. If you have subscribed to this service, you can access the transmitted data on the server's webpage.

Follow the steps below to set up regular data transmission:

1. Activate Ethernet and/or mobile communication as described in [How to activate Ethernet communication](#) and [How to activate mobile communication](#).
2. Set the parameters in the [Data transmission](#) menus as in the following examples:

 **EXAMPLE**  
**Data transmission to an FTP server using mobile communication**

Parameter	Value	Comment
Target server type	FTP	Use FTPS if SSL/TLS encryption is desired, and if server supports it
Access	Modem	
Data transmission interval	00:30:00	Every 30 minutes
Data transmission offset	00:00:17	Random offset to avoid transmission conflicts to the server
Content	Data	Optional: camera to transfer images
FTP server name	ftp.myserver.at	
FTP user name	myuser	
FTP password	mypassword	
FTP directory		An optional sub-directory, e.g. <i>/data</i>
FTP port	21	
FTP mode	Passive	Determined by the mobile service provider if server supports it

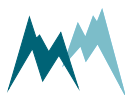

**EXAMPLE****Data transmission to an HTTP server using Ethernet communication**

Parameter	Value	Comment
Target server type	HTTP	Use HTTPS if SSL/TLS encryption is desired, and if server supports it
Access	Modem	
Data transmission interval	00:10:00	Every 10 minutes
Data transmission offset	00:00:31	Random offset to avoid transmission conflicts
Content	Data	Optional: <i>camera</i> to transfer images
HTTP server name	mds.sommer.at	
HTTP basic authentication	On or Off	Set to <i>On</i> if authentication is required.
HTTP basic user name	myuser	Only if authentication is required
HTTP basic password	mypassword	Only if authentication is required
HTTP path	/Web-Service/sommerDaten.php	The data destination.
HTTP port	80	



**NOTE** At each interval, data since the last successful transmission are sent to the server. A copy of the data remains on the data logger until overwritten by newer data.



**NOTE** If measurement data and camera images need to be transmitted, two separate data transmission tasks need to be configured.

## 9.18 How to set messages & actions

In the measurement table trigger values can be specified for critical variables. If a limit value is violated the MRL-8P can perform one of the following actions (specified in [Messages, table](#)):

ID	Message	Description
1	Off	No message is sent.
2	Switch	A switch output is closed if a trigger condition is satisfied.
3	E-Mail	An E-mail is sent to a defined recipient if the trigger condition is satisfied.
4	Text	A SMS message is sent to a defined recipient if the trigger condition is satisfied.

Follow the instructions below to configure messages & actions:

1. In the menu [Messages, table](#) select the message type (*switch* or *text*).
2. Enter the recipients mobile number, and the content of the message.

message	Recipient	Subject	Content	Switch	Hold
				<input type="checkbox"/>	sec
01	Switch			<input checked="" type="checkbox"/>	10
02	E-mail	monitoring@sommer.at	Wind speed exceeded		
03	text	0041123456789	Wind speed at %sname% is %rval% %cunit%!		

If you have selected *Switch*, tick one the switches 01, 02 or 03 (wired on terminal X21) and enter the time in seconds the switch should be active, or enter 0 to stay active as long as the condition stays active.

3. Link the messages & actions to the variables in the measurement table by ticking the corresponding [Messages](#).

Function	Identifier	Unit	Decimals	Scale	Offset	S-TYP	S-NUM	S-MEA	S-ADD	Limit	Messages		
											<input type="checkbox"/>		
01	actual	Supply	V	as S	0	Adjustment	Test	SYS	0	+Sup V	<input type="checkbox"/>		
02	actual	Water level	mm	as S	0	Adjustment	Test	SBP	1	1	1000	<input checked="" type="checkbox"/>	
03	actual	Velocity	m/s	as S	0	Adjustment	Test	SBP	1	2		<input type="checkbox"/>	
04	actual	Quality (SNR)		as S	0	Adjustment	Test	SBP	1	3		<input type="checkbox"/>	
05	actual	Flow	m <sup>3</sup> /h	as S	0	Adjustment	Test	SBP	1	4	ST	250	<input checked="" type="checkbox"/>
06	sum	Daily flow	m <sup>3</sup>	as S	0	Adjustment	Test	COUNT		Counter 1		<input type="checkbox"/>	

As shown in this example one or more messages can be assigned to one or more variables. Thus, messages and actions can be triggered for multiple conditions.

4. Enter the threshold values that trigger a message or action. By default a message or action is triggered if the measured value exceeds the threshold. To trigger a message when the measured value falls below the threshold, enter the command *ST* in *S-ADD* as shown above.



**TIP** Messages can contain special commands to provide precise information about the trigger condition. The message Wind speed at %sname% is %rval% %cunit%! is received as Wind speed at AWOS\_01 is 31.24 m/s!. See [Messages, table](#) for a full list of available codes.



**NOTE** Up to 16 actions can be specified and associated with multiple variables.



**ATTENTION** Try to limit your SMS notifications! Each message transmission takes time and if a larger number of notifications has to be sent at once, the MRL-8P may delay or skip transmission.



**TIP** To test a notification or action, define a dummy variable in [Measurement table](#) with [Scale 0](#) and [Offset 10](#), and set a limit value as in the following example.

Function	Identifier	Unit	Decimals	Scale	Offset	S-TYP	S-NUM	S-MEA	S-ADD	Limit	Messages			
01	actual	Test	-	1	0	10	Adjustment	Test	SYS	0	+Bat V	50	<input checked="" type="checkbox"/>	<input type="checkbox"/>

To trigger a message, increase [Offset](#) to a value above [Limit](#) and upload the parameter to the MRL-8P. After the next measurement, the notification or action will be triggered.

Delete the dummy variable after you have completed your tests.

## 9.19 How to replace the internal fuse

An internal fuse is mounted next to the X1 power supply terminal to protect the MRL-8P from any power surges or power failure effects.

To replace the fuse, unplug any externally connected power supply and remove the cover of the MRL-8P as described in section [How to open the data logger housing](#). Replace the fuse with a new one of type Littlefuse Mini Series 297, 2A, 32V (available, e.g. from Farnell, order-nr. 9943811).

## 9.20 How to replace the internal lithium battery

The 3V lithium button cell battery of type CR1225 supplies the internal clock if the MRL-8P is not powered. Perform the following steps to replace the battery:

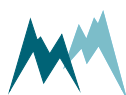

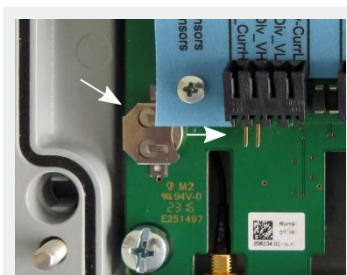

To remove the button cell battery gently push the cell out of its housing from the side using a small screwdriver.

Push the new cell with your fingers from the right side into the housing.

Set the data logger clock according to section [How to set the clock](#).

## 9.21 Data security

The issue of security may arise if the data logger is installed in sensitive areas, the acquired measurements are relevant for the safety of life and property, or intense network traffic bears the risk of data abuse.

To secure your installation and your data we recommend to follow the advice given below:

- Activate the exposure lock on your data logger (see section [Reading and changing a setting](#)).
- To enable secure IP-Call communication, keep the IP-Call password to yourself.

# 10 Maintenance

The MRL-8P does not require any special maintenance other than the occasional replacement of the supply battery of the MRL-8P. The lithium button cell battery lasts approx. 10 years if the MRL-8P is not powered, and generally does not require replacement with a powered device.

## 10.1 Calibration

Re-calibration of the AD-converters strongly depends on the handling of the data logger, its duty time and the demands on accuracy of the acquired measurements. Generally, re-calibration is required after approx. 10 years of operation. Please contact Sommer Messtechnik for this service.

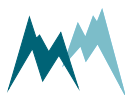

# 11 Support software Commander

## 11.1 Software features

The Commander is a multipurpose software tool to configure and operate any Sommer Messtechnik device. It offers the following functions:

- Communication with Sommer Messtechnik sensors and data loggers via serial connection, modem, socket, IP-call and Bluetooth®
- Management of connections and stations
- Configurations of sensors and data loggers
- Live data monitoring and storage
- Data management including download from data loggers and transmission to MDS (Measurement Data server)
- Terminal window to check data transfer and to access device settings directly

## 11.2 System requirements

The Commander software supports 32- and 64-bit versions of Windows 7 SP1, Windows 8, Windows 8.1, Windows 10 and Windows 11.

For correct operation Microsoft® .NET Framework 4.5 or later must be installed.

## 11.3 Installation of Commander

Follow the steps below to install the Commander software:

1. Plug the USB stick shipped with the device into your PC.
2. Double-click the [commander.msi](#) installer file on the USB drive.

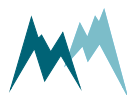

3. Click **Next** on the pop-up window



4. Read the instructions and click **Next**

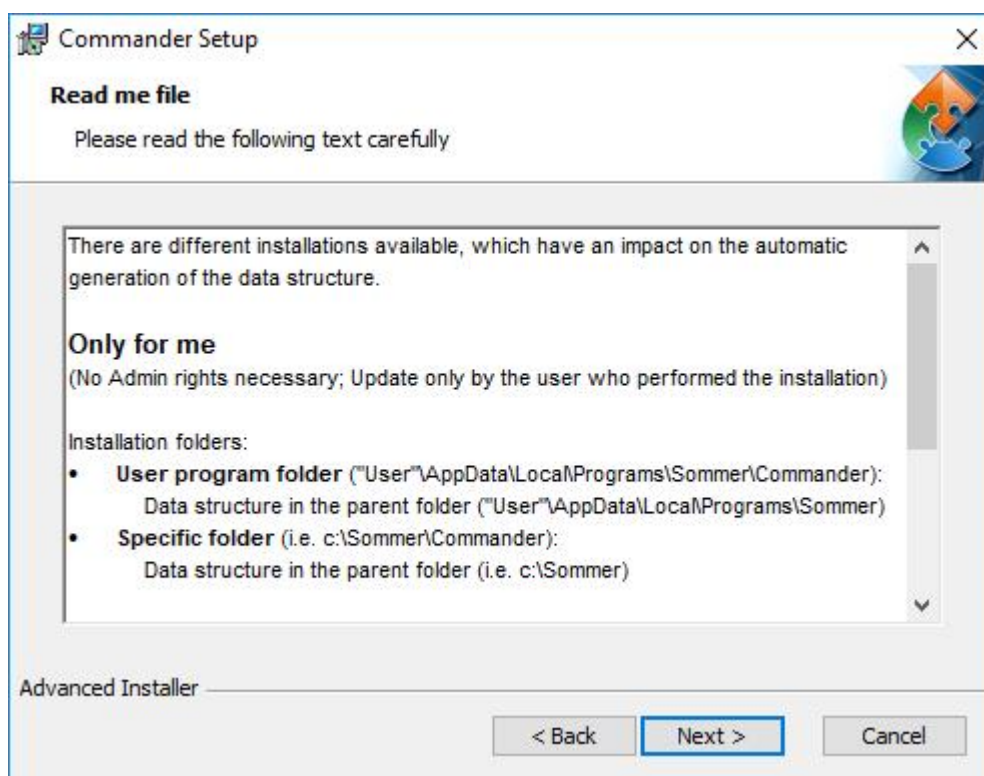

5. Select the installation type and click **Next**

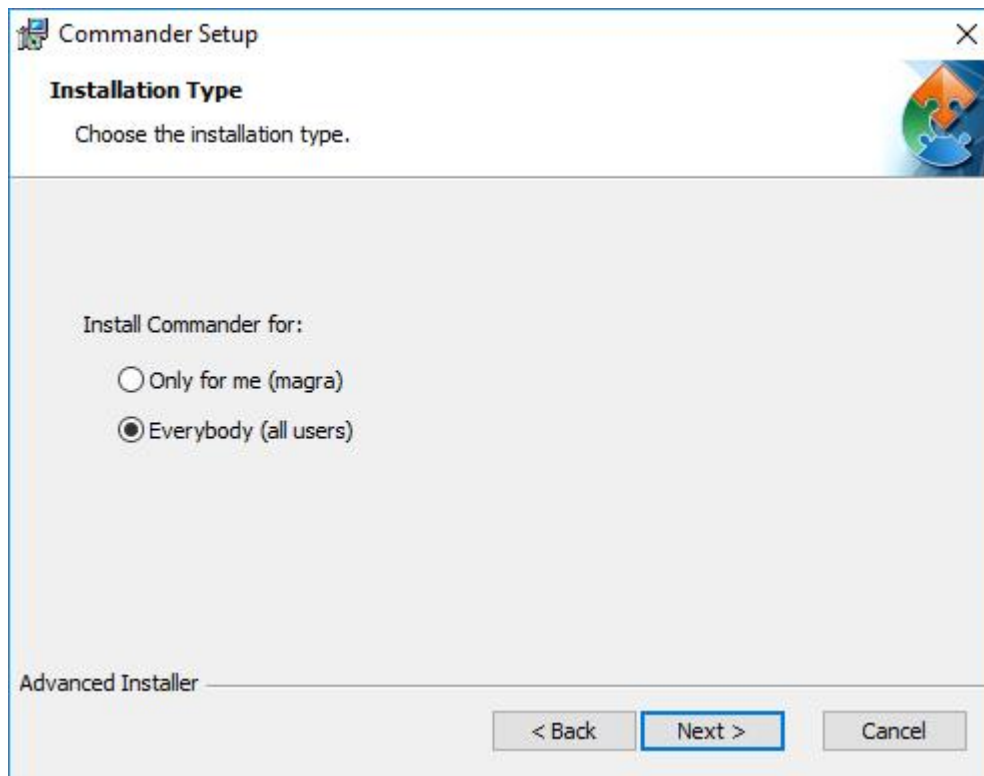

#### NOTE

Two installation types are available. Depending on the selection, the access rights and the folder structure differ:

##### **Only for me**

No admin rights are required. Updates are only available to the user who installed the software.

Installation folders:

- User program folder:  
Users\User\AppData\Local\Programs\Sommer\Commander  
Data structure:  
Users\User\AppData\Local\Programs\Sommer
- Specific folder (default):  
C:\Sommer\Commander  
Data structure (default):  
C:\Sommer





**Everybody**

Admin rights are required. Updates may only be performed by system administrators.

Installation folders:

- Standard program folder:  
Program Files (x86)\Sommer\Commander  
Data structure:  
Users\Public\Public documents\Sommer
- Specific folder (default):  
C:\Sommer\Commander  
Data structure (default):  
C:\Sommer

6. Select the installation directory and click **Next**

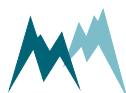
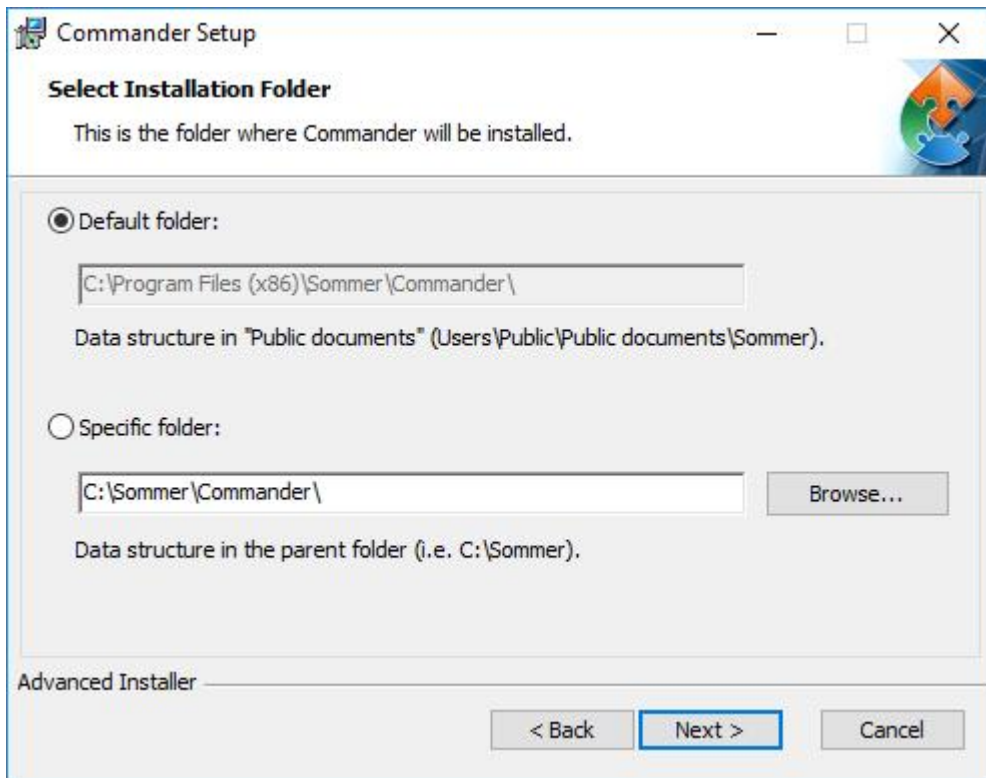

7. Select the features to be installed and click **Next**

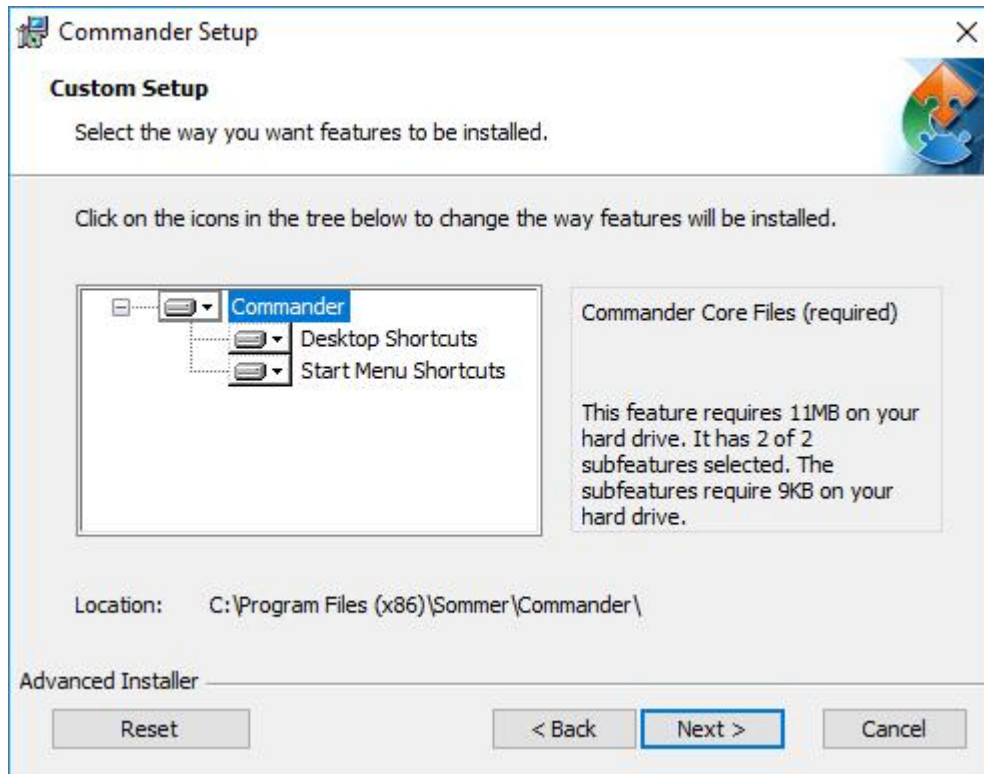

8. Click **Install** to start the installation.

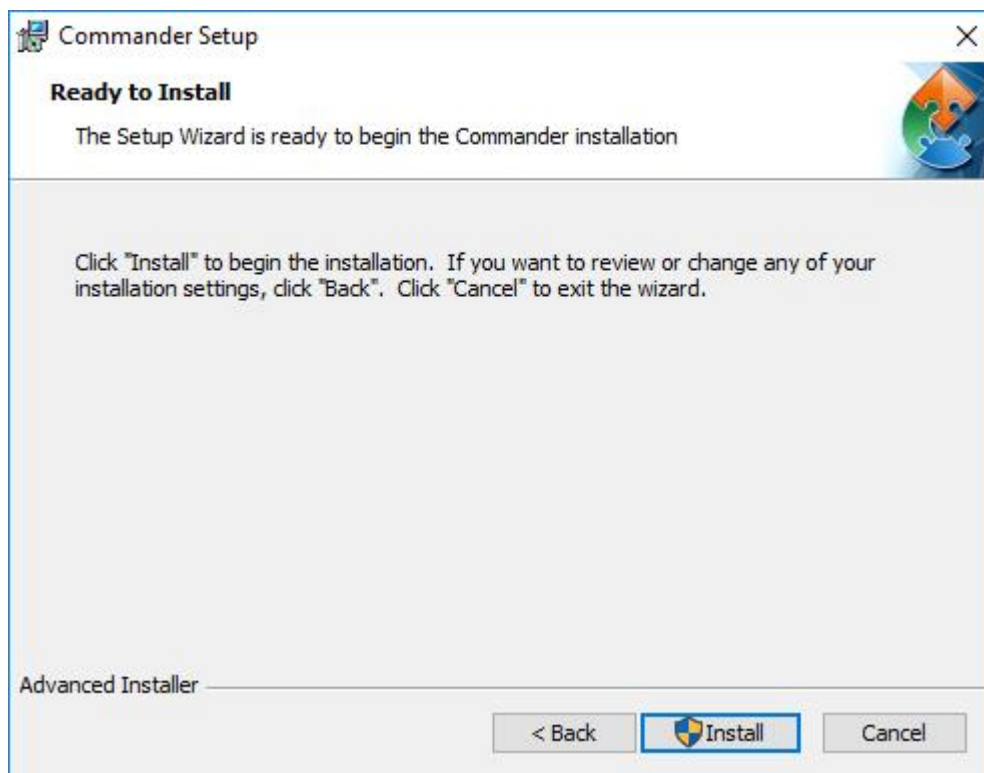

- Click **Finish** to complete the installation.

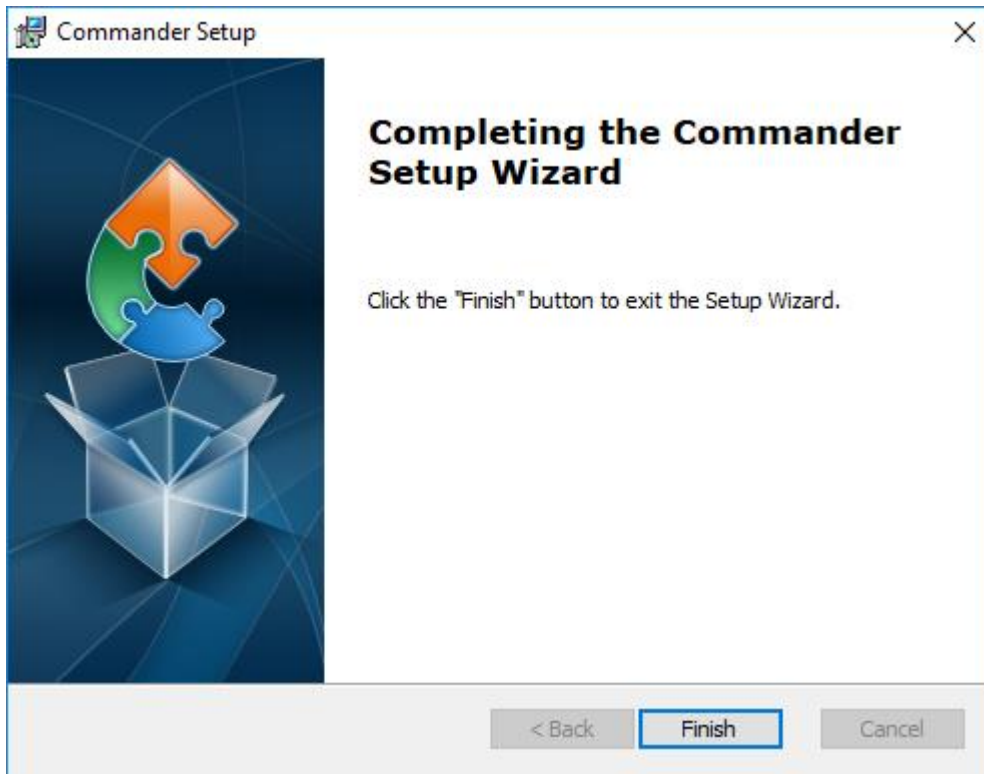

## 11.4 Change authorization

To prevent unintended changes of parameters in the **Technics** menu authorization is generally set to **Normal**. Parameter modifications in **Technics** are enabled by switching the authorization level to **Expert** as described below:

- On the upper tab bar click on **Options** and select **Common**.
- In the Options window select authorization **Expert** and click **OK**.

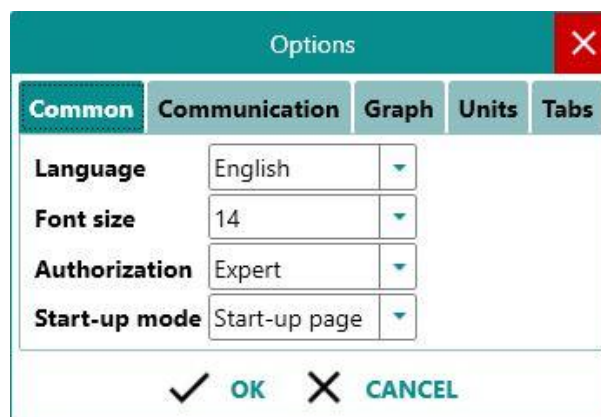

## 11.5 Working with connections

### 11.5.1 Establish a connection with the Communication assistant

1. Install the Commander support software as described in [Installation of Commander](#).
2. Connect the device to your PC.
3. Start the Commander software on your PC.
4. Click on **Communication assistant** on the right-hand side of the Commander window and follow the instructions. During this procedure the communication assistant will search for connected devices. Upon successful completion, the new connection is added to the connections list (tab **Connections (F8)**). See also pictures steps 1 to 8 in [Create a station with the Communication assistant](#).
5. In the **Communication** section at the right-hand side of the Commander window select **Mode Connection** and the previously created connection from the drop-down list.
6. Click **Connect** to establish a connection with the MRL-8P. If the connection was successful a green icon is displayed at the top-right corner of the Commander window.

To view the settings of the connected device or to read the current measurements, follow the steps described in [Download setup](#) and [Record measurements](#).

### 11.5.2 Establish a connection manually

1. Install the Commander support software as described in [Installation of Commander](#).
2. Connect the device to your PC.
3. Start the Commander software on your PC.
4. Select the required connection in the **Connections** list of the **Connections (F8)** tab and click **Connect**. If the connection was successful a green icon is displayed at the top-right corner of the Commander window.

If you don't have the required connection available in the **Connections** list, create a new connection as described in [Create a new connection](#).

To view the settings of the connected device or to read the current measurements, follow the steps described in [Download setup](#) and [Record measurements](#).

### 11.5.3 Create a new connection

1. Select the **Connections (F8)** tab in the Commander. If the tab is not shown, select it with pressing **F8**.
2. Click **New connection**.

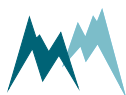

3. In the section **Connection settings** enter a name of the new connection, e.g. *Serial-com1-9600*, and the connection type, e.g. *Serial connection*.
4. Enter the required information for the selected connection type.  
If your MRL-8P is wired to your PC with a RS-232 to USB converter cable, select the port where the device is connected and select a Baud rate of 115200.

## 11.6 Working with stations

### 11.6.1 Create a station with the Communication assistant

In order to manage several data loggers, to connect to a data logger via IP-call and to download data, stations can be created in the Commander software. To view a list of all stations select the tab **Stations (F7)**. If the tab is not shown, select it with pressing **F7**.

Perform the following steps to create a new station with the **Communication assistant**:

1. Click on **Communication assistant** in the Commander-window

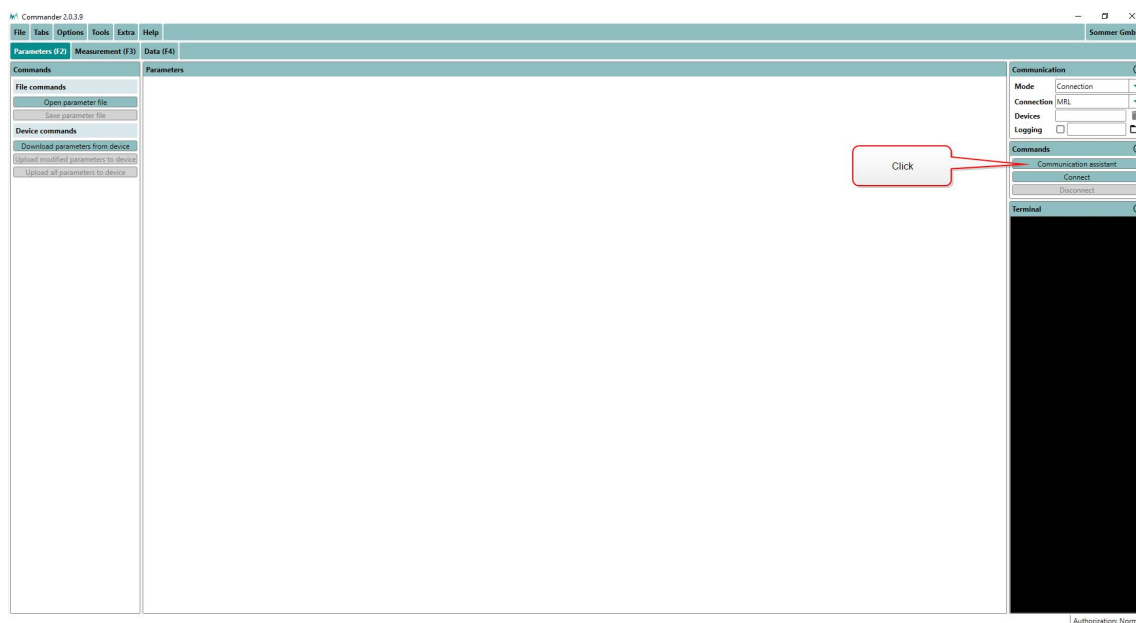

2. In the pop-up window choose the required connection and click **Next**.

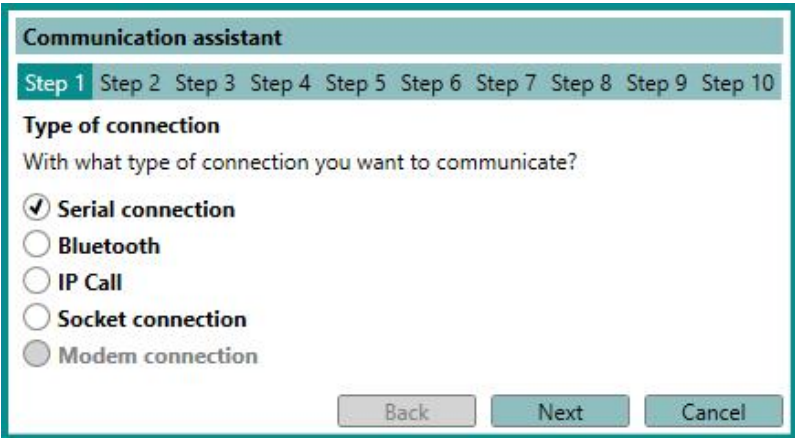

3. Verify that the MRL-8P is connected to your PC and a power supply. Click **Next**.



4. Select *Logger (115200 Bd)* and click **Next**.

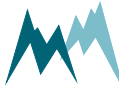
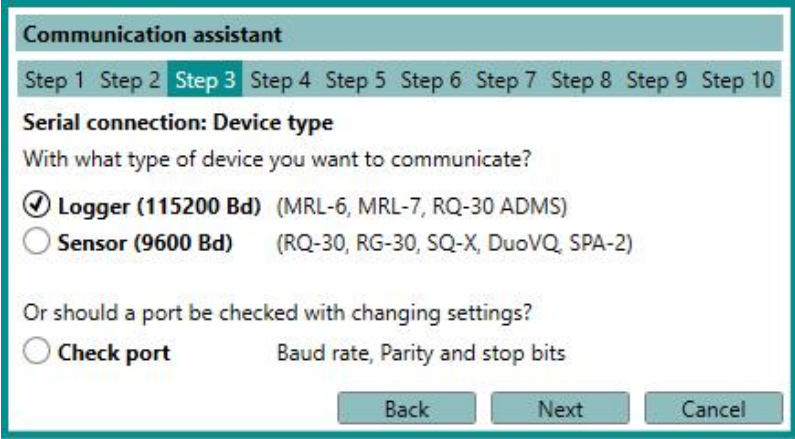

5. Select *Scan ports* and click *Next*.

**Communication assistant**

Step 1 Step 2 Step 3 **Step 4** Step 5 Step 6 Step 7 Step 8 Step 9

**Serial connection: Connection**

Do you want to communicate with an existing or new connection?

**Baud rate** 115200

**Existing connection**

Connection

**New connection**

Select port

Scan ports

Back Next Cancel

6. The Commander now scans all available ports.

**Communication assistant**

Step 1 Step 2 Step 3 Step 4 **Step 5** Step 6 Step 7 Step 8 Step 9

**Serial connection: Scan device**

All available serial ports are sequentially scanned for a device.  
When the first device is found, the procedure is stopped.

**Scan ports**

Port: 11

4/7

Back Next Cancel

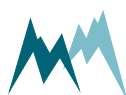

- Adopt the *Name* provided by the communication assistant. Click **Next**.

**Communication assistant**

Step 1 Step 2 Step 3 Step 4 Step 5 **Step 6** Step 7 Step 8 Step 9

**Serial connection: New connection**

A device has been detected with the connection.  
The connection is created.

**Name**

**Type** Serial connection

**Port**

**Baud rate** 115200

Back Next Cancel

- The Commander now scans the selected port for connected devices.

**Communication assistant**

Step 1 Step 2 Step 3 Step 4 Step 5 Step 6 **Step 7** Step 8 Step 9

**Serial connection: Scan devices**

All available devices are scanned.

**Scan devices**  
Scan all devices "0099" in level "1"

Devices
0000 41/2

12/15

Back Next Cancel

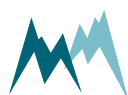

9. Adopt the *Name* of the new station or enter a new name. Click [Next](#).

**Communication assistant**

Step 1 Step 2 Step 3 Step 4 Step 5 Step 6 Step 7 **Step 8** Step 9

**New station**  
No matching station has been found.  
Changes of the station number are performed on the device as well.

**Station ID**

**Station number**

**Name**

**Devices** ▾ 0000 MRL

**Do you want to save the station?**

Back Yes No

10. A new station has now been created. Click [Finish](#).

**Communication assistant**

Step 1 Step 2 Step 3 Step 4 Step 5 Step 6 Step 7 Step 8 **Step 9**

**Station selected**  
The station has been selected and can now be used.

Back Next Finish

11. The newly created station can now be selected in the [Communication](#) section of the Commander. Click [Connect](#) to activate the connection to your device.

## 11.6.2 Create a station manually

In order to manage several data loggers, to connect to a data logger via IP-call and to download data, stations can be created in the Commander software. To view a list of all stations select the tab [Stations \(F7\)](#).

Perform the following steps to create a new station:

1. In the tab-menu [Stations \(F7\)](#) click [New station](#).
2. Under [Station settings](#) enter the [Station number](#) and [Sommer ID](#). By default both settings are set to the device's serial number (visible on the MRL-8P housing).
3. Select the [Connections](#) used for the station. Multiple selections are possible; the default connection can be selected by ticking the circular field.

- Depending on the connection type, enter the additional information, e.g. **Address** for a Bluetooth connection or **IMSI number** for an IP call.
- Enter the settings for **Data** management. When data are downloaded from a connected MRL-8P they are stored in an archive-file by default. Each archive-file contains the data of a year or month, as selected in **Archive type**. Selection **None** will save all data in one file. The default location for data files is C:\Users\Public\Documents\Sommer\Data\.
- Save the newly created station with the button **Save station**.

## 11.7 Working with measurements

### 11.7.1 Poll continuous measurements

- Establish a connection to your device as described in [Working with connections](#).
- Download the setup of your device as described in [Download setup](#).
- Select the **Measurement (F3)** tab.
- In the **Commands** section click **Start polling measurement**.
- Select the option **Polling with measurements**. Now, the Commander will trigger measurements of the MRL-8P without any delays between measurements. The results are displayed **Measurement values** and plotted in the **Measurement data graph**.
- To finish polling mode click **Stop polling**.

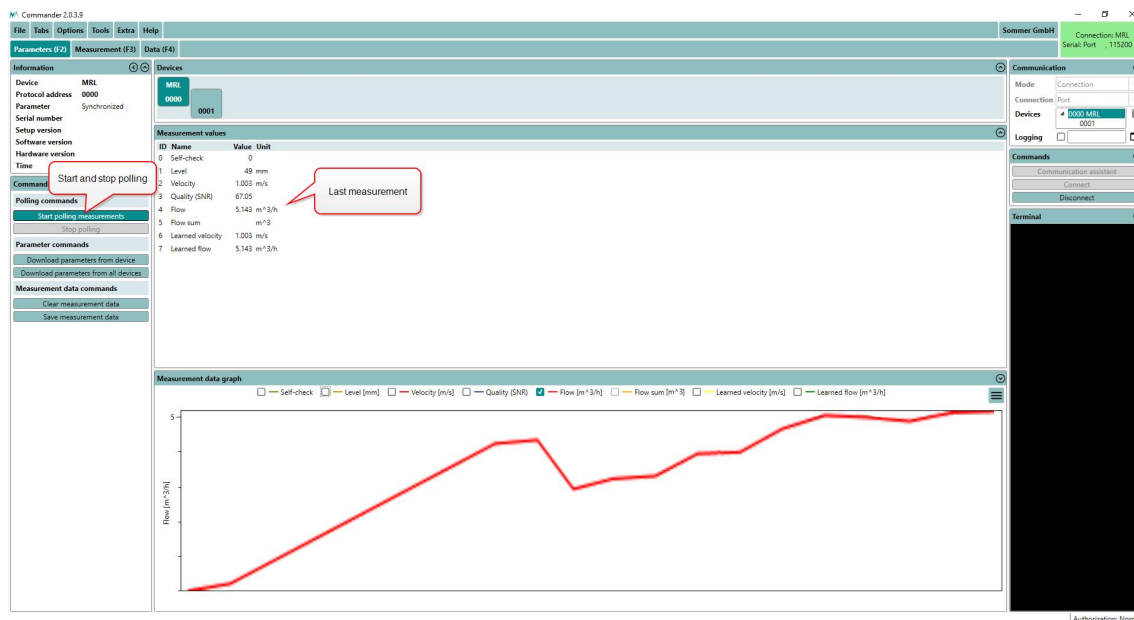

**NOTE** The polling mode stops automatically after 30 minutes.

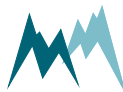

## 11.7.2 Record measurements

1. Establish a connection to your device as described in [Working with connections](#).
2. Download the setup of your device as described in [Download setup](#).
3. Select the [Measurement \(F3\)](#) tab.
4. Make sure that [Measurement output](#) is set to *Measured values push* or *Storage values push*.
5. If the connection with your device is active, the data will now be displayed in the measurement table and updated at the interval specified in the setup. Also, the incoming data strings are displayed in the [Terminal](#).
6. Click [Save measurement data](#) in the [Commands](#) section to save the recorded measurements. The data are saved as a \*.csv file in the SommerXF format.

## 11.8 Working with data

### 11.8.1 View live data

Follow the steps below to view live data acquired from your device:

1. Establish a direct or remote connection with the MRL-8P using the Commander. Use an existing Commander-connection or -station if available.
2. In the [Parameters \(F2\)](#) tab download the parameters of the MRL-8P.
3. Now, there are two options to view the measurement data:
  1. If [Measurement output](#) is set to *Measured values push* or *Storage values push*, data are displayed in the [Measurement \(F3\)](#) tab in the specified measurement interval.
  2. Open the [Measurement \(F3\)](#) tab and click [Start polling measurements](#). This measurement mode can be stopped by clicking [Stop polling](#), or it is finished automatically after 30 minutes.

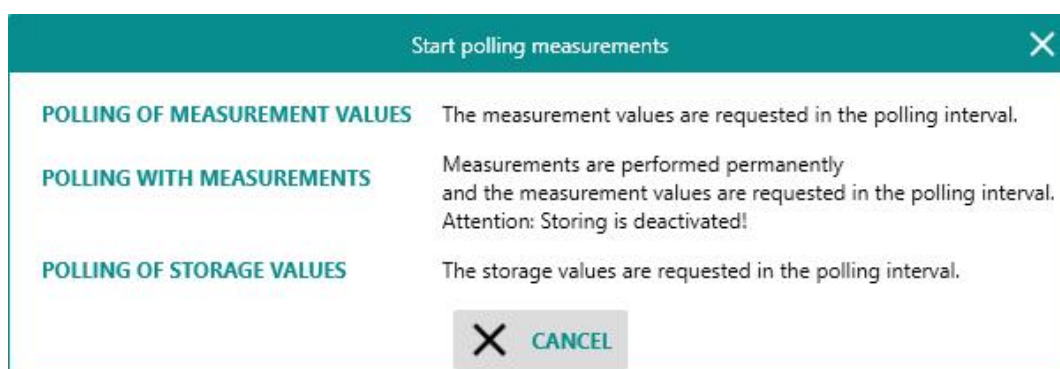

## 11.8.2 Collect measurement data

Follow the steps below to collect data with the Commander software:

1. Establish a direct or remote connection to your Sommer Messtechnik data logger using the Commander. Use an existing Commander-connection or -station if available.
2. If no station has been defined for your data logger, create one as described in [Create a station with the Communication assistant](#).
3. Open the **Data (F4)** tab and select your station.
4. Click **Transfer data manually**. In the pop-up window the available data are displayed by the timestamps on the left and right, which correspond to the oldest and most recent data records. Move the slider to the time from which data need to be collected and press **OK**. Depending on the number of records to be downloaded this may take a few seconds or several minutes. The downloaded data are stored as csv-files in the default installation path of the Commandersoftware, generally `C:\Users\Public\Documents\Sommer\Data`, or in a subfolder as specified in the station (**Archive subfolder** in **Station settings**).



**NOTE** If a station has been defined, data since the last transfer can be downloaded.

5. After download is complete, the data are displayed in the graph of the Data (F4) tab. See [View collected data](#) for some features of the graph-tool.

## 11.8.3 View collected data

Follow the steps below to view collected data with Commander:

1. Once measurement data have been collected, open the **Data (F4)** tab and click **Open data file** to select the file you want to view. The data are now loaded and displayed in the graph.

Several actions can be used to navigate within the graph:

- Select a data window by pressing the right mouse button and spanning a rectangular box.
- Select a certain time range by moving the mouse over the time axis with the right mouse button pressed.
- Select a certain value range by moving the mouse over the value axis with the right mouse button pressed.
- View all data by pressing the right mouse button within the graph pane.



**NOTE** Collected data are stored in the SommerXF format, a semicolon-delimited csv-file, which can be viewed with any text editor or spreadsheet tool.

## 11.9 Working with setups

### 11.9.1 Download setup

1. Establish a connection to your device as described in [Working with connections](#).
2. Select the [Parameters \(F2\)](#) tab in the Commander software.
3. In the [Commands](#) section click [Download parameters from device](#).

The Commander now downloads the setup currently active on the MRL-8P. This may take some time if you are downloading the setup for the first time to your PC. Consecutive downloads of a setup with the same version number will be faster as the parameter structure is already available.

You can now save the setup file by clicking [Save parameter file](#), or edit the settings as described in [Edit setup](#).



**TIP** Save the setup on your PC before you make any changes!

### 11.9.2 Open a setup file

1. Start the Commander on your PC and connect to your MRL-8P either directly with the USB to RS232 converter cable or the optional Bluetooth connection.
2. Open the [Parameters \(F2\)](#) tab and click [Open parameter file](#). Select the required file (extension .xml or .xmla).

### 11.9.3 Edit setup

1. Open the setup file as described in [Open a setup file](#) or download it from your device as described in [Download setup](#).
2. Adapt the values of the settings in question and press Enter after each. After you have changed a value, its text box will turn red.



**NOTE** If you have entered a value outside the data range of the setting, it will be forced to the next valid value! The valid range of each setting is listed in the [Parameter definitions](#).

3. After you have adapted all required settings save the setup file and/or upload the setup to your device by clicking [Upload modified parameters to device](#).

Once the setup has been saved or uploaded, the modified red text boxes will turn white again, indicating that the settings have been saved/applied.

### 11.9.4 Upload new setup file

1. Establish a connection to your device as described in [Working with connections](#).
2. Select the [Parameters \(F2\)](#) tab.
3. Download the setup currently on the MRL-8P as described in [Download setup](#) and save it by clicking [Save parameter file](#). This step is recommended to have the latest setup available for documentation.
4. Click [Open parameter file](#) and select the required setup file (\*.xlmd) on your PC.
5. Click [Upload all parameters to device](#). This transfers the current setup to the MRL-8P.
6. To verify the correct upload click [Download parameters from device](#). This will display the present setup of the MRL-8P.

### 11.10 Update firmware

1. Connect the MRL-8P to your PC with the USB to RS232 converter cable.
2. Make sure no connection is active in the Commander (no green icon at the top-right corner).
3. Click on the menu item [Extra](#) and select [Start Programmer](#).
4. Select the firmware file (\*.hex) provided by SOMMER Messtechnik. Make sure the file is stored on your PC and not on a USB or network drive.
5. Choose the COM-port the data logger is connected to and a Baud-rate of 57'600.
6. Perform the following three steps in short sequence:
  - Click [Program](#)
  - Unpower the data logger
  - Wait 3...5 seconds to enable full activation of the bootloader and a correct restart (capacitors must be discharged, and if the device had been in sleep mode, this can take some time)
  - Repower the data logger

The firmware currently present on the data logger is now erased and the new one copied to the data logger. During the update process the pop-up window may show the following messages:

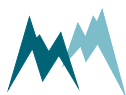

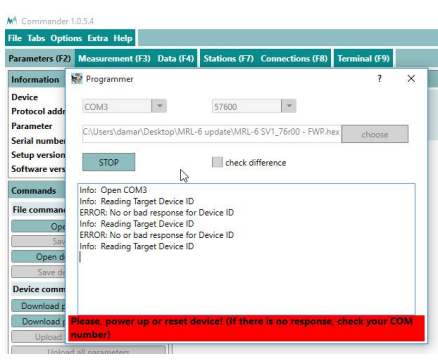

The device is not ready; power needs to be on.

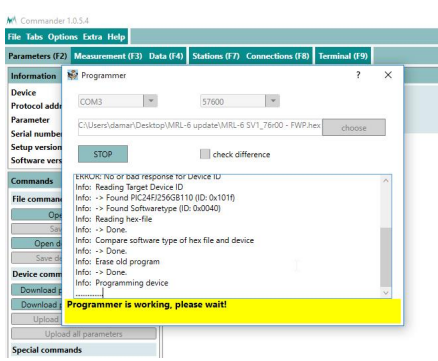

The programmer is active.

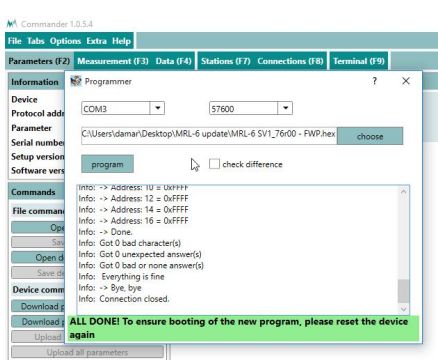

The firmware update has finished.

7. Close the programmer-window as soon as the firmware update has finished.
8. Switch off and repower the data logger again.
9. Open the **Parameters (F2)** tab.
10. Click **Download parameters from device**. The download of the new parameter list might take a few minutes as the parameter structure may need to be downloaded as well. After completion the new firmware and setup versions will be displayed in the **Information** section.

## 11.11 Set the device time

1. Establish a connection to your device as described in [Working with connections](#).
2. Download the setup of your device as described in [Download setup](#). The current time of the device is displayed in the **Information** section.
3. Click **Set device** time to synchronize the time of the device.

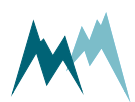

# 12 Communication with the MRL-8P

## 12.1 Options

The following options can be used to communicate with the MRL-8P:

- [RS-232 using an USB converter](#) (available as an accessory)
- [Bluetooth](#)
- [Ethernet connection](#)
- [IP-Call](#)
- [Socket connection](#)
- [Radio connection](#)

All these options are available in the Commander software. Alternatively, a terminal editor can be used to communicate with the data logger.

### 12.1.1 RS-232 using an USB converter

Perform the following steps to set up the communication between the MRL-8P and your PC:

1. Install the Commander software on your PC.
2. Connect the provided USB to RS-232 converter to your PC. If required, install the driver of the USB to RS-232 converter.
3. Start the Commander software.
4. Click on [Communication assistant](#) on the right-hand side of the Commander window.

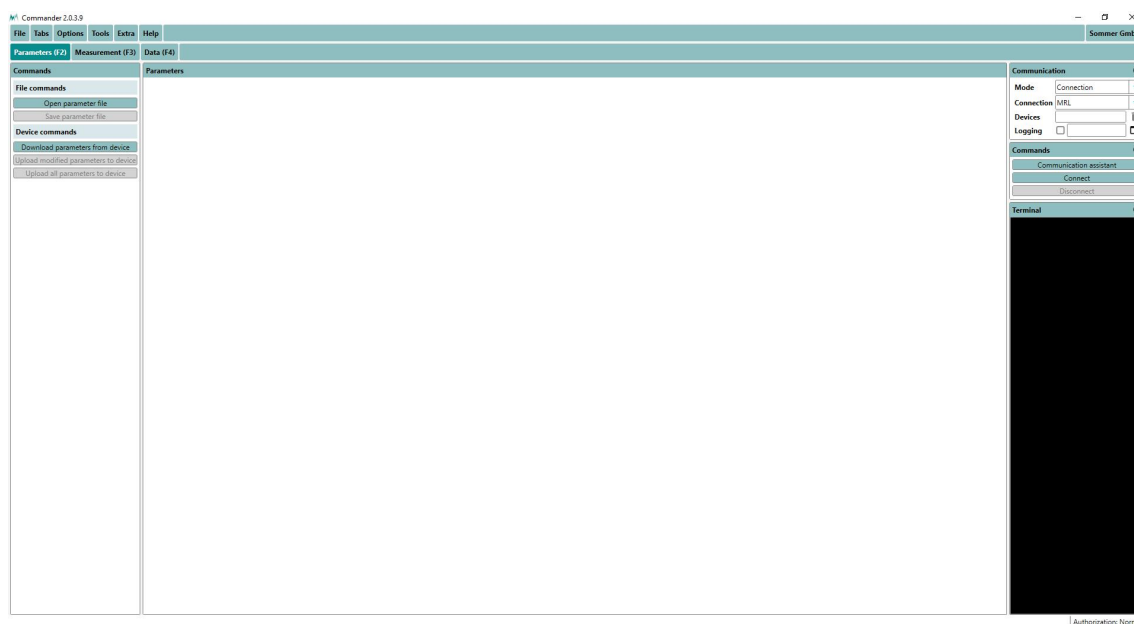

5. Select *Serial Connection* and press *Next*.

Communication assistant

Step 1 Step 2 Step 3 Step 4 Step 5 Step 6 Step 7

**Type of connection**  
With what type of connection you want to communicate?

**Serial connection**

**Bluetooth**

**IP Call**

**Socket connection**

**Radio connection**

← **BACK** → **NEXT** ✕ **CANCEL**

6. Make sure the MRL-8P is powered either by internal or external batteries and press *Next*.

Communication assistant

Step 1 Step 2 Step 3 Step 4 Step 5 Step 6 Step 7

**Serial connection: Device fully functional?**  
Make sure that the device is connected and supplied.  
Click "Next" to proceed.

← **BACK** → **NEXT** ✕ **CANCEL**

7. Select *Logger (115200 Bd)* and press *Next*.

Communication assistant

Step 1 Step 2 Step 3 Step 4 Step 5 Step 6 Step 7

**Serial connection: Device type**  
With what type of device you want to communicate?

**Logger (115200 Bd)** (MRL-6, MRL-7, RQ-30 ADMS)

**Sensor (9600 Bd)** (RQ-30, RG-30, SQ-X, SQ-X, SV-a)

**Modbus (19200 Bd)** (Only for devices set to Modbus)

Or should a port be checked with changing settings?

**Check port** Baud rate, Parity and stop bits

← **BACK** → **NEXT** ✕ **CANCEL**

8. Either tick **Connection** and select a previously configured connection, or tick **Select port** and select the COM port that was assigned to the USB/RS-232 converter; then click **Next**.

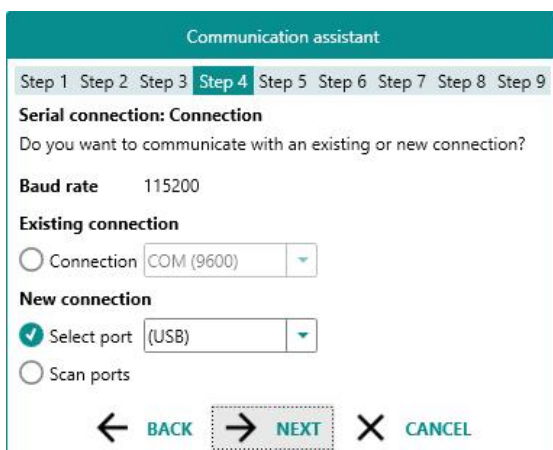

If more than one COM ports are listed and you are not sure which one to select, open the Windows Device Manager (press **Windows-key** and type *device manager*) and expand the menu **Ports (COM & LPT)**. By unplugging and re-plugging your USB/RS-232 converter you can identify the number of the desired port.

9. Port is scanned for a device ... Select **New connection** and click **Next**.

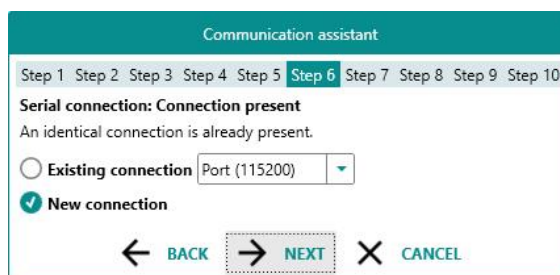
10. Assign a name to the connection and click **Next**. The software now searches for connected devices. This procedure can take several seconds.

The first screenshot shows the 'Communication assistant' dialog box at Step 6. The title is 'Communication assistant'. The progress bar shows Step 6 is active. The text reads: 'Serial connection: New connection. A device has been detected with the connection. The connection is created.' Below this are fields for 'Name' (Port (115200)), 'Type' (Serial connection), 'Port', and 'Baud rate' (115200). At the bottom are buttons for 'BACK', 'NEXT', and 'CANCEL'.

The second screenshot shows the 'Communication assistant' dialog box at Step 7. The title is 'Communication assistant'. The progress bar shows Step 7 is active. The text reads: 'Serial connection: Scan devices. All available devices are scanned.' Below this is a section titled 'Scan devices' with the subtext 'Open communication'. A table lists 'Devices' with one entry: '0000 MRL'. Below the table is a progress bar and the text '2/9'. At the bottom are buttons for 'BACK', 'NEXT', and 'CANCEL'.

11. Select if you want to create a new station. If yes, assign an appropriate name. If a station already exists, it will be recognized and automatically selected.

The screenshot shows the 'Communication assistant' dialog box at Step 8. The title is 'Communication assistant'. The progress bar shows Step 8 is active. The text reads: 'New station. No matching station has been found. Changes of the station number are performed on the device as well.' Below this are fields for 'Station ID', 'Station number', 'Name' (MRL), and 'Devices' (0000 MRL). At the bottom is the question 'Do you want to save the station?' with buttons for 'BACK', 'YES', and 'NO'.

12. Click **Finish**. Upon completion, the newly created connection is displayed in the **Communication** section of the Commander.

The screenshot shows the 'Communication assistant' dialog box at Step 9. The title is 'Communication assistant'. The progress bar shows Step 9 is active. The text reads: 'Station selected. The station has been selected and can now be used.' At the bottom are buttons for 'BACK', 'NEXT', and 'FINISH'.

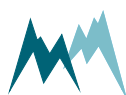

13. If the connection was successful a green icon is displayed at the top-right corner of the Commander window.

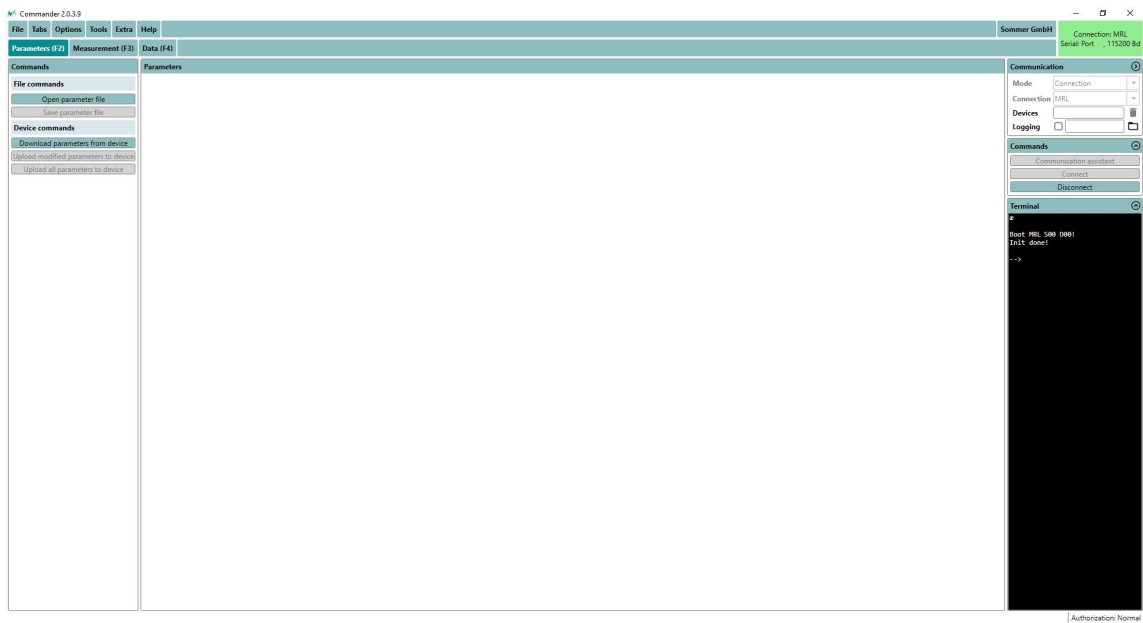

All configured connections can be viewed under the tab [Connections \(F8\)](#).

Alternatively, a connection can be configured manually; please consult the Commander manual for detailed instructions.

## 12.1.2 Bluetooth

Perform the following steps to set up the communication between the MRL-8P and your PC:

1. Install the Commander software on your PC.
2. Make sure your PC has an internal Bluetooth or a Bluetooth dongle is connected.
3. Start the Commander software.
4. Make sure the MRL-8P is powered



5. Click on **Communication assistant** on the right-hand side of the Commander window.

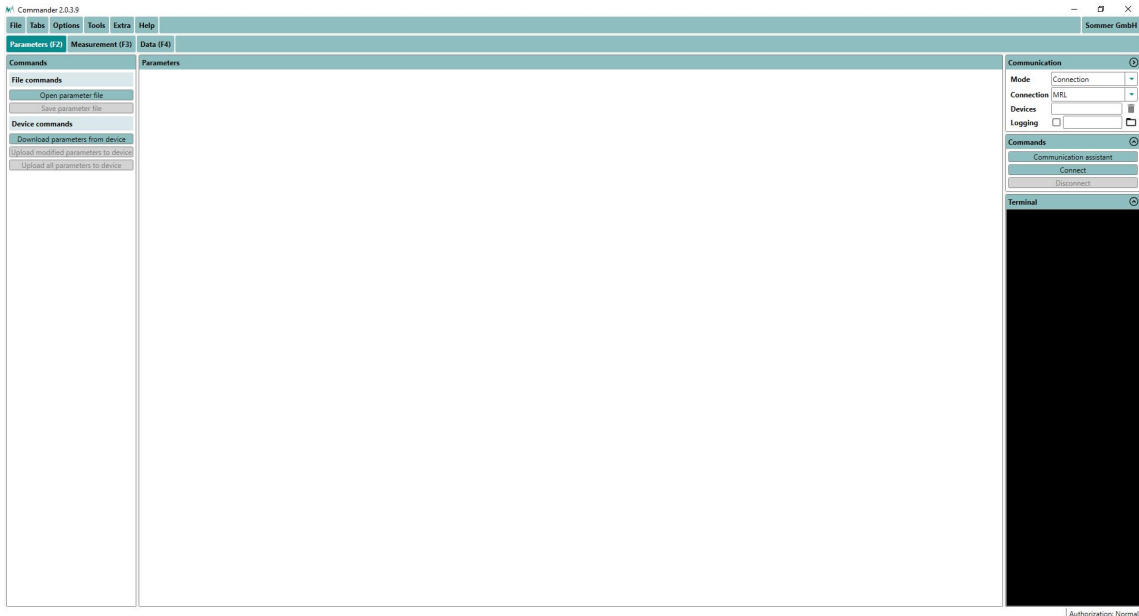

6. Select **Bluetooth** and press **Next**.

On the MRL-8P press the button **DATA BT** until the message hold for BT and then waiting for BT no access is displayed, press **Next**.

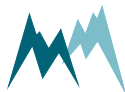

7. All available Bluetooth-devices are scanned ...

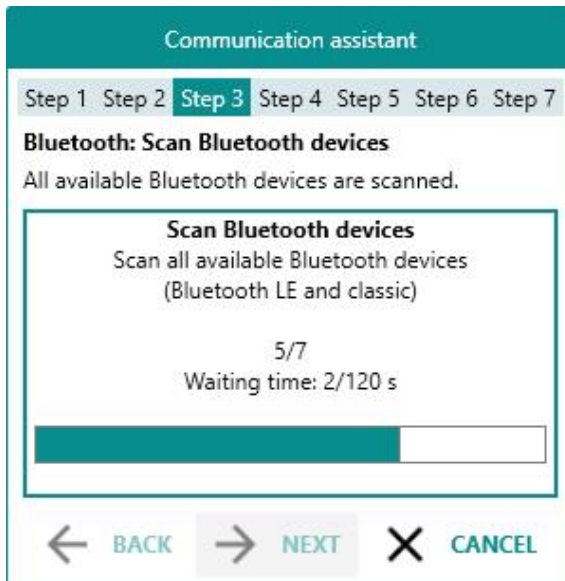

8. Select the device you want to connect to and click **Next**. The Bluetooth ID of your data logger is printed on a sticker on the MRL-8P housing. The software now searches for devices connected to your data logger. This may take a few seconds.

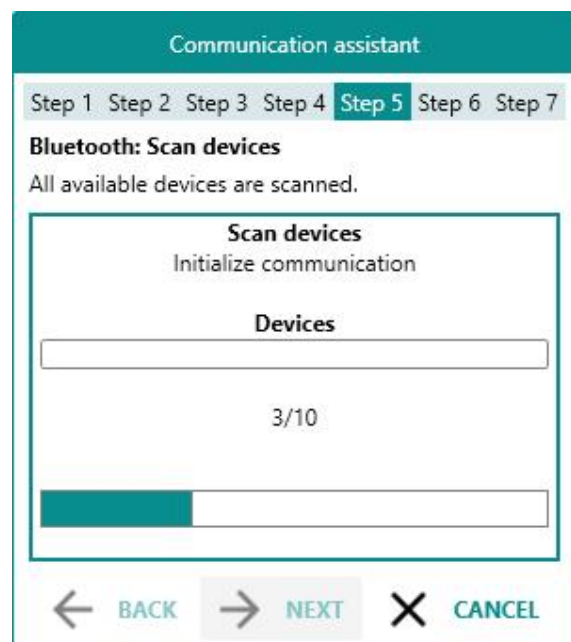

**TIP** The Bluetooth ID is also displayed in the list returned by the special function [Device status](#).

- Select if you want to create a new station. If yes, assign an appropriate name. If a station already exists, it will be recognized and automatically selected. Click **Finish**. Upon completion, the newly created connection is displayed in the **Communication** section of the Commander.

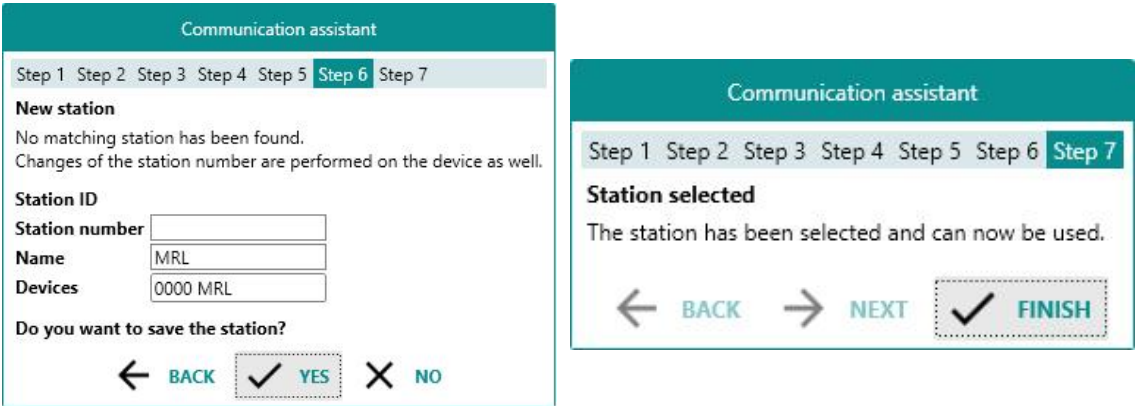

- If the connection was successful a green icon is displayed at the top-right corner of the Commander window.

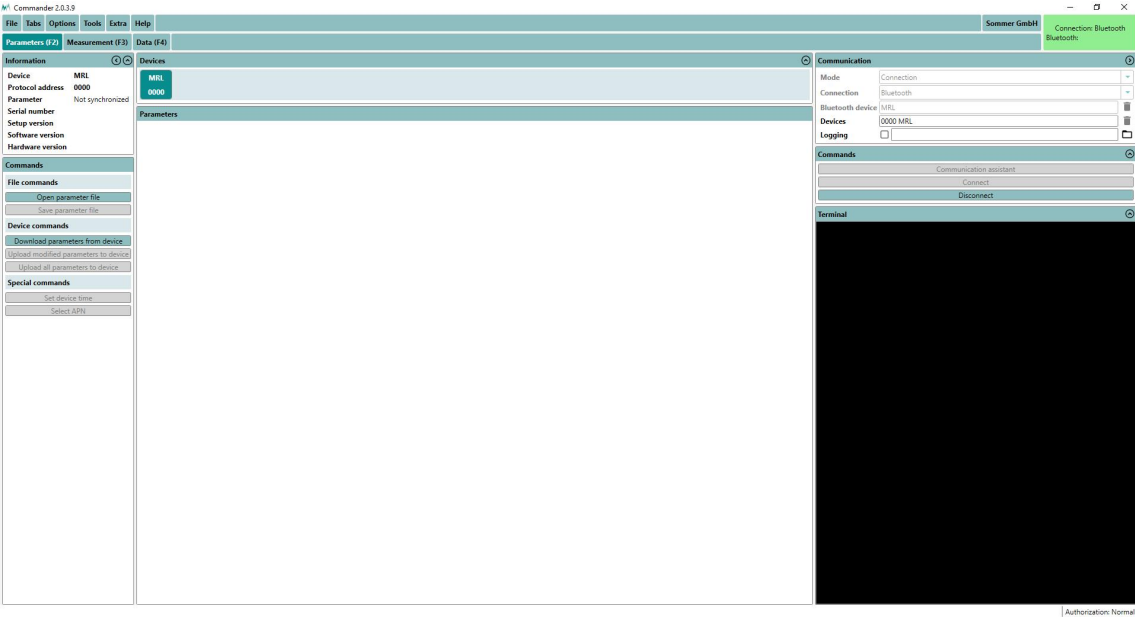

All configured connections can be viewed under the tab **Connections (F8)**. Alternatively, a connection can be configured manually; please consult the Commander manual for detailed instructions.

### 12.1.3 Ethernet connection

Perform the following steps to set up the communication to your MRL-8P via Ethernet:



1. Start the Commander software.
2. Click on **Communication assistant** on the right-hand side of the Commander window.

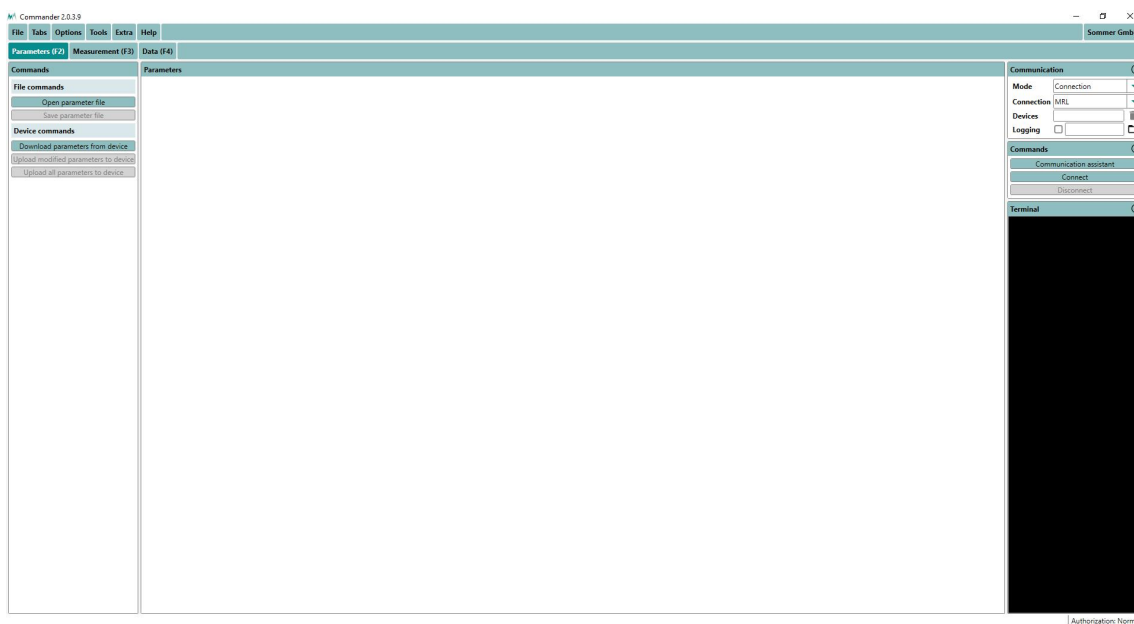

3. Select **Socket connection** and click **Next**.



4. If you set up a new connection, select **New connection** and click **Next**.

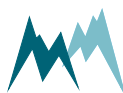

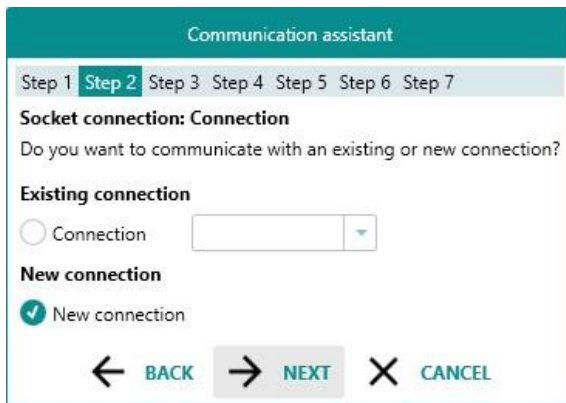

5. Enter a name for the connection and click [Next](#).

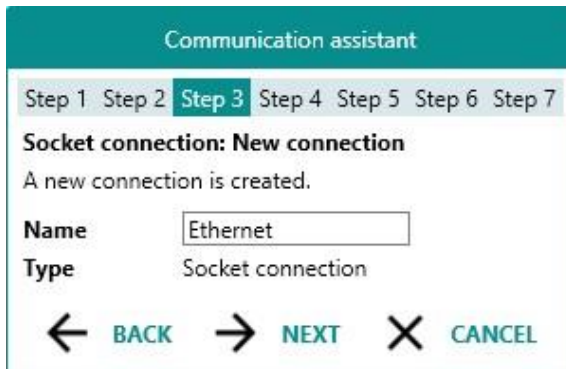

6. Enter the [IP Address](#) and the [Port](#) number of the device and click [Next](#).

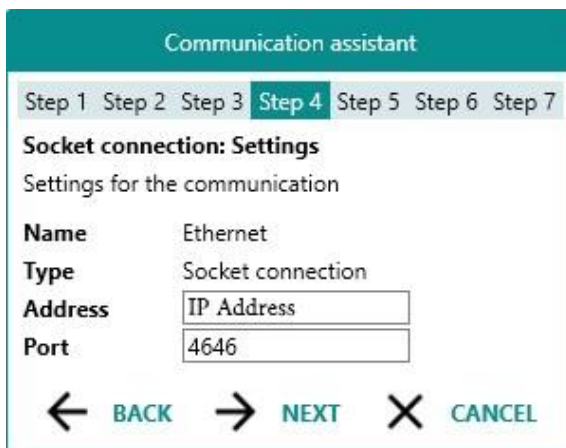

7. The Commander is now searching for your devices. This may take several seconds. After the communication assistant has completed the search, verify the new station settings and press [Yes](#).

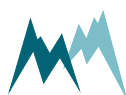

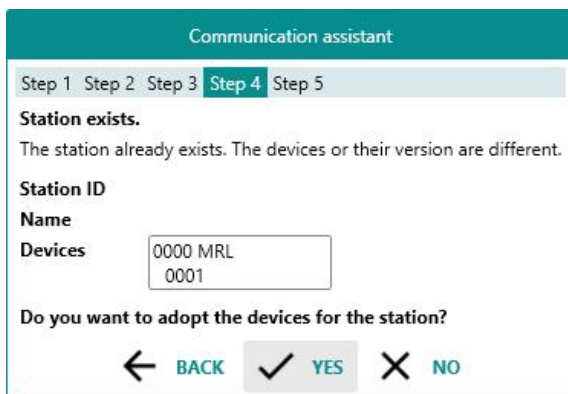

- Click **Finish**. Upon completion, the newly created station is displayed in the **Communication** section of the Commander.



- Click **Connect** to open the connection with the data logger. If the connection was successful a green icon is displayed at the top-right corner of the Commander window.

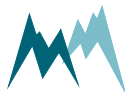
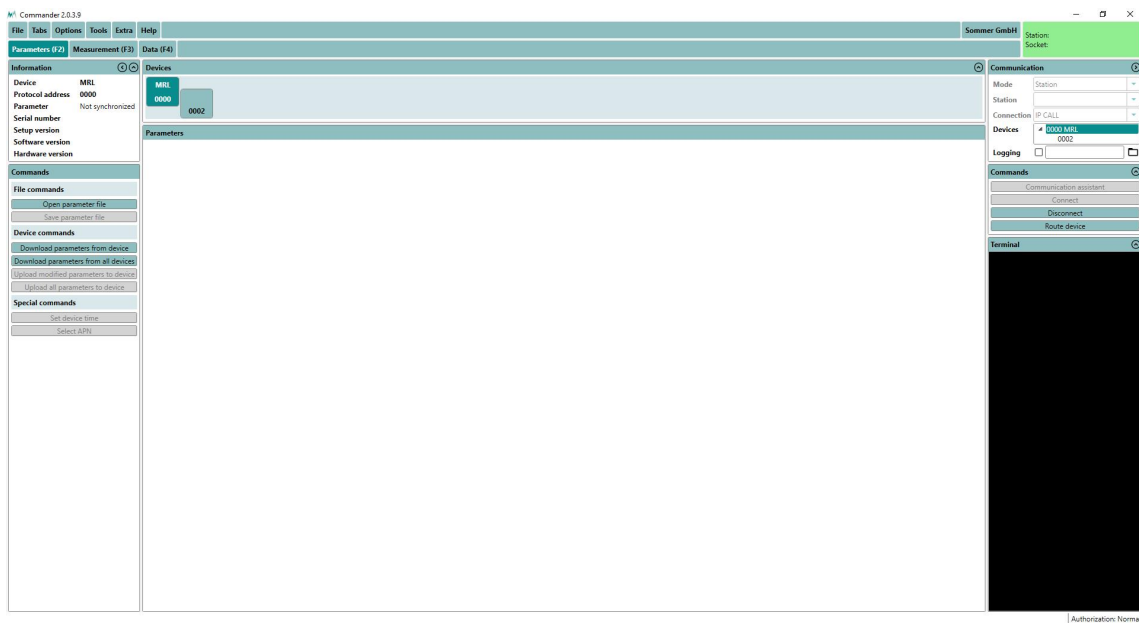

### 12.1.4 IP-Call

Perform the following steps to set up the communication between the MRL-8P and your PC:

1. Make sure the MRL-8P has been configured for remote access (see [How to enable remote access](#)).
2. Start the Commander software.
3. Click on **Communication assistant** on the right-hand side of the Commander window.

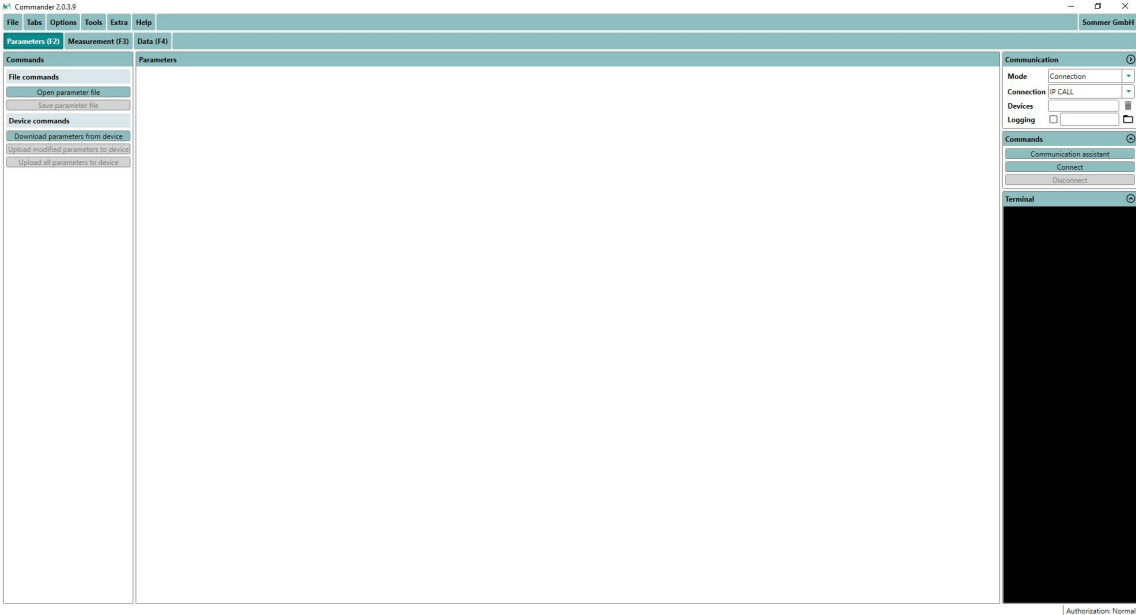

4. Select **IP Call** and click **Next**.  
 Enter the **Station number** (by default the serial number of the device), **Sommer ID** (generally the serial number of the device) and your **IMSI number** (to retrieve the number see [How to do a modem test](#)). Then click **Next**.



- The Commander is now searching for your devices. This may take up to a few minutes. After the communication assistant has completed the search, the detected devices are listed. Enter a suitable station **Name** and click **Yes**. Click **Finish**. Upon completion, the newly created station is displayed in the **Communication** section of the Commander.

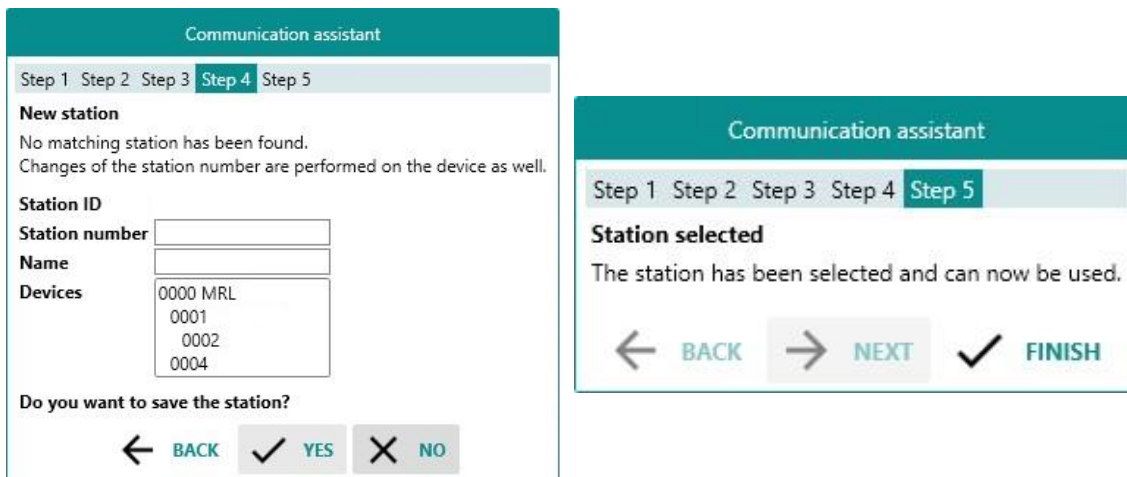

- If the connection was successful a green icon is displayed at the top-right corner of the Commander window.

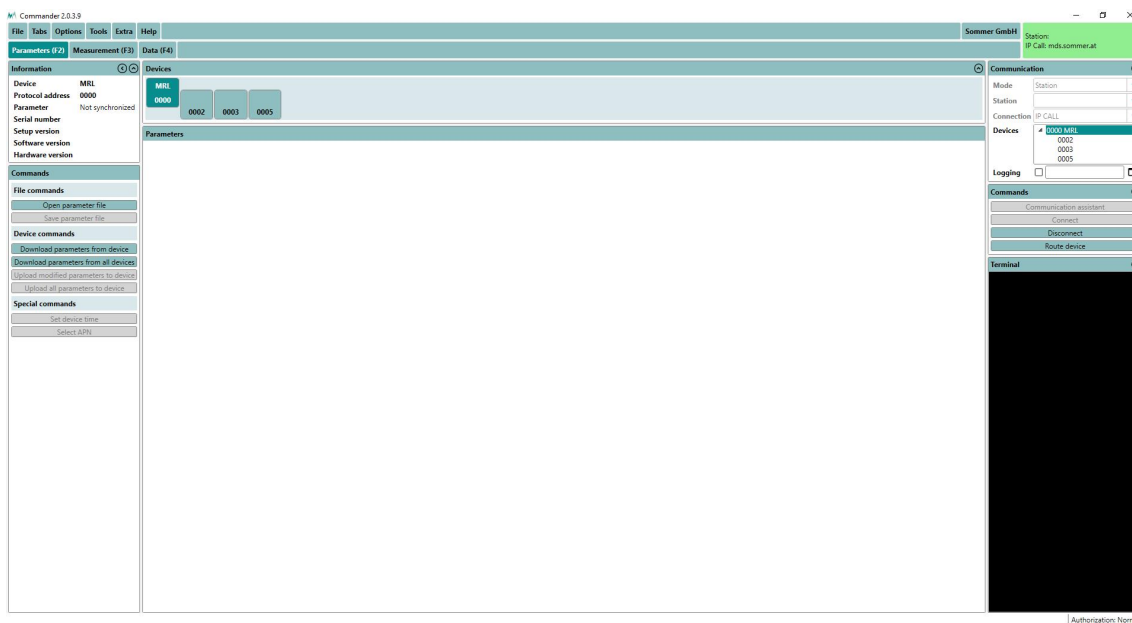

## 12.1.5 Socket connection

Perform the following steps to set up the communication between the MRL-8P and your PC:

1. Start the Commander software.
2. Click on **Communication assistant** on the right-hand side of the Commander window.

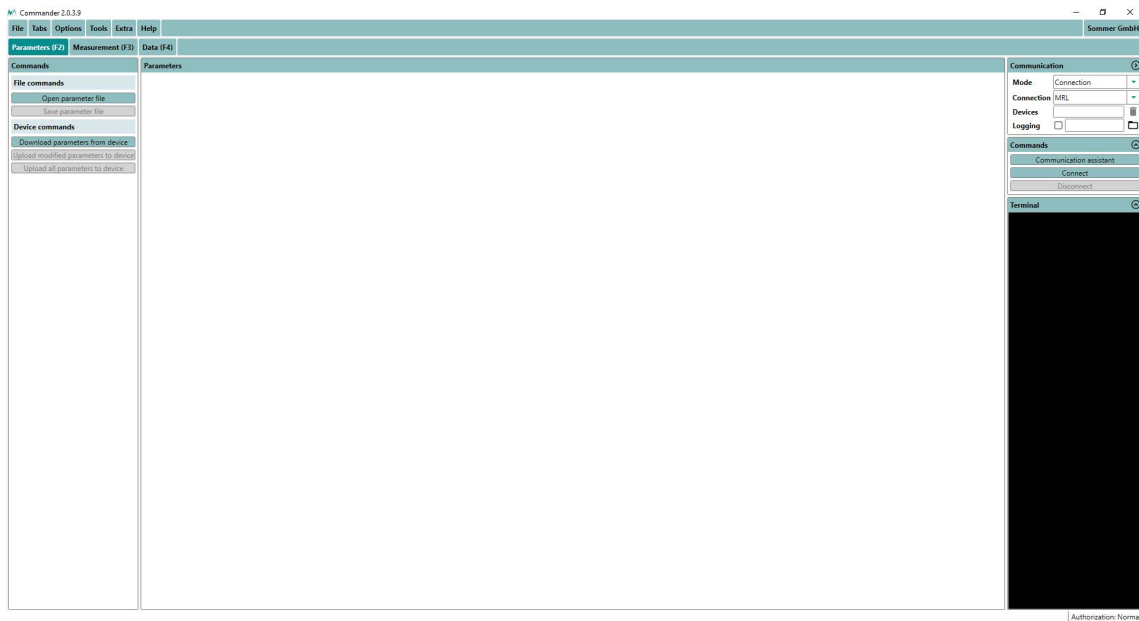

3. Select **Socket connection** and click **Next**.  
Enter the **IP Address** and the **Port** number of the device and click **Next**.

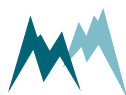
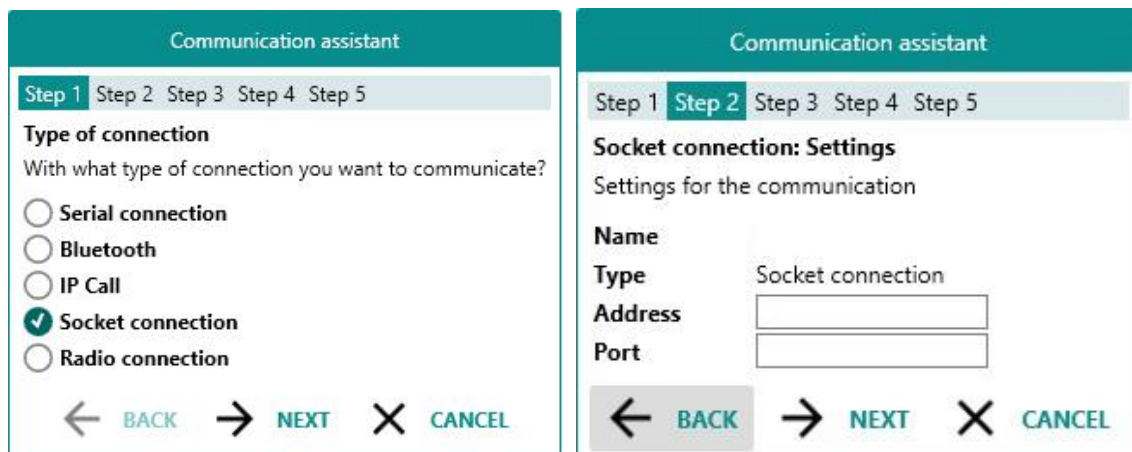

4. The Commander is now searching for your devices. This may take several seconds. After the communication assistant has completed the search, verify the new station settings and press **Yes**.  
Click **Finish**. Upon completion, the newly created station is displayed in the **Communication** section of the Commander.

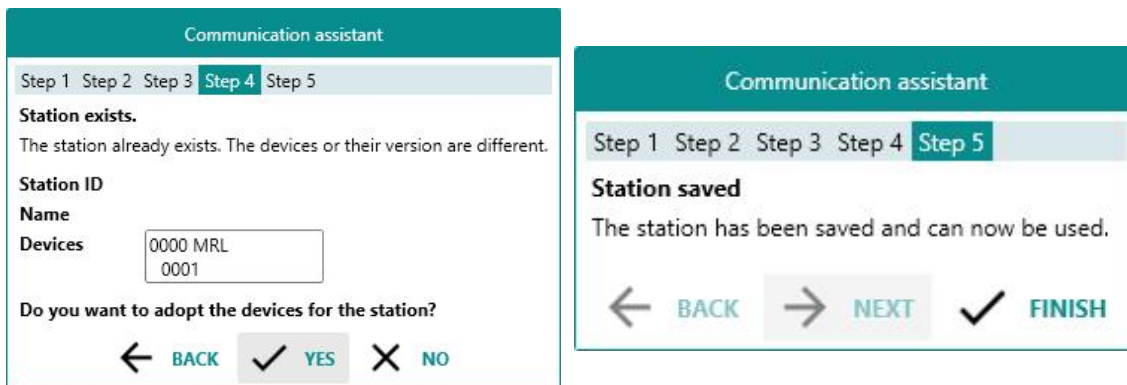

5. If the connection was successful a green icon is displayed at the top-right corner of the Commander window.

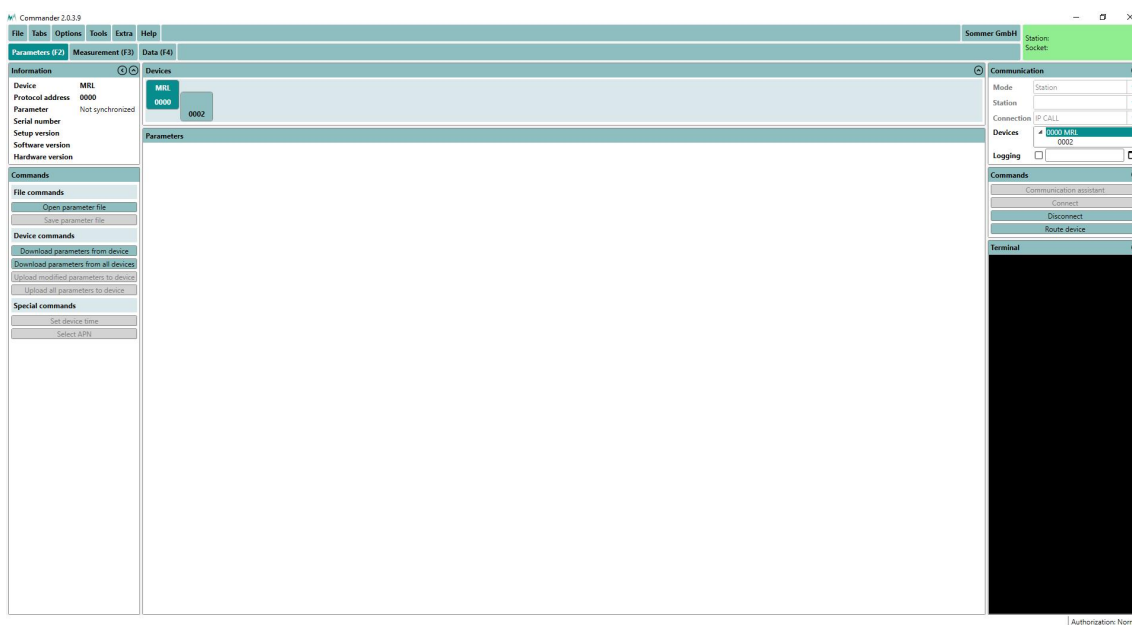

## 12.1.6 Radio connection

To enable radio communication, the COM interface of the MRL-8P must first be enabled to connect with a Sommer Messtechnik radio device. This is done by setting the following parameters in the **Port** sub-menu of the **COM** menu:

Parameter	Setting
Baud rate	19200
Flow control	DFM-RC for Sommer Messtechnik DFM point-to-point radios DFM-TM for Sommer Messtechnik DFM Tiny mesh radios

Follow the steps below to connect to a radio-enabled MRL-8P:

1. Make sure the MRL-8P and the radio devices are connected properly. See the DFM manual for details.
2. Start the Commander software.
3. Click on **Communication assistant** on the right-hand side of the Commander window.
4. Select **Radio connection** and click **NEXT**.  
Select **New connection** and click **NEXT**.

Communication assistant

Step 1 Step 2 Step 3 Step 4 Step 5

**Type of connection**  
With what type of connection you want to communicate?

Serial connection

Bluetooth

IP Call

Socket connection

Radio connection

← BACK → NEXT × CANCEL

Communication assistant

Step 1 Step 2 Step 3 Step 4 Step 5 Step 6

**Radio connection: Connection**  
Do you want to communicate with an existing or new connection?

**Existing connection**

Connection

**New connection**

New connection

← BACK → NEXT × CANCEL

- Select the COM Port of the connected radio device, set Baud rate to 19200 and enter a Name of the connection. Click NEXT to continue.

The Commander is now searching for the MRL-8P. This may take several seconds.

The left screenshot shows the 'Communication assistant' at Step 3, 'Radio connection: New connection'. It prompts 'A new connection is created.' and includes input fields for Name (Radio (19200)), Type (Radio connection), Port (USB), and Baud rate (19200). Navigation buttons BACK, NEXT, and CANCEL are at the bottom.

The right screenshot shows Step 4, 'Radio connection: Scan devices'. It states 'All available devices are scanned.' and features a 'Scan devices' section with 'Initialize communication' and a 'Devices' list. A progress bar indicates 2/9 devices. Navigation buttons BACK, NEXT, and CANCEL are at the bottom.

- After the communication assistant has completed the search, enter a station Name and click Yes.

Click Finish. Upon completion, the newly created station is displayed in the Communication section of the Commander.

The left screenshot shows Step 5, 'New station'. It prompts 'No matching station has been found. Changes of the station number are performed on the device as well.' and includes input fields for Station ID, Station number, Name, and Devices (0000 MRL). A question 'Do you want to save the station?' is followed by BACK, YES, and NO buttons.

The right screenshot shows Step 6, 'Station selected'. It states 'The station has been selected and can now be used.' and includes BACK, NEXT, and FINISH buttons.

- Now you can view the data transmitted by the MRL-8P in the terminal, or download the setup of the MRL-8P by clicking Download parameters from device in the tab Parameters (F2). To view the data see section View live data.

## 12.2 Data output

The MRL-8P includes a RS-232 interface for communication and data output. The measurement values returned are arranged in a fixed sequence and are identified by the index in [Measurement table](#).

### 12.2.1 Output values

The returned measurement data are indexed according to the entries in the [Measurement table](#). The output format is selected in [Protocol type](#).

Index	Measurement value
1	Variable 01 <sup>a</sup>
...	...
99	Variable 99 <sup>a</sup>

<sup>a</sup>According to the acquired variables

Table 1 Output values



**NOTE** The variables listed above can also be configured as auxiliary variables. These are configured in the same way as regular variables but are not stored in the loggers memory. See [Aux measurements, max. number](#) for details.

### 12.2.2 Exception values

Measurement data may be returned with the following exception values:

Value	Description
99999998	Initial value: No measurement has been performed yet.
99999997	Conversion error: Caused by a technical problem.
99999999	Positive overflow
-99999999	Negative overflow

Table 2 Exception values

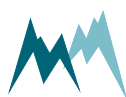

## 12.3 RS-232 communication

### 12.3.1 Configuration

By default the MRL-8P communicates over the serial RS-232 port. If the device is integrated into a data network or connected to a stand-alone data acquisition system, the parameters listed in [COM](#) may need to be adapted.

#### 12.3.1.1 System key and device number

The system key and device number are used to identify a MRL-8P in a bus system. This is essential if multiple devices (MRL-8P and sensors) are operated within the same system.

##### System key

The system key separates different conceptual bus systems. This may be necessary if the remote radio coverage of two measurement systems overlap. In wired setups, the system key should be set to *00*.

##### Device number

The device number is a unique number that identifies a device in a bus system.



**ATTENTION** Do not use a device number twice in your bus system! Otherwise communication will fail!

#### 12.3.1.2 Measurement output

The serial data output can be triggered in the following ways:

ID	Option	Description
1	Just per command (default)	The output is only requested by commands via RS-232.
2	Measured values push	Acquired data are returned automatically after each measurement. Except for the <i>Function Sum</i> , no statistic is applied.
3	Storage values push	Stored data are returned automatically after they have been written to the data logger memory if one of the statistics selected in <i>Function</i> has been applied.

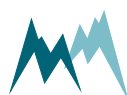

### 12.3.1.3 Operation modes

The MRL-8P supports different modes to acquire data from various digital sensors.

### 12.3.1.4 Waking-up a connected sensor

The MRL-8P supports wake-up of a connected sensor that is in standby mode. Generally, this feature is only used in polling and can be set under [Wake-up sequence](#).

#### 12.3.1.4.1 Sync sequence

The sync sequence is the string `UU~???` and is sent directly before a command. It is used to synchronize the receiving UART.

#### 12.3.1.4.2 Prefix

The prefix is an arbitrary character; the MRL-8P uses a blank. This character is sent prior to any communication. Then the time of the [Prefix holdback](#) is waited and the command is sent afterwards. With this procedure the receiving device has time to wake-up.

### 12.3.1.5 Output protocols

For data output via RS-232 different protocols are available, which can be selected under [Protocol type](#).

## 12.3.2 Data output options

Data are returned in two different formats, selectable in [Protocol type](#):

- [Sommer Bus Protocol \(SBP\)](#)
- [Standard protocol](#)

### 12.3.3 Sommer Bus Protocol (SBP)

The data string of the Sommer Bus Protocol has the following format:

 **EXAMPLE** #M0000G00se01    1461|02    1539|03    25.25|04  
0|0D7E;

A data string contains max. 8 values and is max. 105 characters long.

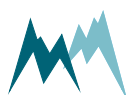

### 12.3.3.1 Header

The header (#M0000G00se) identifies the data by system key, device number and string number.

Parameter	Format	Description
Start character	#	
Identifier	M	M identifies an output string
System key	dd	
Device number	dd	
Command ID	G	G defines an output string with string number
String number	dd	01 Output values dd increments until all values are returned
Command	se	se identifies automatically sent values

Table 3 Header of the Sommer Bus Protocol

### 12.3.3.2 Measurement value

A measurement value (02 1539|) has a length of 8 digits and is returned together with its index. If the measurement value is a floating point number, one digit is reserved for the decimal character. Values are returned right-aligned, so blanks may occur between index and value.

Parameter	Format	Description
Index	dd	2 numbers
Value	xxxxxxxx	8 character right-aligned
Separator		

Table 4 Values in Sommer Bus Protocol

### 12.3.3.3 End sequence

The data string is terminated with a CRC-16 in hex format (0D7E) followed by an end character and <CR><LF>. The CRC-16 is described in [Sommer Messtechnik CRC-16](#).

Parameter	Format	Description
CRC-16	hhhh	4-digit hex number
End character	;	
Control characters	<CR><LF>	Carriage return and Line feed

Table 5 End sequence of the Sommer Bus Protocol

### 12.3.3.4 Example Sommer Bus Protocol

#### 12.3.3.4.1 Output values

The acquired data are returned as in the following example:

 **EXAMPLE** #M0000G00se01 1461|02 1539|03 25.25|04  
0|0D7E;

#M0000G00	Header with system key 00, device number 00 and string number 00
01 1461	Level
02 1539	Distance
03 25.25	Temperature
04 0	Status
0D7E;	Closing sequence

Table 6 Output values in Sommer Bus Protocol

### 12.3.4 Standard protocol

The data string of the Standard protocol has the following format:

 **EXAMPLE** M\_0000      1461      1539      25.25      0

#### 12.3.4.1 Header

The header (M\_0000) identifies the data by system key and device number.

Parameter	Format	Description
Identifier	X_	M_ Measurement values
System key	dd	
Device number	dd	

Table 7 Header of the Standard protocol

#### 12.3.4.2 Measurement values

Measurement values are returned in sequence and are separated by a blank. A measurement value has a length of 8 digits. If the measurement value is a decimal number, one digit is reserved for the decimal character. Values are returned right-aligned, so additional blanks may be returned between values.

Parameter	Format	Description
Separator	[blank]	blank
Value	xxxxxxxx	8 character right-aligned

Table 8 Values in Standard protocol



**NOTE** With the standard protocol the data strings can be very long. In contrast, the strings of the Sommer Bus Protocol are max. 105 characters long.

### 12.3.4.3 End sequence

The data string is terminated with <CR><LF>.

### 12.3.4.4 Example Standard protocol

#### 12.3.4.4.1 Output values

The acquired data are returned as in the following example:

```

EXAMPLE M_0000      1461      1539      25.25      0
    
```

M_0000	Header with identifier for measurement values
1461	Level
1539	Distance
25.25	Temperature
0	Status

Table 9 Output values in Standard protocol

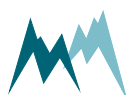

## 12.3.5 Serial commands

### 12.3.5.1 Command structure

The structure of serial commands and answers is described in the following table:

Parameter	Format	Description
Start character	#	
Identifier	X	<p>W Write: MRL-8P returns a confirmation on receipt. This command type demands a closing sequence with a valid CRC-16.</p> <p>S Silent: MRL-8P does not acknowledge the receipt of the command. This command type demands no closing sequence and therefore no CRC-16.</p> <p>R Read: MRL-8P returns the requested measurement value or parameter. This command type demands a closing sequence with a valid CRC-16.</p> <p>T Temporary: Write a volatile, temporary setting and receive a confirmation.</p> <p>A Answer: Answer of device to read or write command.</p>
System key	dd	
Device number	dd	
Command	xxx	See table in section <a href="#">Commands</a> .
Separator		
CRC-16	hhhh	4-digit hex number
End character	;	

**Table 10** Structure of Sommer Bus Protocol commands and answers

### 12.3.5.2 Commands

The following commands can be used with the MRL-8P:

Command	Description
\$pt	Return measurement values
XX	Read a parameter with identifier XX
XX=xxxx	Write a parameter with identifier XX and the value xxx

Table 11 List of Sommer Bus Protocol commands

### 12.3.5.3 Read a parameter value

Read measurement interval (in the example below the menu item B):



**EXAMPLE** #R0000B|32AF;    Answer: #A0000B=300|52E2;

### 12.3.5.4 Request a complete data string

The command \$pt requests a data string as in the following example:



**EXAMPLE**

**Option 1**

#W0000\$pt|4A29;

Answer: #A0000ok\$pt|2664;

**Option 2**

#S0000\$pt|

Answer: none

The measurement data string is returned as soon as the MRL-8P has processed the command.



**NOTE** If **Measurement output** is set to *Measured values push*, the data strings are returned automatically after the measurements have been completed.

### 12.3.5.5 Request a single measurement value

The reading command `R` together with the index of the requested measurement returns a single measurement value. In the following example the measurement value with index 01 is requested:



#### EXAMPLE

##### Measurement Value cv:

```
#R0000_010cv|AFC2; Answer: #A0000ok_010cv1461 |D34B;
```

##### Storage Value sv:

```
#R0000_010sv|BDF3; Answer: #A0000ok_010sv1461 |9318;
```

### 12.3.6 Sommer Messtechnik CRC-16

The CRC-16 (cyclic redundancy check) used in data transmission of Sommer Messtechnik devices is based on the ZMODEM protocol. When data are exchanged between two devices the receiving device calculates the CRC-value. This value is compared to the CRC value sent by the other device to check if the data were transmitted correctly. Please refer to technical literature or contact Sommer Messtechnik for calculation of CRC-16 values.

You can [here](#) calculate the CRC of a command online .

If you need to compute CRCs automatically, you can implement the following procedure in your data logger or controller software.

The CRC-16 is calculated character by character. The start value for the initial CRC-16 calculation is always 0.

The following procedure returns the CRC-16 of a single character:

```
byte1 = CRC-16 right shift by 8 bits           upper byte disappears
uint1  = c                                     new character, upper byte = 0
uint2  = CRC-16 left shift by 8 bits          lower byte = 0
uint3  = crc16tab[byte1]                      Table value from the CRC-16 table
Crc16  = uint3 (excl. or) uint2 (excl. or) uint1
```

#### Computation CRC-16 in C/C++

```
1 | crc16 = crc16tab[(unsigned char)(crc16>>8)] ^ (crc16<<8) ^ (unsigned int)(c);
```

The `crc16tab` array is listed in [CRC-16 array](#).



**EXAMPLE**

Command to request measurement data `#W0000$pt|4A29;`

The first character is #, the last |. The CRC-16 of the command is 4A29 and its end character is ;.

The CRC-16 is calculated sequentially with the start value 0 for the initial CRC-16 calculation:

Position	String	CRC-16
Start		0000
0	#	0023
1	#W	2357
2	#W0	4331
3	#W00	4997
4	#W000	4EDD
5	#W0001	743B
6	#W0001\$	0537
7	#W0001\$p	67D5
8	#W0001\$pt	C935
9	#W0001\$pt	7D19

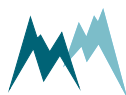

# 13 Configuration of the MRL-8P

The MRL-8P can be configured with one of the following tools:

- Configuration with Commander support software
- Configuration with a terminal program

## 13.1 Configuration with Commander support software

Follow the steps below to modify the configuration parameters of the MRL-8P:

1. Establish a connection between your PC and the MRL-8P.
2. Click **Download parameters from device**. The complete parameter list is transferred from the MRL-8P to your PC and displayed in the Parameter window.

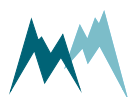
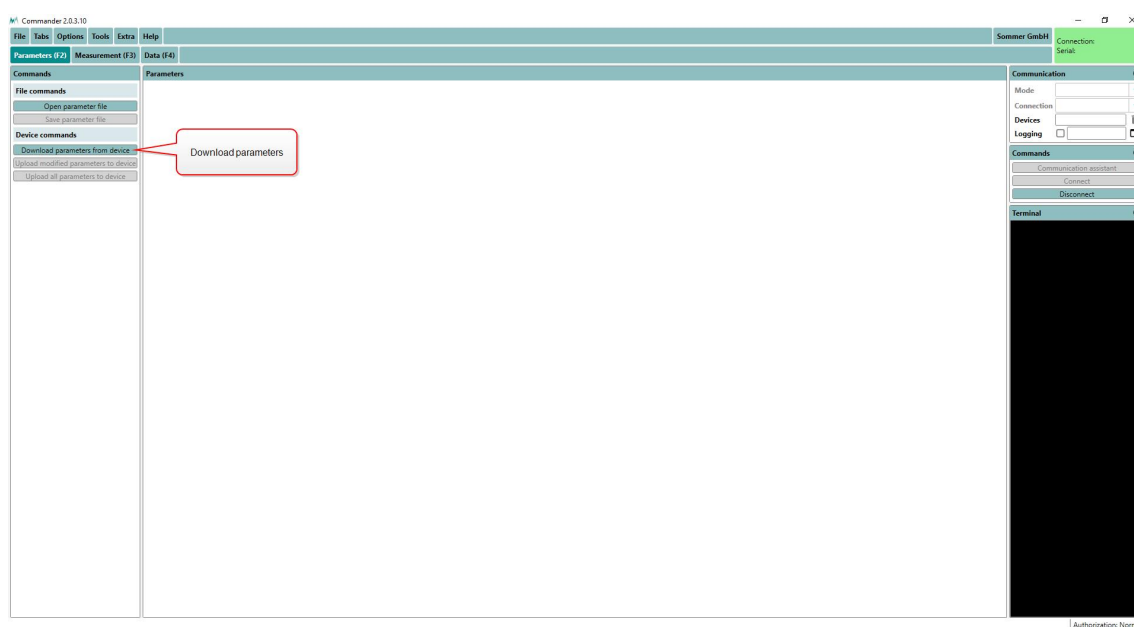



**NOTE** The first download of the parameter list may take a few minutes. After that the device is known to the PC and consecutive downloads are much faster.

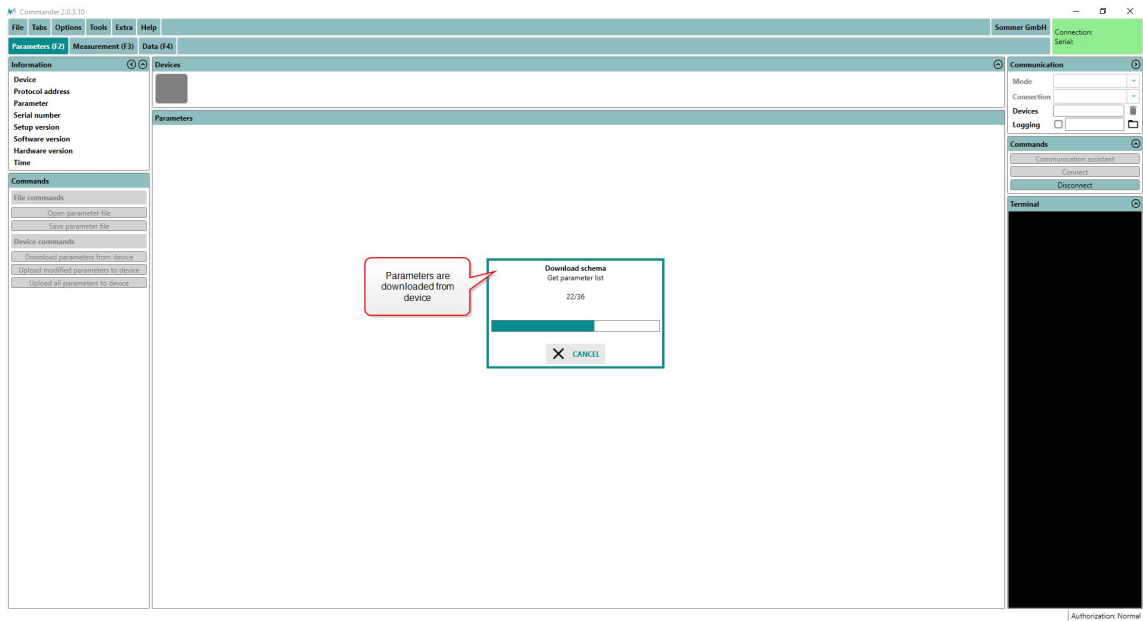

3. Save the parameter file to your PC by clicking **Save parameter file**. This step is recommended to track any configuration changes.

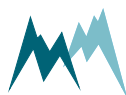
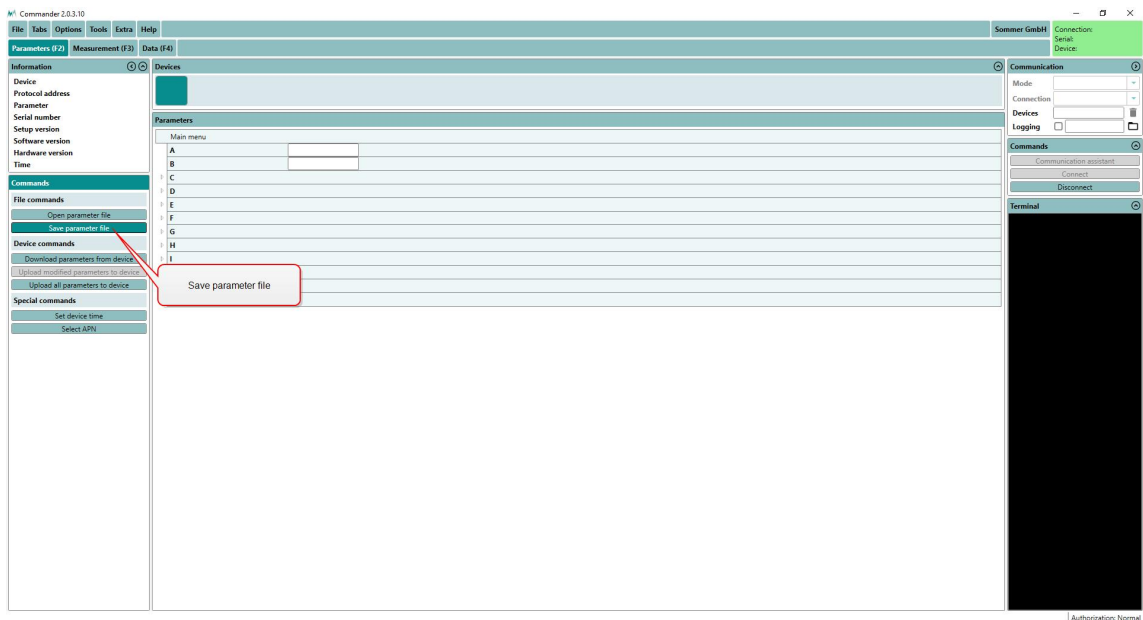

4. Adapt the parameters required for your application. Changed values are displayed with a pink background.

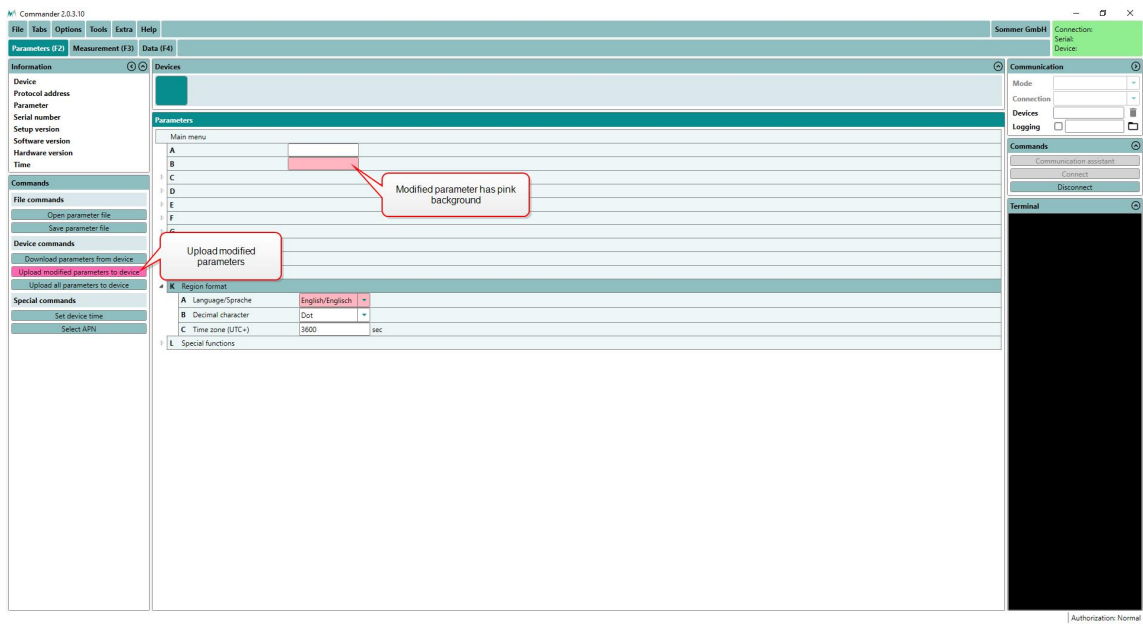

5. Send the modifications to the MRL-8P by clicking **Upload modified parameters to device**. Upon successful upload the pink backgrounds disappear again.



## 13.2 Configuration with a terminal program

The Commander software ships with an integrated terminal program. However, communication with the MRL-8P can be performed with any terminal program.

Follow the steps below to modify the configuration parameters of the MRL-8P:

1. Establish a connection between your PC and the MRL-8P.
2. In the terminal window enter three question marks (???) in quick succession. The main parameter menu is displayed in response.

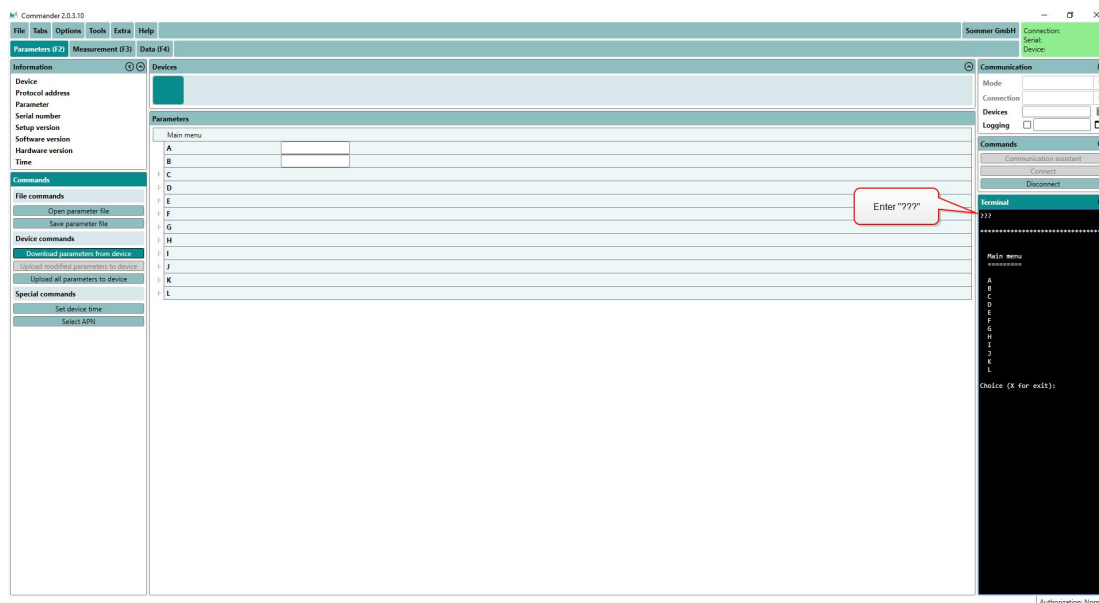

**NOTE** As an unwanted switching into the menu mode must be avoided the timing of the three question marks ??? is very restrictive and must never be finished with Return/Enter. This is especially important for command line tools, which automatically send a closing "Carriage return". Before and after sending ??? no communication must occur for 1 second.

3. Read or modify the required parameters: The menu items can be selected by entering the letter assigned to each item. Upon selection a submenu is opened or the selected parameter is displayed with its unit. Changes to values are confirmed with **Return/Enter** or discarded with **Esc**. Menus are closed with **X** or **Esc**. After closing the main menu with **X** the device performs an initialization.

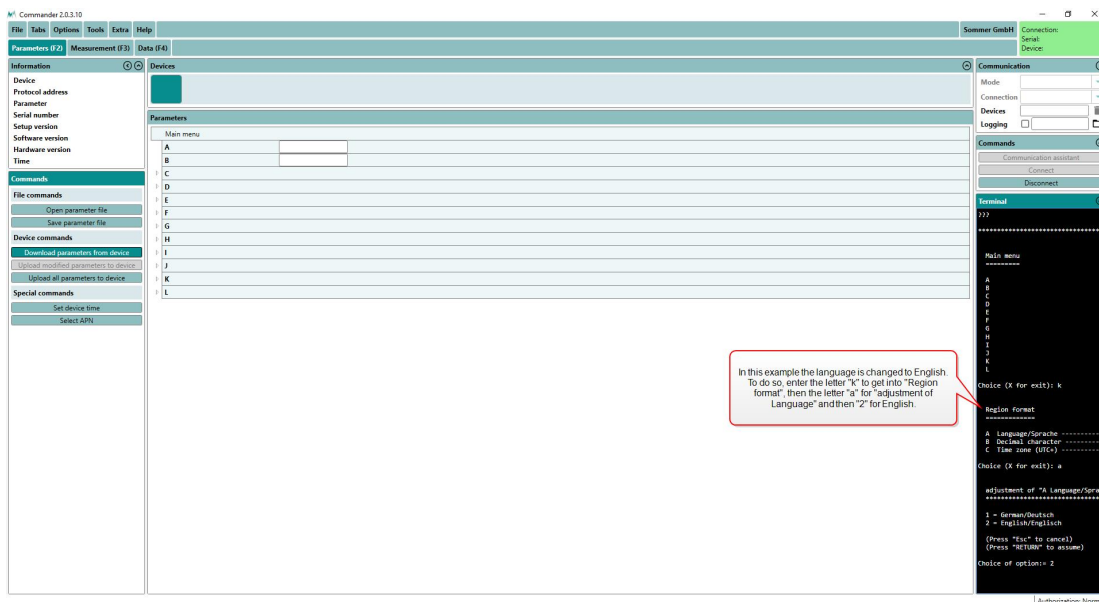

## 13.3 Configuration errors

### 13.3.1 Conflict messages

During configuration with the Commander software, the MRL-8P may return conflict messages after one or more parameters have been changed and uploaded to the device. An example is shown in [Figure 7](#).

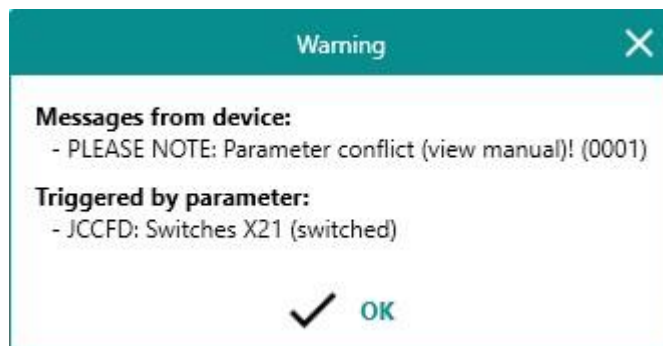
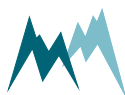

Figure 7 Example of a conflict message



The pop-up window lists the parameters and their indices which have triggered the warning. See [Parameter conflicts](#) for details.



**ATTENTION** If a conflict occurs, invalid settings are replaced automatically with valid values. Verify the values of the conflicting parameters and adapt them if needed!

### 13.3.2 Parameter conflicts

A parameter conflict message as listed below is returned if the value of a parameter conflicts with another parameter setting.

Changed parameter	Affected parameter	Comment
Switch X21, Camera 1 in multiple sub-menus	Switch X21, Camera 1 in multiple sub-menus	If one of the <b>Switches X21</b> is changed, and if this change conflicts with another <b>Switches X21</b> , the older setting is set to <i>off</i> .
Switch X21, Camera 1 in multiple sub-menus or Switches X21 in <b>Messages, table</b>	Switch X21, Camera 1 in multiple sub-menus or Switches X21 in <b>Mes-sages, table</b>	If one of the <b>Switches X21</b> in the <b>Technics</b> menu conflicts with <b>Switches X21</b> in the <b>Mes-sages</b> menu, the intended change is set to <i>off</i> .
<b>Message</b> in <b>Messages, table</b>	<b>Message</b> in <b>Messages, table</b>	If <b>Text</b> is selected, and the MRL-8P is a version without a modem, <b>Message</b> is switched to <i>off</i> .
Identifier or Unit in <b>Measurement table</b>	-	A renamed variable or a change of unit may lead to a mismatch with previously recorded data. The error message <b>0002</b> is displayed.
Measurements, max. number or Aux measurements, max. number	Measurements, max. number or Aux measurements, max. number	The two numbers can only sum up to <b>99</b> . The most recently entered number is trimmed so that the total remains <b>99</b> .

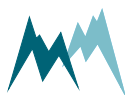

Changed parameter	Affected parameter	Comment
Measurements, max. number or Aux measurements, max. number	All variables in Measurement table	If one or both of the two numbers are reduced, Function in Measurement table is set to <i>off</i> . The other settings of the deactivated variables are preserved.
S-TYP COUNT or WIND in Measurement table	S-TYPCOUNT or WIND in Measurement table	The Wind speed and Counter 2-b inputs are internally connected and can not be used simultaneously. <ul style="list-style-type: none"> <li>■ If a channel has been set to WIND with Speed and another channel is set to COUNT with Counter 2ab, Counter 1 is set instead.</li> <li>■ If a channel has been set to COUNT with Counter 2ab and another channel is set to WIND with Speed, Direct. is set instead.</li> </ul>
Flow control in menu COM	Number of measurement values	If Flow control is set to DFM-RC or DFM-TM, the number of measurement values per string is reduced to 6.
S-TYP SYS and S-MEA Mo-Srv in Measurement table	S-NUM	The MRL-8P provides 4 data transmission tasks. Any number larger than 4 written into S-NUM is altered to 1.
S-TYP SYS and S-MEA X21 in Measurement table	S-NUM	The MRL-8P provides 3 switches on terminal X21. Any number larger than 3 written into S-NUM is altered to 1.
S-TYP SYS and Message in Measurement table	S-NUM	The MRL-8P provides 16 message definitions. Any number larger than 16 written into S-NUM is altered to 1.

Table 12 Parameter conflict messages

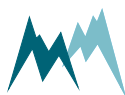

### 13.3.3 Setup conflicts

A setup conflict message as listed below is returned if a modified setup with conflicting parameters is loaded onto the MRL-8P.

Conflict code	Parameter	Comment
0004	Sensor supply (always on) in input menus RS485 or SDI-12 Master and 12V in Analog inputs menu	A serial (RS485 or SDI-12) sensor requires permanent power supply. If Sensor supply (always on) is set to 12 V and 12V is set to Off or Switched, 12V is changed to Always on.
0002	Standby, start time and Standby, duration in menus Time window 1 and Time window 2	Time windows for remote connection cannot overlap. <ul style="list-style-type: none"> <li>■ If Time window 1 embraces Time window 2, Time window 2 is deactivated.</li> <li>■ If Time window 2 embraces Time window 1, Time window 1 adopts Time window 2 and Time window 2 is deactivated.</li> <li>■ If Time window 2 overlaps with Time window 1, Time window 2 is trimmed to start right after Time window 1.</li> <li>■ If Time window 2 starts before Time window 1 and overlaps with Time window 1, Time window 2 is trimmed so that it ends before Time window 1 starts.</li> </ul>

Table 13 Setup conflict messages

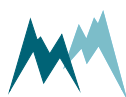

## 13.4 What do I need to configure?

When first setting-up a MRL-8P at a measurement site, the parameters described below may need to be adapted.

### 13.4.1 General settings

#### Station ID

By default, the station ID is set to the MRL-8P serial number. Adjust to your requirements if needed.

#### Station name

The name of the Station (max. 32 characters long).

#### Language/Sprache

The menu language.

#### Decimal character

The character used as decimal separator in the values of the settings, in serial data strings and in .csv files.

#### Measurement interval

The MRL-8P can perform analog, impulse counter and digital measurements at an interval between 2 s and 12 h.



**NOTE** The minimum measurement interval is determined by the duration of the performed measurements. As some time has to be allowed for signal processing, the minimum interval is given as measurement duration plus 1 second.

#### Storage interval

Measurement data can be stored at a primary interval between 10 s and 12 h, specified in [Storage interval](#), or an asynchronous interval between 2 s and 12 h, specified in [Storage interval asynchronous](#). By default, all variables specified in the measurement table are stored in the primary interval. An exception are counter variables, manual entries and some system variables which are stored by default in the secondary interval. By adding the command `SY` or `AS` to the field `S-ADD` of the measurement table, a variable can be forced to be stored in the primary or secondary interval.

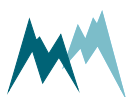



**NOTE** The secondary interval is termed **Storage interval asynchronous** because data are only written to memory if they change. For example, the MRL-8P registers a count after every 100 m<sup>3</sup> of water that has passed through a water channel. As soon as the counter increments by one, the flow data are written to memory.

In the **Function** field of the measurement table you can specify whether the last measurement value or a statistic value, e.g. mean, shall be stored.

### 13.4.2 Measurement table

The data acquired by the MRL-8P are configured in the measurement table. The screenshot below shows an example of a measurement table for an automatic weather station equipped with a combined temperature/humidity sensor, wind speed/direction sensor and a tipping bucket rain gauge.

	Function	Identifier	Unit	Decimals	Scale	Offset			S-TYP	S-NUM	S-MEA	S-ADD
01	Actual	Air temperature	°C	2	100	-40	Adjustment	Test	AIN		An1	
02	Actual	Rel. humidity	%	1	100	0	Adjustment	Test	AIN		An2	
03	Meanval	Wind speed	m/s	2	0,098	0	Adjustment	Test	WIND		Speed	
04	Maximum	Wind speed	m/s	2	0,098	0	Adjustment	Test	WIND		Speed	
05	Meanval	Wind direction	°	1	1,0	0	Adjustment	Test	WIND		Direct.	
06	Actual	Precipitation	mm/h	1	6,0	0	Adjustment	Test	COUNT		Counter 1	
07	Sum	Precip. daily	mm	1	1,0	0	Adjustment	Test	COUNT		Counter 1	SY
08	Actual	Battery voltage	V	1	1,0	0	Adjustment	Test	SYS	0	+Bat V	

The MRL-8P distinguishes between measurement variables and auxiliary measurement variables. The latter are generally used for live monitoring and are not stored on the data logger. For example, the current wind speed could be configured as an auxiliary variable, and the 10-minute average as a regular variable that is stored on the data logger. The number of both variable types can be set in **Measurements, max. number** and **Aux measurements, max. number** and is limited to 99 in total.

Please refer to **Measurement table** for a detailed description of the fields and their options. The configuration of different sensor types is described in section **Data acquisition examples**.

### 13.4.3 Totalizer reset options

Precipitation and discharge measurements, among others, require a totalizer function. For example, in water management it is common to report water discharge as daily totals.

To configure a summed variable with a daily reset, the **Function** field in the measurement table has to be set to **sum** and the **Sum, reset time** has to be set to the required time.

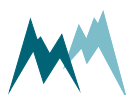

## 13.4.4 Device clock

The clock of the MRL-8P requires regular synchronization. After connection with the Commander software, the time can be set by clicking **Set device time** in the **Parameters (F2)** tab.

Regular time synchronization can be set with the following parameters in menu **Time**:

### Source

The time of the MRL-8P can be synchronized to the sources listed below:

ID	Setting	Description
1	Off	Time synchronization is inactive.
4	NTP (default)	Time is synchronized to a NTP server.

### Timezone

The offset between the time zone in which the MRL-8P is operating and UTC in seconds.



**NOTE** Time synchronization by an NTP server ignores daylight saving time! If automatic time synchronization is active, it removes a manually entered daylight saving time at the next synchronization.

### Synchronization time

The time at which the clock of the MRL-8P is synchronized every day. This time should not overlap with any other communication task of the data logger.



**NOTE** To disable time synchronization set **Source** to *Off* or **Synchronization time** to *24:00:01*.

### NTP server

The address of the time server.

### NTP port

The port of the time server.

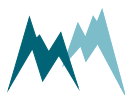

### 13.4.5 Camera

A digital camera with RS-485 communication can be used with the MRL-8P. If connected, it records pictures in the specified [Data transmission interval](#). For automatic operation the following settings have to be configured:

#### Switch X21, Camera 1

The number of the switched supply (X21) which powers the Camera 1.

#### Switch X21, Camera 2

The number of the switched supply (X21) which powers the Camera 2.

#### Warm-up time

The time required by the camera to get ready for recording.

#### Solar nightshutdown

This switch offers the option to shut down the camera during the night. Mostly used to reduce power consumption and data transmission costs. This option requires a connected solar panel to track the night-day cycle by means of the battery voltage.

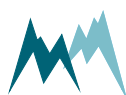

## 14 Data acquisition examples

As listed in [What can I do with it?](#) the MRL-8P accepts a wide range of sensor inputs. In this section the data acquisition of the most common sensor types is described.



**TIP** See [Sensor connections](#) for a complete list of sensor connections.

### 14.1 Power considerations

The MRL-8P provides analog sensor supply of 100 mA at 5 V and 200 mA at 12 V. Extra ports provide 500 mA each at 12 V, in total max. 2 A (at 12 V).



**NOTE** Many digital sensors may require a supply current >200 mA. If such sensors are connected to the MRL-8P, they need to be powered by the extra ports.

### 14.2 Analog measurements

With the MRL-8P single ended voltage signals in the range of 0 to 2.5 V can be measured. The analog inputs [AN3](#) and [AN4](#) can also be configured to measure resistive sensors, e.g. Pt1000.

Option	Description	Terminals
Voltage 2.5	Single ended voltage input 0 ... 2.5 V	AN1 ... AN4
NTC	Measures the temperature of a NTC thermistor	AN3
R meas > 2k	Measures a resistance > 2 k $\Omega$	AN3
Pt1000	Measures the temperature of a Pt1000 temperature sensor	AN4
R meas > 1k2	Measures a resistance > 1.2 k $\Omega$	AN4
R meas < 1k2	Measures a resistance > 0 $\Omega$ (preferably < 1.2 k $\Omega$ )	AN4
Voltage 0.3	Single ended voltage input 0 ... 0.3 V	AN4
Voltage 2.5	Differential voltage input 0 ... 2.5 V	AN4

The signals received from a sensor are wired in the MRL-8P as illustrated in [Figure 8](#).

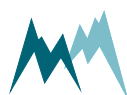

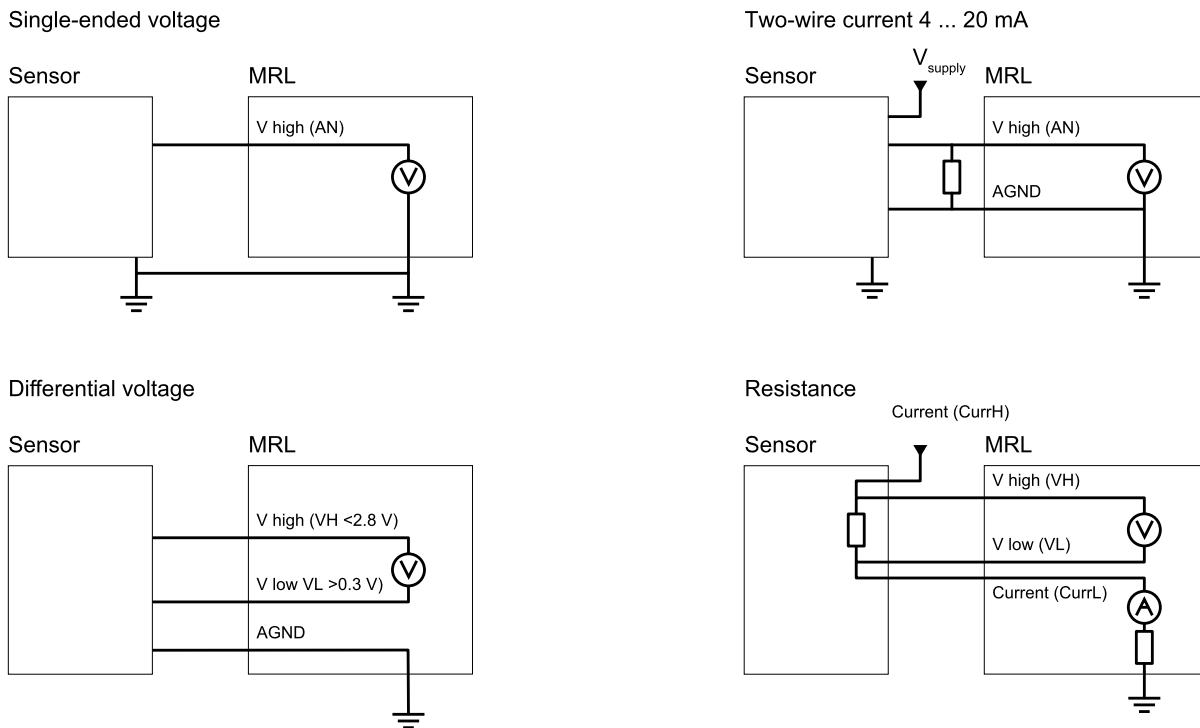

Figure 8 Internal wiring of analog MRL-8P inputs

### 14.2.1 Principals

The illustration below shows a sequence of two measurement cycles of three analog inputs (AN1, AN2 and AN3) and switched power supply.

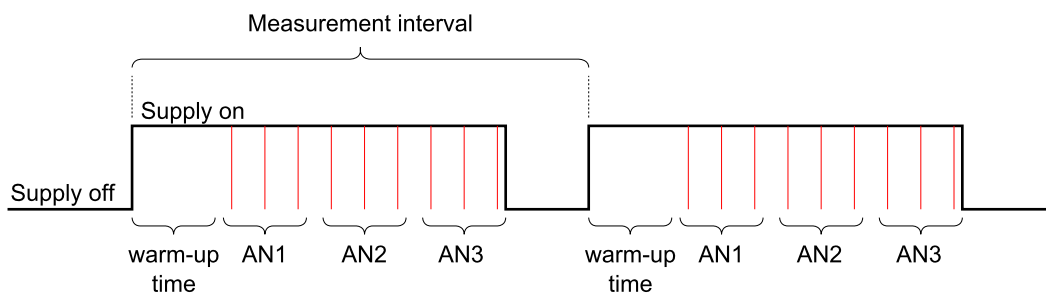
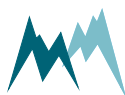

Figure 9 Principal of analog measurements

At the start of each measurement interval the sensor power supply is switched on. After the specified **Warm-up time** each of the three analog inputs is measured sequentially at the sampling rate defined in **ADC - conv. Rate** (red lines). After each measurement has been completed, the sensor power supply is switched off.

If **ADC filter** is active, the input is measured 3 times and the data logger returns the statistic specified in **ADC filter**.



The measurement interval of all sensors is specified in [Measurement interval](#).

## 14.2.2 Analog input assistant

An analog sensor converts the observed quantity into an electrical signal. The data logger reads this signal and converts it back to meaningful values that represent the observed quantity. The Commander provides tools to calculate the conversion from the electrical signal to the observed quantity. This conversion is generally determined by a [Scale](#) and [Offset](#). You can access this tools by opening the Commander, connecting to your MRL-8P and downloading the parameters (see [Support software Commander](#) for instructions on these tasks). Then click on [Analog inputs scaling](#) in the [Tools](#) menu and select the appropriate calculation tool, depending on your input.

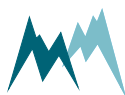
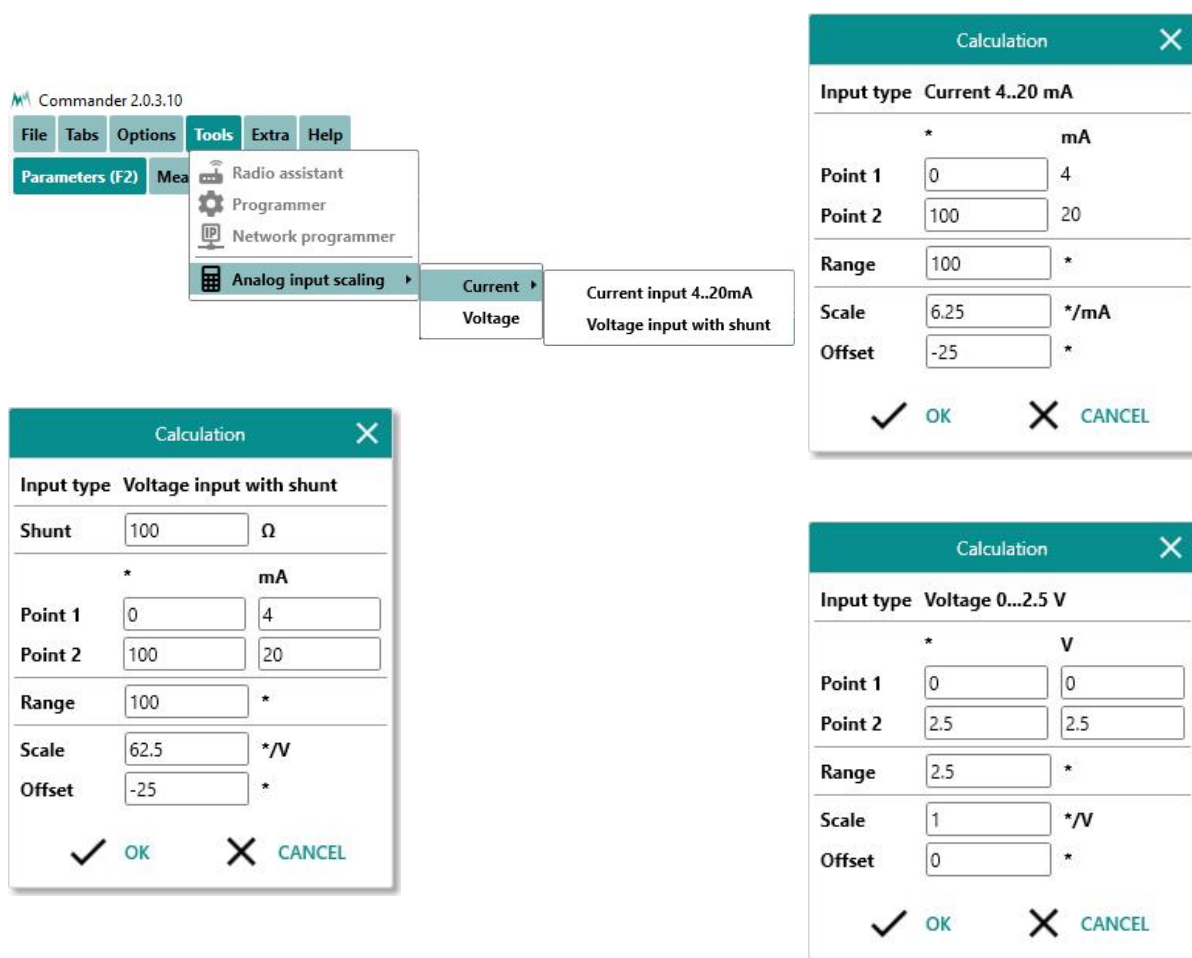

### 14.2.3 Single ended voltage measurement

A total of four single ended voltages can be measured with the MRL-8P. [Figure 10](#) illustrates the wiring of a temperature and relative humidity sensor for single ended measurements with two analog inputs.

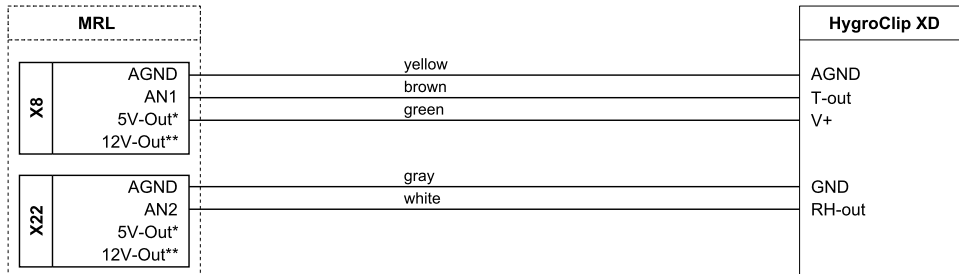

[Figure 10](#) Wiring of a single ended voltage measurement (T/rH-sensor)

The T/rH-sensor in this example can be configured in [Measurement table](#) as follows:

Function	Identifier	Unit	Decimals	Scale	Offset		S-TYP	S-NUM	S-MEA	S-ADD	
01	actual	Air Temperature	°C	2	100	-40	Adjustment	Test	AIN	An1	
02	actual	Rel. Humidity	-	1	100	0	Adjustment	Test	AIN	An2	

### 14.2.4 Differential voltage measurement

The analog input AN4 can also be configured as differential input. The wiring of a pyranometer with a 0...100 mV output is illustrated in [Figure 11](#).

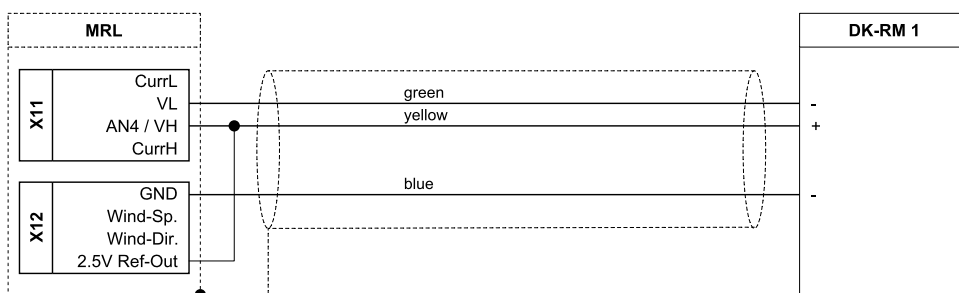

[Figure 11](#) Wiring of differential voltage measurement (pyranometer)

In this example, [AN4 \(D\) type](#) has to be set to Voltage 0.3.

The pyranometer in this example is configured in [Measurement table](#) as follows:



Function	Identifier	Unit	Decimals	Scale	Offset	S-TYP	S-NUM	S-MEA	S-ADD	
01	actual	Global Radiation	W/m <sup>2</sup>	2	125000	0	Adjustment	Test	AIN	An4 (D)

### 14.2.5 Current measurement

By adding a precision shunt resistor to one of the analog voltage inputs, sensors with a current output can be measured. As an example, the wiring of a infrared temperature sensor with an output of 4...20 mA and a measurement range of -50...50 °C is illustrated in Figure 12.

Wiring to AN1 ... AN3:

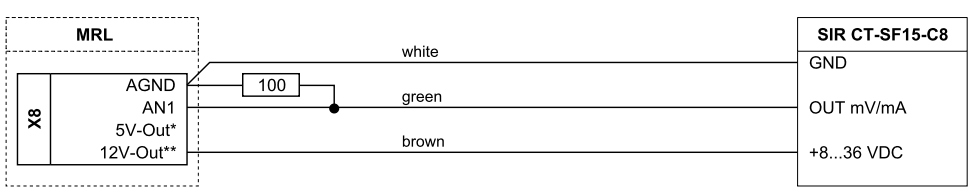

Wiring to AN4:

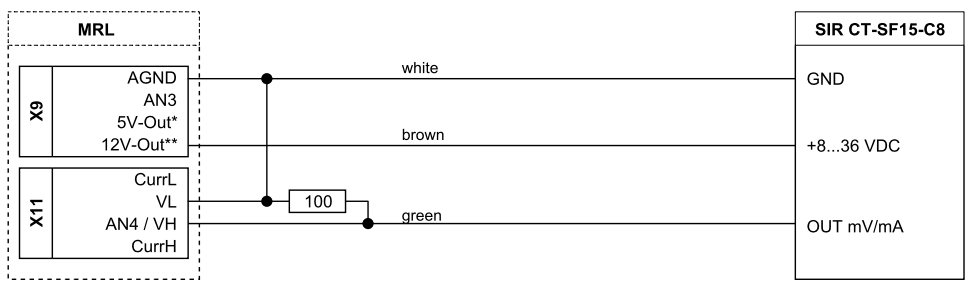

Figure 12 Wiring of sensor with current output (infrared temperature sensor)

If AN4 is used, AN4 (D) type (for X11 only) in the Analog inputs menu has to be set to Voltage 2.5.

The infrared temperature sensor in this example is configured in Measurement table as follows:

Function	Identifier	Unit	Decimals	Scale	Offset	S-TYP	S-NUM	S-MEA	S-ADD	
01	actual	Temperature	°C	2	62.5	-75	Adjustment	Test	AIN	An1

The given Scale and Offset values result from the 4...20 mA sensor output, the measurement range of the sensor and the chosen 100 Ω shunt resistor.



## 14.2.6 Resistance measurement

The analog inputs AN3 and AN4 can be used to measure resistances. As an example, the wiring of a 4-wire Pt1000 temperature sensor is illustrated in [Figure 13](#).

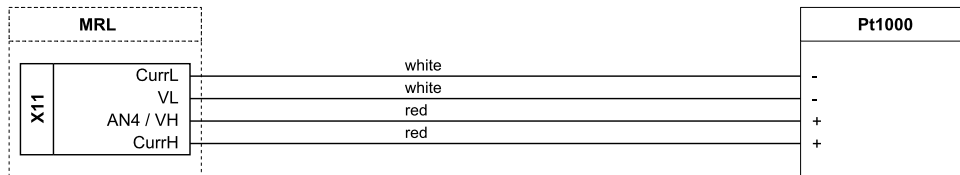

Figure 13 Wiring of resistance measurement (4-wire Pt1000)

In this example, **AN4 (D) type (for X11 only)** in the **Analog inputs** menu has to be set to Voltage 2.5.

The Pt1000 in this example is configured in **Measurement table** as follows:

Function	Identifier	Unit	Decimals	Scale	Offset	S-TYP	S-NUM	S-MEA	S-ADD	
01	actual	Temperature	°C	2	1	0	Adjustment	Test	AIN	An4 (D)

As a Pt1000 sensor is already linearized, **Scale** and **Offset** need not to be changed.

## 14.3 Counter & frequency measurements

The MRL-8P is equipped with three universal counter inputs and one counter input dedicated to wind speed measurements with an anemometer.

### 14.3.1 Counting events

Counter 1 and Counter 2a can be used to record counts from different devices. The combination of Counters 2a and 2b can be used for a shaft encoder.



**NOTE** Depending on your application the position of the dip switches on the data logger board may need to be changed. See [DIP-switches](#) for details.

As an example, the wiring of a tipping bucket rain gauge is illustrated in [Figure 14](#).

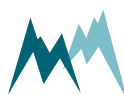
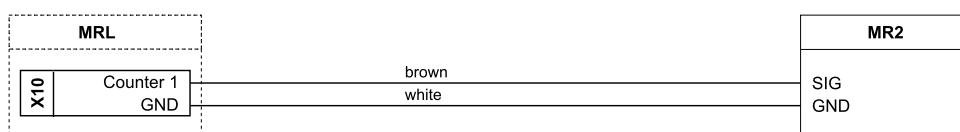

Figure 14 Wiring of a counter input (tipping bucket rain gauge)

The rain gauge in this example is configured in [Measurement table](#) as follows:

	Function	Identifier	Unit	Decimals	Scale	Offset		S-TYP	S-NUM	S-MEA	S-ADD
01	Sum	Precipitation	mm	2	0.2	0	Adjustment	Test	COUNT	Counter 1	

### 14.3.2 Frequency measurement

The wind speed input of the MRL-8P – generally used for wind speed measurements – measures the frequency of an incoming signal. [Figure 15](#) illustrates the wiring of a combined wind speed/direction sensor.

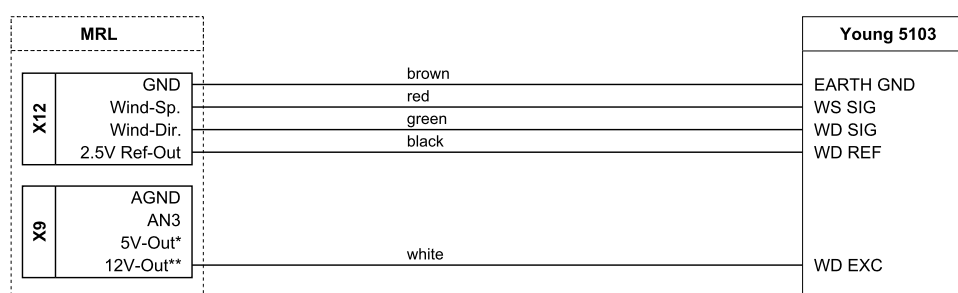

Figure 15 Wiring of a frequency input (combined wind speed/direction sensor)

The wind sensor in this example is configured in [Measurement table](#) as follows:

03	Meanval	Wind speed	m/s	2	0,098	0	Adjustment	Test	WIND	Speed	
04	Maximum	Wind speed max	m/s	2	0,098	0	Adjustment	Test	WIND	Speed	
05	Meanval	Wind direction	°	1	1,44	0	Adjustment	Test	WIND	Direct.	

## 14.4 RS-485

The MRL-8P is equipped with a RS-485 port to acquire sensor measurements.

### 14.4.1 Principles

The example below illustrates the acquisition of measurement values from three digital sensors with the same measurement duration.

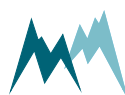

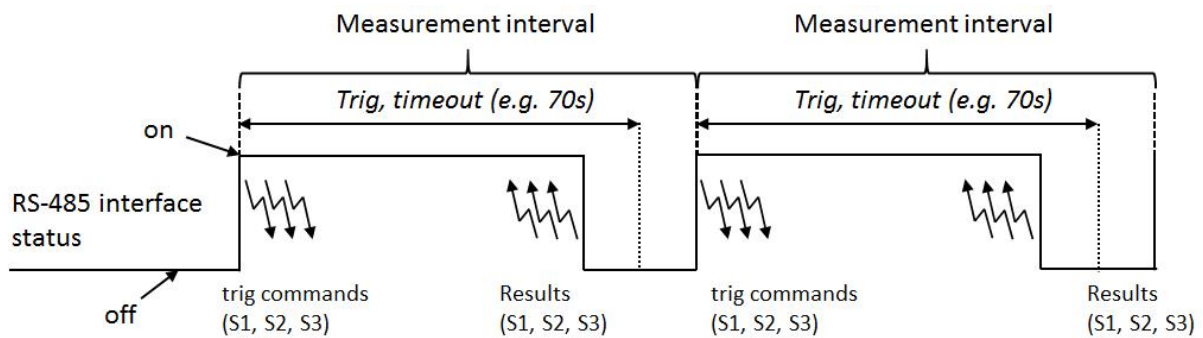

Figure 16 Principal of data acquisition by RS-485

In polling mode the MRL-8P activates the RS-485 interface at the beginning of each measurement interval and sends a measurement command to the addressed sensors. If this command is not confirmed by a sensor it is re-sent a 2<sup>nd</sup> or 3<sup>rd</sup> time. As soon as all measurements have been completed and the requested results have been received within **Timeout**, the RS-485 interface is switched off automatically and remains idle until the next measurement interval.



#### NOTE

If multiple sensors are connected to a MRL-8P, the measurement values must be polled in sequence to avoid data transmission conflicts. To do so, set **Polling delay** to a few seconds. As a result, the MRL-8P waits for the duration of **Polling delay** before it requests the data of the next sensor.

The **Polling delay** and the measurement duration of every sensor must match the duration of **Timeout**. If **Timeout** is too short, the MRL-8P may not receive all measurement values.

For example, sensor one has a measurement duration of 10 seconds, sensor two has a measurement duration of 30 seconds and **Polling delay** is 2 seconds, **Timeout** should be at least  $10 + 2 + 30 = 42$  seconds, plus a few seconds for processing delays.

### 14.4.2 Multiple RS-485 devices

Multiple Sommer Messtechnik sensors can be connected to the RS-485 port of the MRL-8P, provided each digital sensor has a unique address.



**ATTENTION** If multiple Sommer Messtechnik sensors need to be connected, assign a unique address to each device! To do so, connect each sensor individually and set its address.

### 14.4.3 Find RS-485 devices with Commander

The Commander can be used to connect and manage Sommer Messtechnik RS-485 devices connected to the MRL-8P data logger. Follow the steps below to do this:

1. Connect your RS-485 devices to the +RS485A/-RS485B ports of the MRL-8P and make sure all devices are powered.
2. Establish a connection with the MRL-8P as explained in [Connect the MRL-8P to a PC](#).
3. Define a station as describes in [Create a station manually](#).
4. In the **Parameters (F2)** tab download the parameters of the MRL-8P.
5. Set **Enable network scan** to *on*.
6. Make sure the connection to the MRL-8P is not active (no green icon in the top-right corner). In the **Stations (F7)** tab click **Scan devices**. The Commander will now search for all RS-485 devices connected to the data logger and will add them to the station information.

Now, the parameter lists of all devices can be downloaded and the configurations be adapted.

### 14.4.4 Reading data from a Sommer Messtechnik RS-485 device

Various sensing devices perform measurements autonomously and send out the results on request. The SOMMER IDS-20 Ice detection system is an example of such a device. It detects icing of a surface with a capacitive transducer and is used, for example, in the wind industry and in aviation to detect ice loads and icing events.

The IDS-20 performs measurements autonomously at an interval of 60 seconds. The acquired data can be read with the MRL-8P by wiring the data logger according to [Figure 17](#).

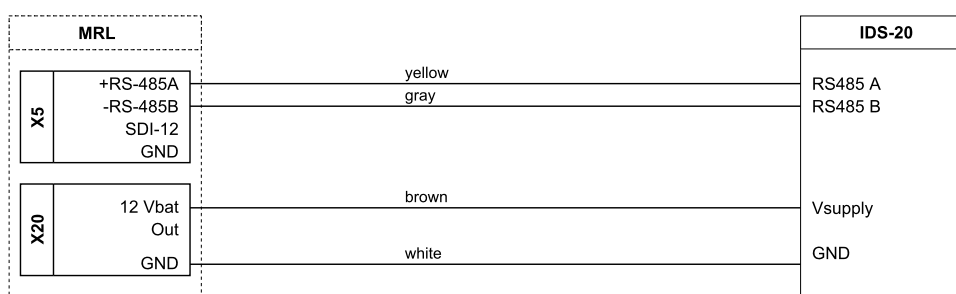

Figure 17 Wiring of IDS-20 ice detection sensor with RS-485 interface

The IDS-20 in this example is configured in [Measurement table](#) as follows:

	Function	Identifier	Unit	Decimals	Scale	Offset		S-TYP	S-NUM	S-MEA	S-ADD
01	actual	Ice	mm	as S		0	Adjustment Test	SBP	1	7	TD
02	actual	Ice rate	mm/h	as S		0	Adjustment Test	SBP	1	9	
03	actual	Dep point	°C	as S		0	Adjustment Test	SBP	1	3	

To poll the data of the sensor, **Polling** must be *Off*. Also, note the command TD (trigger data) in the **S-ADD** field: this command requests the data from the IDS-20 device and needs to be set in the first variable acquired from the sensor.

To match this setup, the **Measurement trigger** of the sensor must be set to *Interval* (if this settings is available), and the **Measurement output** (in sub-menu **RS485 protocol**) to *Just per command*.

Note that in this example only three variables of the IDS-20 are recorded. The device provides an extended list of variables that can be polled by the data logger.



**ATTENTION** The measurement time of different digital sensors varies considerably. Please consult the sensor manual and adjust **Timeout** accordingly! See also Note in **RS-485** above.

### 14.4.5 Trigger measurements of a Sommer Messtechnik RS-485 device

In many applications it is preferred that the MRL-8P triggers the sensor measurements. As an example, the SOMMER SQ-U water discharge sensor can be set into triggered mode. Once it has received the trigger command, the sensor performs the measurement and returns the acquired data to the MRL-8P. The wiring for this example is shown in **Figure 18**.

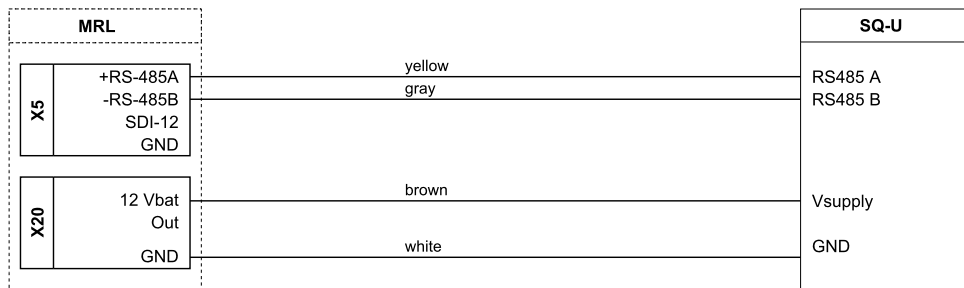

**Figure 18** Wiring of SQ-X water discharge sensor with RS-485 interface

The SQ-U in this example is configured in **Measurement table** as follows:

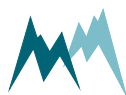

Function	Identifier	Unit	Decimals	Scale	Offset		S-TYP	S-NUM	S-MEA	S-ADD	
01	actual	Water level	m	as S	0	Adjustment	Test	SBP	1	2	
02	actual	Velocity	m/s	as S	0	Adjustment	Test	SBP	1	3	
03	actual	Discharge	m <sup>3</sup> /s	as S	0	Adjustment	Test	SBP	1	5	

Additionally, **Polling** must be set to *On*!

To match this setup, the **Measurement trigger** of the sensor must be set to *SDI-12/RS485*, and the **Measurement output** (in sub-menu *RS485 protocol*) to *After measurement*.

Note that in this example only three variables of the SQ-U are recorded. The device provides an extended list of variables that can be read by the data logger.



**NOTE** Alternatively, the SQ-U can be set to acquire measurements in its own interval. See [Reading data from a Sommer Messtechnik RS-485 device](#) for configuration.

## 14.4.6 Reading data in MIO-format

Some older Sommer Messtechnik sensors like the USH-8 send data in the MIO-format (multi-in-out) which is structured as in the following example:

```
I04124874-011350148960519;
```

	Format	Description
Identifier	I	I identifies an output string
Device number	04	
System key	12	
Measurement value 1	4874	Level in mm (4 digits)
...	...	Measurement values 2...4 (4 digits each)
Checksum		0519
End character		;

To read data strings in MIO-format **Measurement table** has to be configured as follows:

Function	Identifier	Unit	Decimals	Scale	Offset		S-TYP	S-NUM	S-MEA	S-ADD	
01	actual	Level	mm	as S	0	Adjustment	Test	MIO	4	1	

In this example the first measurement value (level) is read from the sensor with device number 04.

**ATTENTION** The system keys of the sensor and the MRL-8P must be the same!  
In the example above the system key is 12. Set **System key** of the MRL-8P to 12 as well, or adapt the key of the sensor.

### 14.4.7 Serial camera

Sommer Messtechnik provides the 2-megapixel serial camera SOMCAM-2S (Art. 21735) for imaging applications. The camera is wired to the MRL-8P according to [Figure 19](#) below.

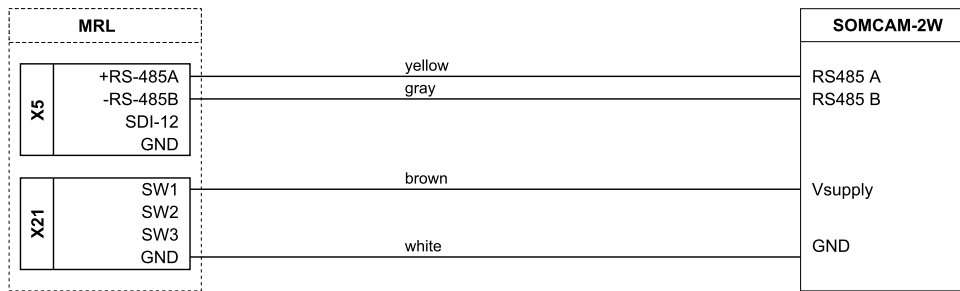

Figure 19 Wiring of serial camera SOMCAM-2

The serial camera of this example is configured in the MRL-8P setup as follows:

D Camera		
<b>A</b>	Switches X21	SW 01 <span style="float: right;">▼</span>
<b>B</b>	Warm-up time	10 <span style="float: right;">sec</span>
<b>C</b>	Solar nightshutdown	Off <span style="float: right;">▼</span>
<b>D</b> <span style="border: 1px solid gray; padding: 2px 5px;">View</span>		

An image can be acquired by clicking the [View](#) button.

To transmit images to a remote server, select *camera* in [Content](#) of one of the data transmission menus.

## 14.5 SDI-12

SDI-12 (Serial Data Interface at 1200 Baud) is a serial data communication standard for interfacing multiple sensors with a single data recorder. The MRL-8P complies with SDI-12 Version 1.3. The MRL-8P is equipped with a SDI-12 port on terminal block X5. [SDI-12 Master](#) offers some helpful

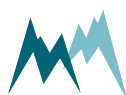

functions to query SDI-12 sensor addresses, to test communication and to handle extended SDI-12 commands.

### 14.5.1 Principles

The example below illustrates how the MRL-8P triggers the measurements and requests the results from three SDI-12 sensors.

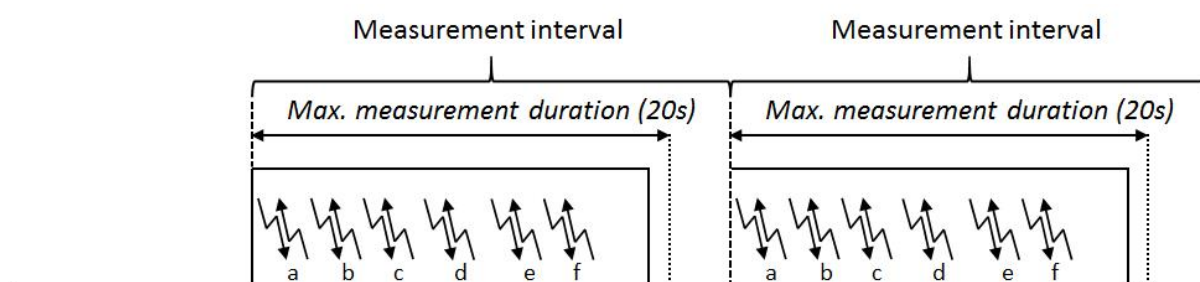

The commands and the received responses are as follows:

1. 0M! Response: 00013<CR><LF> 3 values are available in 1 second
2. 0D0! Response: 0+1.1+2.2+3.3><CR><LF> 3 values: 1.1, 2.2, 3.3
3. 1M! Response: 10022<CR><LF> 2 values are available in 2 seconds
4. 1D0! Response: 1+4.4+5.5><CR><LF> 2 values: 4.4, 5.5
5. 2M! Response: 20031<CR><LF> 1 value is available in 3 seconds
6. 2D0! Response: 2+6.6<CR><LF> 1 value: 6.6

At the beginning of each measurement interval the MRL-8P sends an M! command to the first sensor. The sensor answers by returning the number of available measurements and the measurement duration. After the required measurement time the MRL-8P sends a D! command to request the measurement results. This sequence is repeated for the other two sensors.

The MRL-8P supports all standard SDI-12 commands. See S-ADD in [Measurement table](#) for a full list of these commands. For a detailed description on SDI-12 communication please refer to [www.sdi-12.org](http://www.sdi-12.org).



**TIP** If you need to know more about how to program multiple M! and D! commands please see the example in [Send multiple SDI-12 requests](#).

### 14.5.2 Measurements with an SDI-12 sensor

An SDI-12 sensor is wired to the MRL-8P as shown in [Figure 20](#).

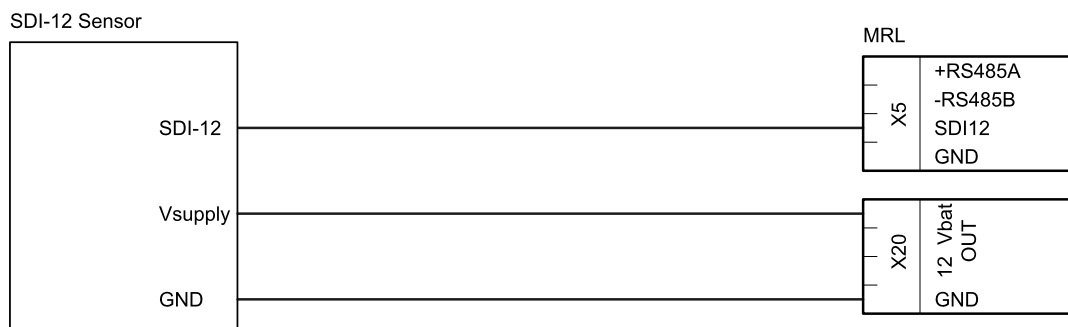

Figure 20 Wiring of a SDI-12 sensor

An SDI-12 sensor is configured in **Measurement table** as in the following example:

	Function	Identifier	Unit	Decimals	Scale	Offset		S-TYP	S-NUM	S-MEA	S-ADD
01	actual	Water Level	m	as S		0	Adjustment Test	SDI12	1	2	
02	actual	Velocity	m/s	as S		0	Adjustment Test	SDI12	1	3	
03	actual	Discharge	m <sup>3</sup> /s	as S		0	Adjustment Test	SDI12	1	5	

To enable data acquisition via SDI-12, **S-TYP** has to be set to *SDI12*, **S-NUM** to the SDI-12 address of the sensor and **S-MEA** to the position of the required measurement value in the data string.

To check the correct wiring between the MRL-8P and SDI-12 sensors, and to request the addresses of these sensors click on **Sensor search** in the **SDI-12 Master** menu. This function then searches for any connected SDI-12 sensors and lists their addresses and identifications. To change a sensor address click **Change sensor address**.



**NOTE**

Please consider that SDI-12 measurements of multiple sensors are performed sequentially. To determine the total measurement time, add the measurement times of all sensors!

Make sure **Max. measurement duration** is long enough to capture the SDI-12 measurements. Be aware that some sensors need long warm-up times, which requires adequate **Max. measurement duration** and an appropriate **Measurement interval**.



**NOTE** The parameter **Max. measurement duration** is important to allow the MRL-8P to switch into power saving mode in case a sensor has a failure.

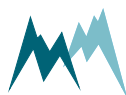

# 15 Parameter definitions

A	Station ID .....	138
B	Station name .....	138
C	Measurement interval .....	138
D	Storage interval .....	139
E	Measurements, max. number .....	139
F	Aux measurements, max. number .....	139
G	Measurement table .....	140
H	Messages, table .....	148
I	Add. intervals .....	153
J	Network .....	156
K	External sat-modem .....	171
L	Technics .....	172
M	Region format .....	198
N	Special functions .....	199

## A Station ID

`mrl-station-id`

By default, the station ID is set to the MRL-8P serial number. Adjust to your requirements if needed.

Value range	Default	Unit
0...99'999'999	XXXXXXXX	-

## B Station name

`mrl-station-name`

The name of the Station (max. 32 characters long).

## C Measurement interval

`generic-measurement-interval`

The interval at which measurements are acquired.

Value range	Default	Units
00:00:02 ... 12:00:00	00:05:00	-

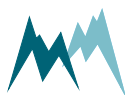

## D Storage interval

mrl-storage-interval

The interval at which acquired measurements are stored in the loggers memory.

Value range	Default	Unit
00:00:02 ... 12:00:00	00:05:00	-

## E Measurements, max. number

mrl-measurements-max-number

The number of variables the MRL-8P records. If the MRL-8P is shipped with additional instruments, SOMMER Messtechnik pre-configures the required variables. The variables are configured in [Measurement table](#) and their number can be increased to 99 (including [Aux measurements, max. number](#))

Value range	Default	Unit
1 ... 99	4	-

## F Aux measurements, max. number

mrl-aux-measurements-max-number

The number of auxiliary variables the MRL-8P records. Auxiliary variables are configured like regular variables, except that they are not stored in memory and are only visible in the Commander [Measurement](#) tab, the terminal window or the logger display. In [Measurement table](#) they are numbered downwards from 99.

Auxiliary variables may be used to monitor limit violations, trigger messages or to display a variable with a second, different unit or a different offset. They are also used to combine different variables to a new one.

Value range	Default	Units
0 ... 98	0	-

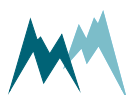

## G Measurement table

### Function

`generic-measurement-table-function`

Defines the output type of the variable. The following options are available:

ID	Function	Description
1	Off	The variable is not recorded and stored.
2	Actual	The last value acquired within the storage interval is recorded and saved.
3	Meanval	The average of all values acquired within the storage interval is recorded and saved.
4	Minimum	The minimum of all values acquired within the storage interval is recorded and saved.
5	Maximum	The maximum of all values acquired within the storage interval is recorded and saved.
6	Sum	The sum of all values acquired within the storage interval is recorded and saved.
7	Intens.	The difference of the last two stored values is saved. If the difference is negative, 0 is returned. Often used for rain intensity measurements.
8	Diff.	The difference of the last two stored values is saved.
9	Custom1	not generally available
10	Custom2	not generally available

### Identifier

`generic-measurement-table-identifier`

User defined variable name. Max. 17 characters long.

### Unit

`generic-measurement-table-unit`

The unit of the selected variable. Max. 7 characters long.

### Decimals

`generic-measurement-table-decimals`

The number of decimal places assigned to the selected variable. The following options are available:

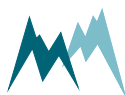

ID	Decimals	Description								
1...5	1...5	number of decimal places assigned to the selected variable								
6	none	no decimal places								
7	as S	<p>For a connected serial sensor the number of decimal places of the sensor output is adopted.</p> <p>For a connected analog sensor the following rules apply:</p> <table border="1"> <thead> <tr> <th>Input type</th> <th>Decimal places</th> </tr> </thead> <tbody> <tr> <td>Voltage, resistance</td> <td>4</td> </tr> <tr> <td>Frequency of wind sensor</td> <td>1</td> </tr> <tr> <td>Direction of wind sensor</td> <td>1</td> </tr> </tbody> </table>	Input type	Decimal places	Voltage, resistance	4	Frequency of wind sensor	1	Direction of wind sensor	1
Input type	Decimal places									
Voltage, resistance	4									
Frequency of wind sensor	1									
Direction of wind sensor	1									

**Scale**`generic-measurement-table-scale`

The slope applied to the selected variable. Only available if **Decimals** is set to 1...5 or none. If **Decimals** is set as S (as source), no scaling is applied.

**Offset**`generic-measurement-table-offset`

The offset applied to the selected variable.

**Adjustment**`generic-measurement-table-adjustment`

A measurement of the selected variable is triggered and the result displayed in a terminal window. If the measured value deviates from the correct value, the correct value can be entered. This adjusts the value in **Offset**. The factor in **Scale** is not affected by this correction.

**Test**`generic-measurement-table-test`



A measurement of the selected variable is triggered and the result displayed in a terminal window.

**S-TYP**`generic-measurement-table-s-typ`

One of the following sensor (or source) types:

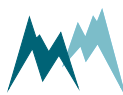
S-TYP	Description and S-MEA options								
AIN	<p>Analog input</p> <p>The input port is set in <b>S-MEA</b> with the following options:</p> <table> <tr> <td>An1</td> <td>Analog input 1</td> </tr> <tr> <td>An2</td> <td>Analog input 2</td> </tr> <tr> <td>An3 (N)</td> <td>Analog input 3</td> </tr> <tr> <td>An4 (D)</td> <td>Analog differential input</td> </tr> </table>	An1	Analog input 1	An2	Analog input 2	An3 (N)	Analog input 3	An4 (D)	Analog differential input
An1	Analog input 1								
An2	Analog input 2								
An3 (N)	Analog input 3								
An4 (D)	Analog differential input								
WIND	<p>Wind sensor</p> <p>The input is set in <b>S-MEA</b> with the following options:</p> <table> <tr> <td>Speed</td> <td>Wind speed</td> </tr> <tr> <td>Direct.</td> <td>Wind direction</td> </tr> </table>	Speed	Wind speed	Direct.	Wind direction				
Speed	Wind speed								
Direct.	Wind direction								
COUNT	<p>Counter input</p> <table> <tr> <td>Counter 1</td> <td>Counter input 1</td> </tr> <tr> <td>Counter 2a</td> <td>Counter input 2</td> </tr> <tr> <td>Counter 2ab</td> <td>Counter input 2-a and 2-b for shaft encoder</td> </tr> </table> <p>See <a href="#">Counter &amp; frequency measurements</a> for details.</p>	Counter 1	Counter input 1	Counter 2a	Counter input 2	Counter 2ab	Counter input 2-a and 2-b for shaft encoder		
Counter 1	Counter input 1								
Counter 2a	Counter input 2								
Counter 2ab	Counter input 2-a and 2-b for shaft encoder								
SDI12	<p>SDI-12 input</p> <p>The sensor address is set in <b>S-NUM</b>, and the position of the measurement value within the output string is assigned in <b>S-MEA</b>. See <a href="#">SDI-12</a> for details.</p>								
SBP	<p>SOMMER sensor that supports the SBP-protocol (via RS-485)</p> <p>The sensor address is set in <b>S-NUM</b>, and the position of the measurement value within the output string is assigned in <b>S-MEA</b>. See <a href="#">RS-485</a> for details.</p>								
MIO	<p>SOMMER sensor that supports the MIO-protocol (via RS-485)</p> <p>The sensor address is set in <b>S-NUM</b>, and the position of the measurement value within the output string is assigned in <b>S-MEA</b>. See <a href="#">Reading data in MIO-format</a> for details.</p>								



S-TYP	Description and S-MEA options
SYS	<p>System variable</p> <p>The variable is set in <b>S-MEA</b> with the following options:</p> <p>Key A                      Number of times the MRL-8P is activated via its keyboard.</p> <p>Key S                      Number of times the MRL-8P is activated via its keyboard with the special key sequence  + .</p> <p>Manual                    If a value is entered manually over the MRL-8P keyboard.</p> <p>Excp. A                    Diagnostic variable</p> <p>Excp. B                    Diagnostic variable</p> <p>Light                      Ambient light intensity (0...3000 Lux)</p> <p>+Sup V                    Supply voltage</p> <p>+Bat V                    Voltage of internal battery</p> <p>5V sup                    Voltage of internal 5V bus supply</p> <p>Mo CSQ                    Modem signal strength</p> <p>Mo excp.                    Modem exception message to monitor data transmission.</p> <p>Mo srv                    Modem data server response, the number of <b>Data transmission</b> is set in <b>S-NUM</b>.</p> <p>Switch                    Status of switch that is to be recorded. The switch number is set in <b>S-NUM</b>.</p> <p>Message                    Number of successful message transmissions since the last storage event. The message number defined in <b>Measurement table</b> must be entered in <b>S-NUM</b>.</p> <p>HB                         Heartbeat changes its value each passing of a storage interval between 0 and 1.</p>
RECYC	Performs an operation on the variable referenced in <b>S-NUM</b> and returns its result. See <b>S-ADD</b> for available operations.
RECYCM	Performs a mathematical operation between two variables referenced in <b>S-NUM</b> and <b>S-MES</b> , and returns its result. See <b>S-ADD</b> for available functions.

**S-NUM**

`generic-measurement-table-s-num`

This setting depends on the selection of **S-TYP**. For example, if **S-TYP** is set to **SDI12**, **S-NUM** sets the SDI-12 address of the connected sensor.

**S-MEA**

`generic-measurement-table-s-mea`

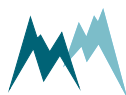

This setting depends on the selection of **S-TYP**. For example, if **S-TYP** is set to *SDI12*, **S-MEA** sets the position of the measurement variable within the SDI-12 string. See **S-TYP** for all available options.

S-TYP	S-NUM	S-MEA	Usage
SBP	Sensor address (0...99)	Position of variable in received data string (0...99).	Read value of digital sensor using SBP protocol.
MIO	String number (0...63)	Position of variable in received data string (0...3).	Read value of digital sensor using MIO protocol.
SDI12	Sensor address (0...61)	Position of variable in received data string (1...99).	Read value of SDI-12 sensor.
RECYC	Measurement ID (1...99)	-	See table in <b>S-ADD</b> .
RECYCM	Measurement ID (1...99)	Measurement ID (1...99)	See table in <b>S-ADD</b> .
SYS	Number of switch (1...3)	X21	Status of one of the X21 switches that is to be recorded.
SYS	Number of messages (1...16)	Message	Number of successful message transmissions since the last storage event.
SYS	0...2	Mo-CSQ	CSQ Value Net type Foreign operator mcc&mnc

### S-ADD

`generic-measurement-table-s-add`

Contains additional commands which are sent with a standard request to a sensor (or source), or which provide additional options for controlling measurements and handling results. The available commands depend on the settings of **Function**, **S-TYP** and **S-ADD**.

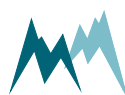

Function	S-TYP	S-ADD	Description
SUM	all	DD	Double data for summed variables at reset event; old and new values are stored.
SUM	all	MR	Monthly reset of summed variables, the reset time is set in <b>Sum, reset time</b> , the day is set in <b>Monthly event, day of month</b> .
SUM	all	NR	No reset of summed variables at defined reset event.
SUM	all	TR	Threshold reset: for summed variables with <b>Limit</b> ; sum is reduced by <b>Limit</b> after a limit violation.
all	all	AS	Asynchronous storage: variable that is normally stored synchronously is stored in the <b>Storage interval asynchronous</b> , i.e. it is only stored if the variable changes its value.
all	all	SY	Synchronous storage: variable that is normally stored asynchronously is stored in the main storage interval, e.g. a counter input.
all	all	SA	Storage of the measured value in the “Storage interval” and in case of prior changes at the “ <b>Storage interval asynchronous</b> ”.
all	all	PV	Values are returned on serial port RS-485-2 immediately after measurement. This may be used to send measurement values to another serial sensor as input.
all	all	ST	Triggers an action if the measurement value is <b>Smaller Than</b> the specified limit set in <b>Limit</b> .
all	all	PS	Converts the measurement interval into seconds (PS), minutes (PM), hours (PH) and days (PD) and multiplies it with the value of the variable. Generally used to calculate differences and intensities.
all	all	PM	For example, a sensor returns a flow rate with the unit m <sup>3</sup> /s. To return the total flow, set <b>Function</b> to <b>Sum</b> , the <b>Unit</b> to <b>m<sup>3</sup></b> and <b>S-ADD</b> to <b>PS</b> . Here, the measurement interval is converted into seconds, multiplied with the measurement value and added to the flow.
all	all	PH	
all	all	PD	ATTENTION: Select the time unit that matches the unit of the variable!

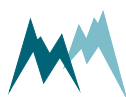

Function	S-TYP	S-ADD	Description
all	all	VA	Converts the value by interpolation with data of <a href="#">Conversion table A</a> , i.e. the value is interpolated by data of column <b>X</b> and the corresponding value of column <b>Y</b> is returned.
all	all	VB	Converts the value by interpolation with data of <a href="#">Conversion table B</a> , i.e. the value is interpolated by data of column <b>X</b> and the corresponding value of column <b>Y</b> is returned.
all	all	NH	No Hysteresis; is only considered when the channel has a limit entered: When the limit has been violated, the limit status stays active no longer than until the next <a href="#">Storage interval</a> and would re-trigger again. If <a href="#">min Hold on</a> is lower than <a href="#">Storage interval</a> this option has no consequence.
all	all	PC	Prevent Camera; is only considered when the channel has a limit entered and <a href="#">a image transmission</a> is active: As long as there is a limit violation (mind the <a href="#">min Hold on</a> setting) no images are transmitted.
all	all	SXn	<a href="#">Secondary storage interval</a> entry n is used for this variable.
all	SDI12	_Cn	Concurrent measurement command for measurements n ( <a href="#">_C1</a> .... <a href="#">_C9</a> ).
all	SDI12	CCn	Concurrent measurement command with CRC for measurements n ( <a href="#">CC</a> .... <a href="#">CC9</a> ).
all	SDI12	_Mn	Measurement command for measurements n, ( <a href="#">_M1</a> .... <a href="#">_M9</a> ).
all	SDI12	MCn	Measurement command with CRC for measurements n, ( <a href="#">MC</a> .... <a href="#">MC9</a> ).
all	SDI12	_Rn	Read command for measurements n, ( <a href="#">_R0</a> .... <a href="#">_R9</a> ).
all	SDI12	RCn	Read command with CRC for data n, ( <a href="#">RC0</a> .... <a href="#">RC9</a> ).
all	SDI12	RD	Reads disdrometer data of Sommer Messtechnik RHD sensor.

Function	S-TYP	S-ADD	Description
all	SDI12	HD	Reads disdrometer data of Sommer Messtechnik HDI sensor.
all	SDI12	VLx	Setting the limit between valid and invalid measured values; as soon as the measured value reaches the number of x digits of 9 or higher, the measurement is considered invalid.
all	SDI12	VK	If a received measurement value is invalid due to the setting of VLx, the old measurement value is retained.
all	SBP, MIO	SCx	Sub-channel x for MDL compatibility.
all	SBP, MIO	TD	Trigger data output of most recent measurement values of SBP or MIO device.
all	SBP	TS	Trigger data output of most recent data records of a MRL-8P.
all	MIO	TF	Trigger fake. In MIO protocol ID's are often only string ID's and not real device ID's. TF marks the real device ID's.
all	COUNT	HL	High/Low. storage of the state at the Counter Input at the time of storage/measurement.
all	COUNT	SW	Switched direction of shaft/impuls encoder.
all	RECYC	GS	Returns the limit status of the variable referenced in S-NUM. If the limit has been violated 1 is returned.
all	RECYCM	D+	Adds variables referenced in S-NUM and S-MEA.
all	RECYCM	D-	Subtracts variable referenced in S-MEA from S-NUM.
all	RECYCM	D*	Multiplies variables referenced in S-NUM and S-MEA.
all	RECYCM	D/	Divides variable referenced in S-NUM by S-MEA.

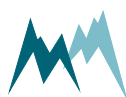

Function	S-TYP	S-ADD	Description
all	RECYCM	EX	Returns exponential of variable referenced in <b>S- NUM</b> (power to basis $e$ ).
all	RECYCM	PT $y$ . $y$	Returns potential of variable referenced in <b>S- NUM</b> to the power of $y$ . $y$ , e.g. a value of <b>2</b> with func- tion PT3.0 returns $2^3 = 8$ .
all	RECYCM	DM	Returns the value of the variable referenced in <b>S- MEA</b> at the maximum or minimum of the variable referenced in <b>S- NUM</b> . Generally used to record the wind directions of wind gusts ( <b>Direction Maximum</b> ).



**TIP** Multiple commands can be entered by separating them with a space, e.g. D+ SY.

### Limit

`generic-measurement-table-limit`

Optional limit value. By default, the measurement value must exceed the limit to trigger an action. Add the command **ST** in **S-ADD** to trigger an action if the measurement value falls below the limit. The value is not allowed to have more than one more number of digits after the decimal point as the input value.

### Messages

`generic-measurement-table-messages`

The action to be performed if the measurement value exceeds or falls below the limit set in **Limit**. The actions are specified in **Messages, table** and are referenced by their message number. Multiple actions can be selected.

## H Messages, table

H-A	Min. Hold on message .....	149
H-B	Max. Hold on message .....	149
H-C	E-mail/SMTP .....	150
	H-C-A E-mail/SMTP .....	150
	H-C-B Sender .....	150
	H-C-C Username .....	150
	H-C-D Password .....	151
	H-C-E Port .....	151
	H-C-F SSL/TLS .....	151
H-D	Messages, table .....	151

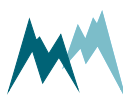

## H-A Min. Hold on message

mrl-min-hold-on-message

The time, after a limit violation, for which a message or switch action is valid. For example, if a value of five minutes is entered, and a measurement value violates a limit value within these five minutes, no message is sent. Used to suppress multiple messages if variable fluctuates around a limit value.

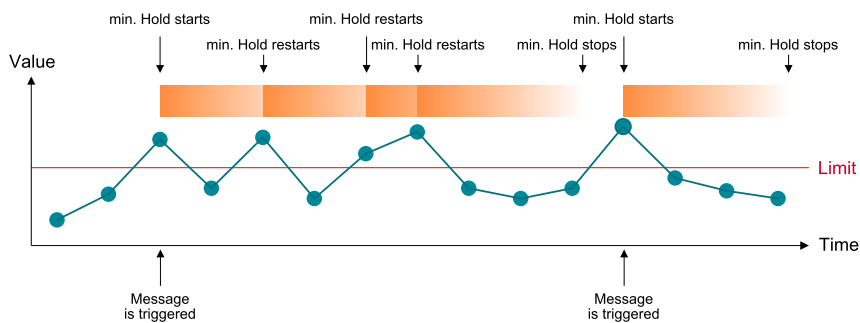

Value range	Default	Unit
0 ... 180	11	min

## H-B Max. Hold on message

mrl-max-hold-on-message

The time over which a limit has to be violated before another message is sent. If, for example, a value of 60 minutes is entered, and the measurement value permanently violates a limit value even after 60 minutes, another message is sent.

A value of zero deactivates this function. This means that no repeated messages are triggered as long as the measurement value is permanently violated.

Case 1: Time of **max. Hold on message** runs out as the value permanently exceeds the limit:

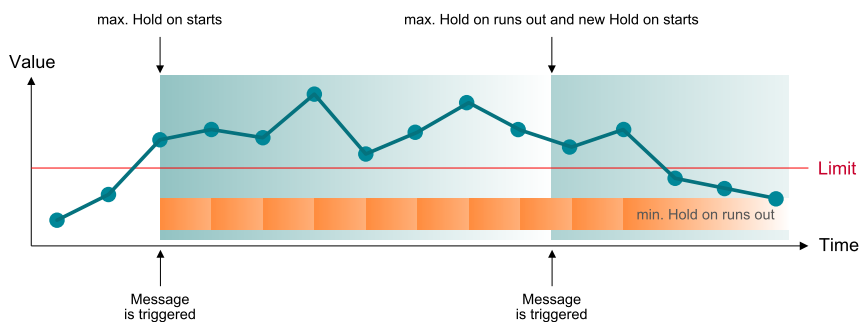

Case 2: A new violation occurs within the time of **max. Hold on message**:

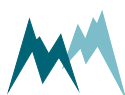

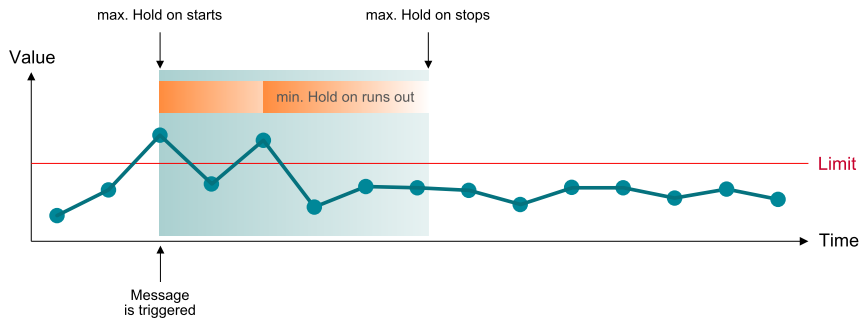

Value range	Default	Unit
0 ... 240	0	min

## H-C E-mail/SMTP

H-C-A	E-mail/SMTP .....	150
H-C-B	Sender .....	150
H-C-C	Username .....	150
H-C-D	Password .....	151
H-C-E	Port .....	151
H-C-F	SSL/TLS .....	151

### H-C-A E-mail/SMTP

`mrl-email-smtp`

The name or address of the outgoing E-Mail server used by the MRL-8P to send e-mails, e.g. *smtp.p.emailprovider.com*.

### H-C-B Sender

`mrl-sender`

E-mail address of the MRL-8P, e.g. *sender.name@emailprovider.com*.

### H-C-C Username

`mrl-username`

Username of your e-mail server account (if requested by the server). Max. 40 characters long.



## H-C-D Password

mrl-password

Password of your e-mail server account (if requested by the server). Max. 40 characters long.

## H-C-E Port

mrl-port

The e-mail server port. Default is [25](#).

## H-C-F SSL/TLS

mrl-network-ssl-tls

ID	Setting	Description
1	Off (default)	Unsecured communication
2	On	SSL/TLS encryption for SMTP communication



**ATTENTION** Normally the port for a secure communication is not [25](#) but [587](#) or [465](#).

## H-D Messages, table

mrl-messages-table

The MRL-8P features a configurable messaging system. Messages are transmitted to defined recipients whenever a measurement value exceeds or falls below a limit specified in [Measurement table](#).

In the messages table up to 16 messages can be configured. Each entry is configured by the parameters described below.

### Message

mrl-messages-table-message

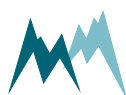

Defines the type of the message. The following options are available:

ID	Message	Description
1	Off	No message is sent.
2	Switch	A switch output is closed if a trigger condition is satisfied.
3	E-Mail	An E-mail is sent to a defined recipient if the trigger condition is satisfied.
4	Text	A SMS message is sent to a defined recipient if the trigger condition is satisfied.

### Recipient

`mrl-messages-table-recipient`

Either the E-mail address or the phone number of the recipient. Country codes of phone numbers are preceded either by 00 or +, e.g. 0049 or +49 for Germany.

### Subject

`mrl-messages-table-subject`

Subject of the e-mail message, max. 80 characters long. The subject may include content codes as listed in the table below.

### Content

`mrl-messages-table-content`

The content of the e-mail or SMS message, max. 160 characters long. The content may include content codes as listed in table below.

### Switches X21

`mrl-messages-table-switch`

The switch output of terminal X21 to be used. Up to three outputs can be selected (SW 01, SW 02, SW 03).

### Hold

`mrl-messages-table-hold`

The time in seconds the selected switch is closed  $\triangleq$  high  $\triangleq$  active after a limit violation has occurred. If 0 seconds is entered, the switch is closed as long as the limit value is violated.

Code	Description
<code>%sid%</code>	Station ID assigned to the MRL-8P
<code>%sname%</code>	Station name assigned to the MRL-8P
<code>%cname%</code>	Name of the channel that triggered the message

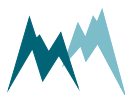

Code	Description
%cunit%	Unit assigned to the channel that triggered the message
%time%	Time of message transmission
%date%	Date of message transmission
%cval%	Last measurement result acquired before message transmission
%tval%	Limit value that was crossed
%rval%	Measurement result that triggered the message
%wnum%	Message number (01...16)
%cp%	Measurement result of a user defined channel.

Content codes



**EXAMPLE**  
 Channel number 02 triggers a message. This message shall contain the channel name and value of the measurement result that triggered the message and additionally the current result of channel number 14. The corresponding message is written as:  
`%cname% %rval% Ch.14 m.value = %cp14%`

## I Add. intervals

Additional interval settings including measurement intervals, storage intervals and intervals for acceleration.

Analog inputs and system values are always measured in the main [Measurement interval](#).

I-A	Measurement interval wind .....	153
I-B	Measurement interval SDI .....	154
I-C	Measurement interval RS485 .....	154
I-D	Secondary storage intervals .....	154
I-E	Interval accel. (SU) .....	155
I-E-A	Measuring and Storage .....	155
I-E-B	Datatransmission .....	155
I-E-C	Picture release .....	155

### I-A Measurement interval wind

MRL-Add-intervals

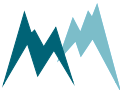

If entered, all measurement values of **S-TYP: WIND** are acquired in this interval. If empty, main interval is used.

Value range	Default	Units
00:00:02 ... 12:00:00	Empty	-

## I-B Measurement interval SDI

MRL-Add-intervals

If entered, all measurement values of **S-TYP: SDI-12** are acquired in this interval. If empty, main interval is used.

Value range	Default	Units
00:00:02 ... 12:00:00	Empty	-

## I-C Measurement interval RS485

MRL-Add-intervals

If entered, all measurement values of **S-TYP: SBP, MIO** and **EXT** are acquired in this interval. If empty, main interval is used.

Value range	Default	Units
00:00:02 ... 12:00:00	Empty	-

## I-D Secondary storage intervals

MRL-Add-intervals

Individual entries for deviant storage intervals. They are applicable per measurement variable in the **S-ADD** field and named **SX<sub>n</sub>** where **n** is the row number of the interval.

Storage interval
The interval applied to the selected variable

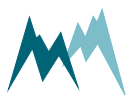

## I-E Interval accel. (SU)

Shorter intervals in case of a limit violation of a measurement variable configured with **S-ADD SU**. If original interval is already shorter, it is not changed. If empty, the affected intervals remain unchanged.

I-E-A	Measuring and Storage .....	155
I-E-B	Datatransmission .....	155
I-E-C	Picture release .....	155

### I-E-A Measuring and Storage

MRL-Add-intervals

Interval used for measuring (of all types) and storage (including [Secondary storage intervals](#)).

Value range	Default	Units
00:00:02 ... 12:00:00	Empty	-

### I-E-B Datatransmission

MRL-Add-intervals

Interval used for data transmissions.

Value range	Default	Units
00:01:00 ... 24:00:00	Empty	-

### I-E-C Picture release

MRL-Add-intervals

Interval used for image transmissions.

Value range	Default	Units
00:01:00 ... 24:00:00	Empty	-

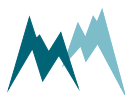

## J Network

J-A	Operation .....	156
J-B	Modem config .....	156
J-C	Ethernet config .....	159
J-D	Data transmission 1 .....	160
J-E	Data transmission 2 .....	164
J-F	Data transmission 3 .....	165
J-G	Data transmission 4 .....	165
J-H	Remote config .....	165
J-I	Time .....	169

### J-A Operation

mrl-modem-functionality

ID	Setting	Description
1	Off (default)	Network connection is inactive.
2	On	Modem and Ethernet connections are active.
3	Modem only	Only mobile modem connection is active.
4	Ethernet only	Only Ethernet connection is active.

### J-B Modem config

J-B-A	SIM pin .....	156
J-B-B	Net type .....	157
J-B-C	Foreign operator mcc&mnc .....	157
J-B-D	Operator select .....	157
J-B-E	APN address .....	158
J-B-F	APN user name .....	158
J-B-G	APN password .....	158
J-B-H	Custom command 1 .....	158
J-B-I	Custom command 2 .....	159

#### J-B-A SIM pin

mrl-sim-pin

The PIN of the SIM card. If the SIM card has been unlocked, enter -1.

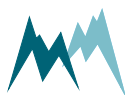

Value range	Default	Unit
-1...999999	-1	-

The PIN cannot be changed with the MRL-8P. Use a different device, e.g. mobile phone, for this task.



**ATTENTION** If the wrong PIN is entered, the MRL-8P will report a PIN error after the first connection attempt and will no longer try to submit the PIN until the data logger is restarted again.

### J-B-B Net type

mrl-net-type

The telecommunication standard used for data transmission.

ID	Setting	Description
1	Auto (default)	The telecommunication network is selected automatically (2G, 3G or 4G).
2	3G	Only 3G telecommunication networks are used to transfer data.
3	2G	Only 2G telecommunication networks are used to transfer data.
4	4G	Only 4G telecommunication networks are used to transfer data.
5	Auto (US + CA)	The telecommunication network is selected automatically. Applies to the US and Canada only (3G or 4G).
6	2G+4G	Only 2G and 4G telecommunication networks are used to transfer data.

### J-B-C Foreign operator mcc&mnc

mrl-foreign-operator-mcc-mnc

The mobile country code (MCC) and mobile network code (MNC) of your home network in case your provider uses a foreign network. If blank, this setting is inactive (default).

### J-B-D Operator select

mrl-operator-select

The network operator to be used.

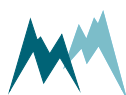

ID	Setting	Description
1	Auto (default)	The network operator is selected automatically.
2	Home	Only the SIM card's home network is used. Recommended in the vicinity of country borders where a foreign network could lead to high roaming costs. <b>Foreign operator mcc&amp;mnc</b> may need to be set.
3	Prefer home	Preferably, the home network of the selected operator is chosen. If no connection can be established with the home network, another operator is selected automatically. <b>Foreign operator mcc&amp;mnc</b> may need to be set.

### J-B-E APN address

`mrl-apn-address`

The APN of your carrier's mobile network. The APN can be selected from a list displayed with **Select APN** in the Commander menu **Special commands**.

### J-B-F APN user name

`mrl-apn-username`

The APN username. Max. 40 characters long.

### J-B-G APN password

`mrl-apn-password`

The APN password. Max. 40 characters long.

### J-B-H Custom command 1

`mrl-custom-command-1`

AT command sent to the modem. These are used to adapt the modem to country or provider specific conditions. The escape characters listed in **Appendix C** may be used.

The prefix **AT** does not need to be entered in the command field.

All AT commands must be answered with an **OK** by the connected modem. Use this function only if you are familiar with AT commands or if meaningful commands have been released by Sommer Messtechnik.

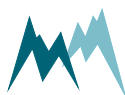

## J-B-I Custom command 2

mrl-custom-command-2

See [Custom command 1](#).

## J-C Ethernet config

J-C-A	Power ext. LAN .....	159
J-C-B	Warm-up ext. LAN .....	159
J-C-C	Power MEE .....	159
J-C-D	Warm-up MEE .....	160
J-C-E	TCP timeout .....	160

### J-C-A Power ext. LAN

mrl-power-lan

Power supply for external Ethernet router or gateway.

ID	Setting	Description
1	off (default)	Power supply is off
2	SW1	Power supply SW1 is used
3	SW2	Power supply SW2 is used
4	SW3	Power supply SW3 is used

### J-C-B Warm-up ext. LAN

mrl-warm-up-lan

Warm-up time for external Ethernet router or gateway.

Value range	Default	Unit
0 ... 400	60	s

### J-C-C Power MEE

mrl-power-mee

Power supply of MRL-8P Ethernet extension.

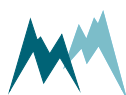

ID	Setting	Description
1	off	Power supply of Ethernet extension is off
2	SW1 (default)	Ethernet extension is powered by SW1
3	SW2	Ethernet extension is powered by SW2
4	SW3	Ethernet extension is powered by SW3

## J-C-D Warm-up MEE

mrl-warm-up-mee

Warm-up time for Ethernet extension.

Value range	Default	Unit
0 ... 400	60	Seconds

## J-C-E TCP timeout

mrltcp-timeout

Timeout on the TCP layer within which the MRL-8P expects an acknowledgment from the data receiver.

Value range	Default	Units
500...5'000	1000	ms

## J-D Data transmission 1

J-D-A	Target server type .....	161
J-D-B	Access .....	161
J-D-C	Data transmission interval .....	161
J-D-D	Data transmission offset .....	162
J-D-E	Content .....	162
J-D-F	FTP server name .....	162
J-D-G	FTP user name .....	163
J-D-H	FTP password .....	163
J-D-I	FTP directory .....	163
J-D-J	FTP port .....	163
J-D-K	FTP mode .....	163
J-D-L	HTTP server name .....	163
J-D-M	HTTP basic authentication .....	164
J-D-N	HTTP basic user name .....	164

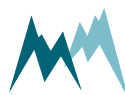

J-D-O	HTTP basic password .....	164
J-D-P	HTTP path .....	164
J-D-Q	HTTP port .....	164

## J-D-A Target server type

`mrl-target-server-type`

The type of server to which the data are sent to.

ID	Setting	Description
1	Off (default)	No data are transmitted.
2	HTTP	Data are sent to a HTTP server (HTTP settings are used)
3	FTP	Data are sent to a FTP server (FTP settings are used)
4	HTTPS	Data are sent to a HTTPS server (HTTP settings are used)
5	FTPS	Data are sent to a FTPS server (FTP settings are used)
6	SFTP+PW	Data are sent to a SFTP server with username and password as login credentials (FTP settings are used) (only if <a href="#">Ethernet connection</a> is active)
7	SFTP+PK	Data are sent to a SFTP server with username and public key file as login credentials (FTP settings are used) (only if <a href="#">Ethernet connection</a> is active)

## J-D-B Access

`mrl-access`

Type of connection used for communication.

ID	Setting	Description
1	Modem	Modem is used for communication.
2	Ethernet	Ethernet is used for communication.

## J-D-C Data transmission interval

`mrl-data-transmission-interval`

The interval in which data are transmitted to the selected server.



Value range	Default	Unit
00:01:00 ... 24:00:00	00:10:00	-

### J-D-D Data transmission offset

`mrl-data-transmission-offset`

The data transmission offset is used to prevent several MRL-8P from sending their data to the same server at the same time. Thus, set different transmission offsets when using several MRL-8P with the same server.

Value range	Default	Unit
00:00:00 ... 23:59:59	00:01:09	-

### J-D-E Content

`mrl-content`

The type of data to be transmitted.

ID	Setting	Description
1	Data (default)	Measurement data are transmitted.
2	Images	Images taken by all connected cameras are transmitted.
3	Image 1	Images taken by first camera are transmitted.
4	Image 2	Images taken by second camera are transmitted.



**ATTENTION** When only one camera is activated, the usage of [option 4](#) is declined and set to [option 2](#)!

### J-D-F FTP server name

`mrl-ftp-server-name`

The FTP name or server address. Max. 80 characters long.

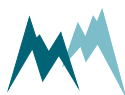

## J-D-G FTP user name

`mrl-ftp-user-name`

The username of your FTP server account. Max. 20 characters long. The escape characters listed in [Appendix C](#) may be used.

## J-D-H FTP password

`mrl-ftp-password`

The password of your FTP server account. Max. 40 characters long. The escape characters listed in [Appendix C](#) may be used.

## J-D-I FTP directory

`mrl-ftp-directory`

The FTP directory where the data are saved. If empty, data are saved to the FTP root directory. The escape characters listed in [Appendix C](#) may be used.

## J-D-J FTP port

`mrl-ftp-port`

The FTP server port. Default is [21](#).

## J-D-K FTP mode

`mrl-ftp-mode`

The FTP server mode.

ID	Setting	Description
1	active	active FTP
2	passive (default)	passive FTP

## J-D-L HTTP server name

`mrl-http-server-name`

The HTTP name or server address. Max. 80 characters long.

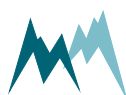

## J-D-M HTTP basic authentication

mrl-network-http-authentication

ID	Setting	Description
1	On	Authentication for the HTTP server is required.
2	Off (default)	Authentication for the HTTP server is not required.

## J-D-N HTTP basic user name

mrl-http-basic-user-name

The username of your HTTP server account. Max. 20 characters long. The escape characters listed in [Appendix C](#) may be used.

## J-D-O HTTP basic password

mrl-http-basic-password

The password of your HTTP server account. Max. 40 characters long. The escape characters listed in [Appendix C](#) may be used.

## J-D-P HTTP path

mrl-http-path

The HTTP request, URL or script by which the data are saved. Max. 80 characters long. The escape characters listed in [Appendix C](#) may be used.

## J-D-Q HTTP port

mrl-http-port

The HTTP server port. Default is **80**.

## J-E Data transmission 2

See [Data transmission 1](#).

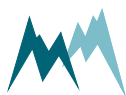

## J-F Data transmission 3

See [Data transmission 1](#).

## J-G Data transmission 4

See [Data transmission 1](#).

## J-H Remote config

J-H-A	IP Call password .....	165
J-H-B	Time window 1 .....	165
J-H-C	Time window 2 .....	167

### J-H-A IP Call password

`mrl-ip-call-password`

The password to access the IP Call server. An arbitrary alphanumeric string max. 15 characters long.

### J-H-B Time window 1

J-H-B-A	Connection .....	165
J-H-B-B	Access .....	166
J-H-B-C	Standby, start time .....	166
J-H-B-D	Standby, duration .....	166
J-H-B-E	IP Call server .....	166
J-H-B-F	IP Call port .....	167
J-H-B-G	IP Call interval .....	167

### J-H-B-A Connection

`mrl-background-function`

Specifies the management of communication requests.



ID	Setting	Description
1	Off	The MRL-8P does not accept remote connections.
2	IP call (default)	The MRL-8P checks periodically for IP call requests in the time window specified by <a href="#">Standby, start time</a> and <a href="#">Standby, duration</a> .
3	Socket	The MRL-8P listens on its IP address with port 4646 for requests in the time window specified by <a href="#">Standby, start time</a> and <a href="#">Standby, duration</a> .

### J-H-B-B Access

`mrl-access`

Type of connection used for communication.

ID	Setting	Description
1	Modem	Modem is used for communication.
2	Ethernet	Ethernet is used for communication.

### J-H-B-C Standby, start time

`mrl-standby-start-time`

The time of day from which the MRL-8P is available for remote communication (IP calls, Socket connections).

Value range	Default	Unit
00:00:00 ... 23:59:59	08:00:00	-

### J-H-B-D Standby, duration

`mrl-standby-duration`

The time for which the MRL-8P is available for remote communication (IP-Calls or Socket requests).

Value range	Default	Unit
00:00:01 ... 23:59:59	01:00:00	-

### J-H-B-E IP Call server

`mrl-ip-call-server`

The name or address of the IP call server. Default is [mds.sommer.at](#).

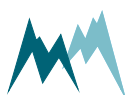

**J-H-B-F IP Call port**

mrl-ip-call-port

The port of the IP call server. Default is 4647.

**J-H-B-G IP Call interval**

mrl-ip-call-interval

The interval at which the MRL-8P checks if there are any IP call requests. These checks are only performed within the time window specified by Standby, start time and Standby, duration.

Value range	Default	Unit
00:01:00 ... 00:05:00	00:01:00	-

**J-H-C Time window 2**

J-H-C-A Connection .....167  
 J-H-C-B Access .....167  
 J-H-C-C Standby, start time .....168  
 J-H-C-D Standby, duration .....168  
 J-H-C-E IP Call server .....168  
 J-H-C-F IP Call port .....168  
 J-H-C-G IP Call interval .....168

**J-H-C-A Connection**

mrl-background-function

Specifies the management of communication requests.

ID	Setting	Description
1	Off	The MRL-8P does not accept remote connections.
2	IP call (default)	The MRL-8P checks periodically for IP call requests in the time window specified by Standby, start time and Standby, duration.
3	Socket	The MRL-8P listens on its IP address with port 4646 for requests in the time window specified by Standby, start time and Standby, duration.

**J-H-C-B Access**

mrl-access

Type of connection used for communication.

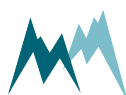

ID	Setting	Description
1	Modem	Modem is used for communication.
2	Ethernet	Ethernet is used for communication.

### J-H-C-C Standby, start time

`mrl-standby-start-time`

The time of day from which the MRL-8P is available for remote communication (IP calls, Socket connections).

Value range	Default	Unit
00:00:00 ... 23:59:59 / empty	empty	-

### J-H-C-D Standby, duration

`mrl-standby-duration`

The time for which the MRL-8P is available for remote communication (IP-Calls or Socket requests).

Value range	Default	Unit
00:00:01 ... 23:59:59 / empty	empty	-

### J-H-C-E IP Call server

`mrl-ip-call-server`

The name or address of the IP call server. Default is [mds.sommer.at](https://www.mds-sommer.at).

### J-H-C-F IP Call port

`mrl-ip-call-port`

The port of the IP call server. Default is [4647](#).

### J-H-C-G IP Call interval

`mrl-ip-call-interval`

The interval at which the MRL-8P checks if there are any IP call requests. These checks are only performed within the time window specified by [Standby, start time](#) and [Standby, duration](#).

Value range	Default	Unit
00:01:00 ... 00:05:00	00:01:00	-

## J-I Time

J-I-A	Source .....	169
J-I-B	Access .....	169
J-I-C	Synchronization time .....	169
J-I-D	NTP server .....	170
J-I-E	NTP port .....	170
J-I-F	Check deviation .....	170
J-I-G	Deviation .....	170

### J-I-A Source

`mrl-time-source`

The time source to which the MRL-8P is synchronized.

ID	Setting	Description
1	Off	Time synchronization is inactive.
4	NTP (default)	Time is synchronized to a NTP server.

### J-I-B Access

`mrl-access`

Type of connection used for communication.

ID	Setting	Description
1	Modem	Modem is used for communication.
2	Ethernet	Ethernet is used for communication.

### J-I-C Synchronization time

`mrl-synchronization-time`

The time at which the clock of the MRL-8P is synchronized.

Value range	Default	Unit
00:00:00 ... 23:59:59	02:08:43	-



## J-I-D NTP server

`mrl-ntp-server`

The address of the NTP server. Default is [at.pool.ntp.org](https://at.pool.ntp.org).

## J-I-E NTP port

`mrl-ntp-port`

The NTP port of the NTP server. Default is 123.

## J-I-F Check deviation

`mrl-deviation-check`

Optional check of the time retrieved via NTP for excessive deviation from the own logger time; this can be used to intercept faulty/manipulated time servers.

Value	Setting	Description
1	Off	no test
2	Early	if new time is more than the value of <b>Deviation</b> earlier than logger time, the current logger time will not be changed
3	Late	if new time is more than the value of <b>Deviation</b> later than logger time, the current logger time will not be changed
4	Both	if new time is more than the value of <b>Deviation</b> in both directions away from the logger time, the current logger time will not be changed

## J-I-G Deviation

`mrl-deviation`

Maximum allowed deviation of NTP time from own logger time; in minutes

Value range	Default	Unit
1 ... 10080	10080	min



## K External sat-modem

K-A	Use .....	171
K-B	Data transmission interval .....	171
K-C	Data transmission offset .....	171
K-D	Data coupling .....	171

### K-A Use

MRL-Sat-modem

ID	Setting	Description
1	Off (default)	Not in use.
2	On	Satellite modem assumed to be connected and active.

### K-B Data transmission interval

MRL-Sat-modem

The interval in which data are transmitted to the selected server.

Value range	Default	Units
00:10:00 ... 24:00:00	01:00:00	-

### K-C Data transmission offset

MRL-Sat-modem

The data transmission offset is to adjust the time to be after data storage and after a modem transmission in case of data coupling.

Value range	Default	Units
00:00:00 ... 23:59:59	00:06:00	-

### K-D Data coupling

MRL-Sat-modem

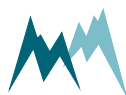

To keep satellite data costs low, it is possible to share the last sent data with a [Operation](#) so that only in case of a broken network data is sent over satellite.

ID	Setting	Description
1	Off (default)	Send all available data over satellite.
2	Transmission 1	Send only data that has not yet been transmitted by transmission 1.
3	Transmission 2	Send only data that has not yet been transmitted by transmission 2.
4	Transmission 3	Send only data that has not yet been transmitted by transmission 3.
5	Transmission 4	Send only data that has not yet been transmitted by transmission 4.

## L Technics

L-A	SBP device addressing .....	172
L-B	COM .....	173
L-C	Inputs .....	177
L-D	Additional settings .....	195

### L-A SBP device addressing

L-A-A	Device number .....	172
L-A-B	System key .....	172
L-A-C	Enable network scan .....	173

#### L-A-A Device number

`generic-rs-485-protocol-device-number`

The device number is used for the unique identification of the device in a bus system.

Value range	Default	Units
0...98	0 (default)	-

#### L-A-B System key

`generic-rs-485-protocol-system-key`

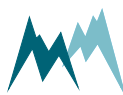

The system key defines the bus system of the device. Thus, different conceptual bus systems can be separated. Interfering bus systems occur if the remote radio coverage of two measurement systems overlap. In general, the system key should be set to 00.

Value range	Default	Units
0...99	0	-

### L-A-C Enable network scan

`generic-rs-485-port-network-scan-extension`

Optional detection of connected SOMMER sensors with the Commander software.

ID	Setting	Description
1	No	Detection of SOMMER devices connected to RS485 A/B is deactivated.
2	Yes (default)	Detection of SOMMER devices connected to RS485 A/B is activated.

## L-B COM

L-B-A	Output protocol .....	173
L-B-B	Port .....	175

### L-B-A Output protocol

L-B-A-A	Protocol type .....	173
L-B-A-B	Measurement output .....	174
L-B-A-C	Information .....	174
L-B-A-D	Wake-up sequence .....	174
L-B-A-E	Prefix holdback .....	175

#### L-B-A-A Protocol type

`generic-rs-485-protocol-type`

The type of the serial output protocol. The following options are available:

ID	Option	Description
1	Sommer (default)	Sommer Bus Protocol (SBP); data values are returned with an index starting at 1. Multiple strings may be returned.
2	Standard	Standard protocol; data values are returned without an index in one string.

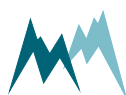

**L-B-A-B Measurement output**`generic-rs-485-protocol-measurement-output`

Specifies the timing of the serial data output.

ID	Option	Description
1	Just per command (default)	The output is only requested by commands via RS-232.
2	Measured values push	Acquired data are returned automatically after each measurement. Except for the <i>Function Sum</i> , no statistic is applied.
3	Storage values push	Stored data are returned automatically after they have been written to the data logger memory if one of the statistics selected in <i>Function</i> has been applied.

**L-B-A-C Information**`generic-rs-485-protocol-information`

The main measurement values are always included in the data output string. Additionally, the auxiliary values can be included.

ID	Option	Description
1	Main values	Only the main values are returned.
2	& Aux values	Main values and auxiliary values are returned.

**L-B-A-D Wake-up sequence**`generic-rs-485-protocol-wake-up-sequence`

Serial data can be transmitted to a recording device automatically without a request. However, many devices demand a wake-up sequence before they can receive and process data. The MRL-8P has the option to send a sync sequence and a prefix before data are transmitted (see [Waking-up a connected sensor](#)). The following options are available:

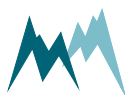

ID	Option	Description
1	Off	No wake-up sequence
2	Sync	The sync sequence UU~?~? is sent before the output string.
3	Prefix (default)	A blank with a time delay is sent before the output string.
4	Prefix & Sync	A blank with a time delay and the sync sequence UU~?~? is sent before the output string.

**L-B-A-E Prefix holdback**

`generic-rs-485-protocol-prefix-holdback`

The hold-back time defines the time delay between the prefix and the data string.

Value range	Default	Units
0...5'000	300	ms

**L-B-B Port**

L-B-B-A	Baud rate .....	175
L-B-B-B	Parity, stop bits .....	176
L-B-B-C	Minimum response time .....	176
L-B-B-D	Flow control .....	176

**L-B-B-A Baud rate**

`generic-rs-485-port-baud-rate`

The following transmission rates in bps (baud) can be selected:

ID	Option	Description
1	1'200	-
2	2'400	-
3	4'800	-
4	9'600 (default for sensors and data logger inputs)	-

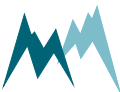

ID	Option	Description
5	19'200 (default if used with radio communication)	-
6	38'400	-
7	57'600	-
8	115'200 (default for data loggers)	-

### L-B-B-B Parity, stop bits

`generic-rs-485-port-parity-stop-bits`

The following combinations of parity and stop bits can be selected:

ID	Option	Description
1	No par, 1 stop (default)	No parity and 1 stop bit
2	No par, 2 stop	No parity and 2 stop bits
3	Even par, 1 stop	Even parity and 1 stop bit
4	Odd par, 1 stop	Odd parity and 1 stop bit

### L-B-B-C Minimum response time

`generic-rs-485-port-minimum-response-time`

This setting avoids failures of half-duplex interfaces. For this purpose the response to a command is delayed by the selected time. Additionally, the response is also kept temporally compact.

Value range	Default	Units
0...2'000	10	ms

### L-B-B-D Flow control

`mrl-com-port-flow-control`

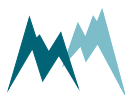

ID	Option	Description
1	Off	no flow control
2	XOFF-XON	XOFF-XON flow control, especially adapted for half-duplex systems
3	RTS-CTS (default)	RTS-CTS flow control
4	DFM-RC	Flowcontrol for Sommer Messtechnik DFM point-to-point radios.
5	DFM-TM	Flowcontrol for Sommer Messtechnik DFM tiny-mesh radios.

## L-C Inputs

L-C-A	RS-485	177
L-C-B	SDI-12 Master	186
L-C-C	Analog inputs	187
L-C-D	Additional meas. settings	191
L-C-E	RS485 Camera	193

### L-C-A RS-485

L-C-A-A	Sensor supply (always on)	178
L-C-A-B	SBP sensor feedback	178
	L-C-A-B-A Measurement output	178
	L-C-A-B-B Information	178
	L-C-A-B-C Wake-up sequence	179
	L-C-A-B-D Prefix holdback	179
L-C-A-C	Port	179
	L-C-A-C-A Baud rate	180
	L-C-A-C-B Parity, stop bits	180
	L-C-A-C-C Minimum response time	180
	L-C-A-C-D Transmitter warm-up time	181
	L-C-A-C-E Flow control	181
	L-C-A-C-F Sending window	181
	L-C-A-C-G Receiving window	181
	L-C-A-C-H Transparency to RS485 A/B	182
L-C-A-D	Trigger	182
	L-C-A-D-A Polling	182
	L-C-A-D-B Timeout	182
	L-C-A-D-C Sleep while timeout	183
	L-C-A-D-D Polling delay	183
L-C-A-E	Ext. Protocol (EXT)1	183
	L-C-A-E-A Function	183
	L-C-A-E-B Length	184
	L-C-A-E-C Separator	184
	L-C-A-E-D Start chars	184
	L-C-A-E-E Stop chars	184
	L-C-A-E-F Polling chars	184
	L-C-A-E-G Recv timeout	184
	L-C-A-E-H Binary	184

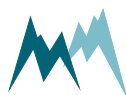

	L-C-A-E-I	Pos. separ. ....	185
	L-C-A-E-J	Test .....	185
L-C-A-F		Ext. Protocol (EXT)2 .....	185
L-C-A-G		Ext. Protocol (EXT)3 .....	185
L-C-A-H		Ext. Protocol (EXT)4 .....	185
L-C-A-I		Show hex data .....	186

### L-C-A-A Sensor supply (always on)

`mrl-12v-sensor-supply-always-on`

Sets the 12V sensor supply.

ID	Setting	Description
1	Off (default)	12V sensor supply is inactive
2	12 V	12V sensor supply is active

### L-C-A-B SBP sensor feedback

The parameters in this menu define the transmission of measurement data to serial RS-485 sensors operating with the Sommer Bus Protocol (SBP).

	L-C-A-B-A	Measurement output .....	178
	L-C-A-B-B	Information .....	178
	L-C-A-B-C	Wake-up sequence .....	179
	L-C-A-B-D	Prefix holdback .....	179

#### L-C-A-B-A Measurement output

`generic-rs-485-protocol-measurement-output`

Specifies the timing of the serial data output.

ID	Option	Description
1	Just per command (default)	The output is only requested by commands via RS-232.
2	Measured values push	Acquired data are returned automatically after each measurement. Except for the <b>Function Sum</b> , no statistic is applied.
3	Storage values push	Stored data are returned automatically after they have been written to the data logger memory if one of the statistics selected in <b>Function</b> has been applied.

#### L-C-A-B-B Information

`generic-rs-485-protocol-information`

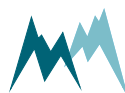

The main measurement values are always included in the data output string. Additionally, the auxiliary values can be included.

ID	Option	Description
1	Main values	Only the main values are returned.
2	& Aux values	Main values and auxiliary values are returned.

### L-C-A-B-C Wake-up sequence

`generic-rs-485-protocol-wake-up-sequence`

Serial data can be transmitted to a recording device automatically without a request. However, many devices demand a wake-up sequence before they can receive and process data. The MRL-8P has the option to send a sync sequence and a prefix before data are transmitted (see [Waking-up a connected sensor](#)). The following options are available:

ID	Option	Description
1	Off	No wake-up sequence
2	Sync	The sync sequence UU~?~? is sent before the output string.
3	Prefix (default)	A blank with a time delay is sent before the output string.
4	Prefix & Sync	A blank with a time delay and the sync sequence UU~?~? is sent before the output string.

### L-C-A-B-D Prefix holdback

`generic-rs-485-protocol-prefix-holdback`

The hold-back time defines the time delay between the prefix and the data string.

Value range	Default	Units
0...5'000	300	ms

### L-C-A-C Port

L-C-A-C-A Baud rate .....	180
L-C-A-C-B Parity, stop bits .....	180
L-C-A-C-C Minimum response time .....	180
L-C-A-C-D Transmitter warm-up time .....	181
L-C-A-C-E Flow control .....	181

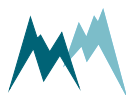

L-C-A-C-F Sending window .....	181
L-C-A-C-G Receiving window .....	181
L-C-A-C-H Transparency to RS485 A/B .....	182

### L-C-A-C-A Baud rate

`generic-rs-485-port-baud-rate`

The following transmission rates in bps (baud) can be selected:

ID	Option	Description
1	1'200	-
2	2'400	-
3	4'800	-
4	9'600 (default for sensors and data logger inputs)	-
5	19'200 (default if used with radio communication)	-
6	38'400	-
7	57'600	-
8	115'200 (default for data loggers)	-

### L-C-A-C-B Parity, stop bits

`generic-rs-485-port-parity-stop-bits`

The following combinations of parity and stop bits can be selected:

ID	Option	Description
1	No par, 1 stop (default)	No parity and 1 stop bit
2	No par, 2 stop	No parity and 2 stop bits
3	Even par, 1 stop	Even parity and 1 stop bit
4	Odd par, 1 stop	Odd parity and 1 stop bit

### L-C-A-C-C Minimum response time

`generic-rs-485-port-minimum-response-time`

This setting avoids failures of half-duplex interfaces. For this purpose the response to a command is delayed by the selected time. Additionally, the response is also kept temporally compact.



Value range	Default	Units
0...2'000	10	ms

#### L-C-A-C-D Transmitter warm-up time

`generic-rs-485-port-transmitter-warm-up-time`

The transmitter warm-up time defines the time before data is sent.

Value range	Default	Units
0...2'000	10	ms

#### L-C-A-C-E Flow control

`generic-rs-485-port-flow-control`

Flow control for the defined application.

ID	Option	Description
1	Off	no flow control
2	XOFF-XON blocking (default)	XOFF-XON flow control, especially adapted for half-duplex systems
4	DFM-RC	Flowcontrol for Sommer Messtechnik DFM point-to-point radios.
5	DFM-TM	Flowcontrol for Sommer Messtechnik DFM tiny-mesh radios.

#### L-C-A-C-F Sending window

`generic-rs-485-port-sending-window`

If XON-XOFF flow control is activated data are transmitted in blocks with the defined length.

Value range	Default	Units
200...5'000	300	ms

#### L-C-A-C-G Receiving window

`generic-rs-485-port-receiving-window`

If XON-XOFF flow control is activated transmission of blocks is delayed by the specified time.

Value range	Default	Units
200...5'000	300	ms



## L-C-A-C-H Transparency to RS485 A/B

generic-rs-485-port-transparency-rs-485-2

Only required in terminal mode. After activation, direct communication with a connected sensor is enabled, i.e. commands and their answers are exchanged over the RS485 A/B interface of the MRL-8P. With this mode the settings of a connected digital sensor can be read or changed.

The transparency mode has some restrictions:

- Data logger polling is inactive.
- You can only access a connected sensor with ??? if no other sensor is connected to the RS-485 bus.
- If another device in the RS-485 bus pushes data, it will interfere with any parametrization effort unless it is switched off.

## L-C-A-D Trigger

L-C-A-D-A Polling .....	182
L-C-A-D-B Timeout .....	182
L-C-A-D-C Sleep while timeout .....	183
L-C-A-D-D Polling delay .....	183

### L-C-A-D-A Polling

generic-rs-485-port-trig-polling

Sets the polling of connected digital sensors.

ID	Setting	Description
1	Off (default)	Regular polling is inactive.
2	On	Regular polling is active. This settings allows the interface to switch into sleep mode between pollings.

### L-C-A-D-B Timeout

generic-rs-485-port-trig-timeout

The time the MRL-8P is waiting until expected commands/answers are received via the RS485-2 interface.

Value range	Default	Units
3 ... 250	60	s

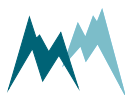

### L-C-A-D-C Sleep while timeout

generic-rs-485-port-trig-sleep-timeout

To reduce power consumption the MRL-8P can switch to a sleep mode between measurements.

ID	Setting	Description
1	Off (default)	MRL-8P remains activated between initialization of measurement and reception of measurement data, i.e. during <a href="#">Timeout</a>
2	On	MRL-8P is inactive, the connected sensor must send a Prefix command to wake up the MRL-8P for data transmission.

### L-C-A-D-D Polling delay

generic-rs-485-polling-delay

Time by which polling of multiple digital sensors is delayed. Used to poll sensors in sequence to avoid communication conflicts during subsequent measurement data transmission.

Value range	Default	Unit
0 ... 20	2	sec

### L-C-A-E Ext. Protocol (EXT)1

L-C-A-E-A Function .....	183
L-C-A-E-B Length .....	184
L-C-A-E-C Separator .....	184
L-C-A-E-D Start chars .....	184
L-C-A-E-E Stop chars .....	184
L-C-A-E-F Polling chars .....	184
L-C-A-E-G Recv timeout .....	184
L-C-A-E-H Binary .....	184
L-C-A-E-I Pos. separ. ....	185
L-C-A-E-J Test .....	185

### L-C-A-E-A Function

MRL-Ext-Protocol

The kind of evaluation for this protocol.

ID	Setting	Description
1	Off (default)	Not in use.
2	Position	Protocol has a fixed length and position for every value.
3	Separator	Protocol has a separator character that splits the string into values.

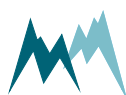

**L-C-A-E-B Length**

MRL-Ext-Protocol

Length of a incoming data string; means maximum length for separator protocols.

Value range	Default	Units
1 ... 255	26	-

**L-C-A-E-C Separator**

MRL-Ext-Protocol

Special hex field! Two-digit hex code of the character that is used as separator character. Length: 1 character. Only used for separator protocols.

**L-C-A-E-D Start chars**

MRL-Ext-Protocol

Special hex field! Two digit hex codes of the characters that signal a new line of data. Length: 12 characters.

**L-C-A-E-E Stop chars**

MRL-Ext-Protocol

Special hex field! Two digit hex codes of the characters that signal the end of a line of data. Length: 2 characters.

**L-C-A-E-F Polling chars**

MRL-Ext-Protocol

Special hex field! Two digit hex codes of the characters that need to be sent to trigger a new line of data. Length: 30 characters.

**L-C-A-E-G Recv timeout**

MRL-Ext-Protocol

Maximum time that is waited for a new line of data after polling command.

Value range	Default	Units
1 ... 240	5	sec

**L-C-A-E-H Binary**

MRL-Ext-Protocol

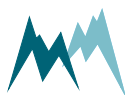

The measurement values received are in binary form and need to be converted.

ID	Setting	Description
1	Off (default)	No conversion needed
2	Bin	MSB first
3	Bin Sig	Signed
4	Bin MSB	MSB last
5	Bin Sig MSB	MSB last; signed
6	-	-

#### L-C-A-E-I Pos. separ.

MRL-Ext-Protocol

List of contained measurement values in ascending order. Only used for position protocols.

##### Start

MRL-Ext-Protocol

Position in line of data of the first character of the value.

##### Length

MRL-Ext-Protocol

Length of value at this position.

#### L-C-A-E-J Test

MRL-Ext-Protocol

Test the protocol configuration; send the polling command (if available), parse the received data into separate values and show the result.

#### L-C-A-F Ext. Protocol (EXT)2

See [Ext. Protocol \(EXT\)1](#).

#### L-C-A-G Ext. Protocol (EXT)3

See [Ext. Protocol \(EXT\)1](#).

#### L-C-A-H Ext. Protocol (EXT)4

See [Ext. Protocol \(EXT\)1](#).

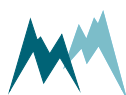

**L-C-A-I Show hex data**

Observes RS-485 interface and shows all incoming data in hexadecimal character code.

**L-C-B SDI-12 Master**

L-C-B-A	Max. measurement duration .....	186
L-C-B-B	Sensor supply (always on) .....	186
L-C-B-C	Sensor search .....	186
L-C-B-D	Change sensor address .....	186
L-C-B-E	Get sensor address .....	187
L-C-B-F	Transparency to SDI-12 .....	187

**L-C-B-A Max. measurement duration**

`generic-sdi-12-max-measurement-duration`

The timeout for commands sent to SDI-12 devices connected to the MRL-8P. After the MRL-8P has received a response, it goes back into sleep mode. If a SDI-12 device does not respond within this time the MRL-8P returns a measurement error.

Value range	Default	Units
0...255	20	sec

**L-C-B-B Sensor supply (always on)**

`mrl-12v-sensor-supply-always-on`

Sets the 12V sensor supply.

ID	Setting	Description
1	Off (default)	12V sensor supply is inactive
2	12 V	12V sensor supply is active

**L-C-B-C Sensor search**

`generic-sdi-12-sensor-search`

Searches for connected SDI-12 sensors and lists their identification and sensor address in the terminal window.

**L-C-B-D Change sensor address**

`generic-sdi-12-change-sensor-address`

Changes the SDI-12 address of a connected sensor.



**L-C-B-E    Get sensor address**

`generic-ask-sensor-address`

Reads the SDI-12 address and its identification of a single SDI-12 sensor connected to the MRL-8P.

**L-C-B-F    Transparency to SDI-12**

`mrl-sdi-12-transparency`

Enables direct communication with a connected device, i.e. commands and theirs answers are exchanged over the SDI-12 interface of the MRL-8P. Requires knowledge about SDI-12 communication.

**L-C-C    Analog inputs**

L-C-C-A	Warm-up time .....	187
L-C-C-B	ADC - conv. Rate .....	187
L-C-C-C	ADC filter .....	188
L-C-C-D	AN3 (N) type .....	188
L-C-C-E	AN4 (D) type .....	189
L-C-C-F	Sensor supply .....	189
	L-C-C-F-A    5V .....	189
	L-C-C-F-B    12V .....	189
	L-C-C-F-C    Extended supply (switched) .....	190
	L-C-C-F-D    Switch X21, Camera 1 .....	190

**L-C-C-A    Warm-up time**

`mrl-warm-up-time`

The time required to return valid measurements, e.g., if an analog sensor requires warm-up to perform properly.

Value range	Default	Units
-15 ... 250*	0	sec

\*negative values translate to 0.1 seconds, e.g. -5 is a warm-up time of 0.5 seconds.

**L-C-C-B    ADC - conv. Rate**

`mrl-adc-conversion-rate`

The sampling rate of the analog inputs.

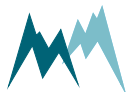

ID	Setting	Description
1	2 Hz	Sampling rate of 2 Hz
2	3 Hz	Sampling rate of 3 Hz
3	5 Hz	Sampling rate of 5 Hz
4	8 Hz	Sampling rate of 8 Hz
5	25 Hz	Sampling rate of 25 Hz
6	62 Hz (default)	Sampling rate of 62 Hz
7	125 Hz	Sampling rate of 125 Hz
8	250 Hz	Sampling rate of 250 Hz

### L-C-C-C ADC filter

`mrl-adc-filter`

Filter for analog data acquisition.

ID	Setting	Description
1	Off (default)	Each analog channel is sampled once and no filter is applied.
2	Minimum of 3	Each analog channel is sampled three times per measurement cycle and the minimum value is returned.
3	Median of 3	Each analog channel is sampled three times per measurement cycle and the median value is returned.
4	Mean of 3	Each analog channel is sampled three times per measurement cycle and the mean value is returned.

### L-C-C-D AN3 (N) type

`mrl-an3-type`

Measurement type of analog input channel AN3.

ID	Setting	Description
1	Voltage 2.5 (default)	Analog voltage input 0V ... 2.5V.
2	NTC	Measures the resistance of an NTC-thermistor.
3	R meas > 2k	Measures a resistance >2 kΩ.

## L-C-C-E AN4 (D) type

mrl-an4-type

Measurement type of analog input channel AN4.

ID	Setting	Description
1	Voltage 2.5(default)	Analog voltage input 0V ... 2.5V.
2	Voltage 0.3	Analog voltage input 0V ... 0.3V.
3	R meas > 1k2	Measures a resistance 0 ... 100 kΩ.
4	R meas < 1k2	Measures a resistance 0 ... 1.2 kΩ.
5	Pt1000	Measures the resistance of a Pt1000 temperature sensor.

## L-C-C-F Sensor supply

L-C-C-F-A 5V .....	189
L-C-C-F-B 12V .....	189
L-C-C-F-C Extended supply (switched) .....	190
L-C-C-F-D Switch X21, Camera 1 .....	190

### L-C-C-F-A 5V

mrl-5v-sensor-supply

Sets the 5V analog sensor supply.

ID	Setting	Description
1	Off (default)	5V sensor supply is inactive
2	Switched	5V sensor supply is active during analog measurements
3	Always on	5V sensor supply is always on

### L-C-C-F-B 12V

mrl-12v-sensor-supply

Sets the 12V sensor supply.

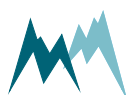

ID	Setting	Description
1	Off (default)	12V sensor supply is inactive
2	Switched	12V sensor supply is active during analog measurements
3	Always on	12V sensor supply is always on

#### L-C-C-F-C Extended supply (switched)

mrl-extended-supply

Auxiliary voltage and current output for analog measurements. If one of the options is selected, **Warm-up time** applies.

ID	Setting	Description
1	Off (default)	Extended supply is inactive
2	2.5V	2.5V are supplied at the <b>2.5V Ref-Out</b> pin
3	0.5mA	0.5mA are supplied at the <b>CurrH</b> pin
4	2.5V + 0.5mA	2.5V are supplied at the <b>2.5V Ref-Out</b> pin and 0.5mA at the <b>CurrH</b> pin

#### L-C-C-F-D Switch X21, Camera 1

mrl-switch-usage

Activates switched 12-V sensor supply (**X21**) for first camera.

ID	Setting	Description
1	Off (default)	Switched supply voltage is not used.
2	SW 01	SW 01 is active during measurements or image transfer.
3	SW 02	SW 02 is active during measurements or image transfer.
4	SW 03	SW 03 is active during measurements or image transfer.



**ATTENTION** Use the power supply of terminal **X20** if you need to supply a sensor or camera permanently!



**ATTENTION** If two cameras are used, their supply has to be switched by **X21** and they need to use separate switches!

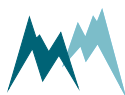

## L-C-D Additional meas. settings

L-C-D-A	Wind speed measurement duration .....	191
L-C-D-B	Storage interval asynchronous .....	191
L-C-D-C	Sum, reset time .....	192
L-C-D-D	X20 reset .....	192
L-C-D-E	Monthly event, day of month .....	192
L-C-D-F	Conversion table A .....	192
L-C-D-G	Conversion table B .....	193

### L-C-D-A Wind speed measurement duration

`mrl-wind-speed-measurement-duration`

The time for measuring the wind speed with a connected anemometer. With longer measurement times lower velocities can be accurately determined. However, longer measurement times also increase power consumption.

Value range	Default	Unit
500...2000	1000	ms

### L-C-D-B Storage interval asynchronous

`mrl-occasional-storage-interval`

Storage interval of variables which are only stored at the time when their value changes.

Variables with the following S-TYP and S-MEA settings are stored by default in the asynchronous storage interval:

S-TYP	S-MEA
COUNT	Counter 1 Counter 2a
SYS	Key A Key S Manual Excp. A Excp. B Mo excep. Mo srv Message



**NOTE** By adding the command `SY` in [Measurement table](#), the variable can be forced to be stored in the primary storage interval.

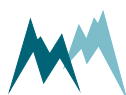

Value range	Default	Unit
00:00:00 ... 23:59:59	00:01:00	-

### L-C-D-C Sum, reset time

mrl-sum-reset-time

Time at which the sums of summed variables defined in [Measurement table](#) are reset to zero.

Value range	Default	Unit
00:00:00 ... 23:59:59	07:00:00	-

### L-C-D-D X20 reset

mrl-x20-reset

If activated, the input power supply of the X20 terminal is switched off and on again daily at [Sum, reset time](#). Generally used to reset connected sensors and other devices.

ID	Setting	Description
1	Off (default)	Reset is not active
2	10 sec	Power supply of X20 terminal is switched off for 10 seconds
3	30 sec	Power supply of X20 terminal is switched off for 30 seconds



**NOTE** Terminal X20 is also switched off if the battery voltage falls below [Internal low volt. disconnect](#).

### L-C-D-E Monthly event, day of month

mrl-monthly-event

Day of month at which summed variables are reset to zero.

Value range	Default	Unit
0... 31	1	-

### L-C-D-F Conversion table A

mrl-A-table

X-Y look-up table with up to 32 data-pairs, where X has to be in ascending order. For a variable in [Measurement table](#) with the function VA in S-ADD the measured variable is passed as X to the look-

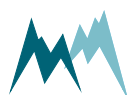

up table and the corresponding inter- and extrapolated value of **Y** is returned. Up to 6 decimal places are supported.

**L-C-D-G Conversion table B**

mrl-B-table

X-Y look-up table with up to 32 data-pairs, where **X** has to be in ascending order. For a variable in **Measurement table** with the function **VB** in **S-ADD** the measured variable is passed as **X** to the look-up table and the corresponding inter- and extrapolated value of **Y** is returned. Up to 6 decimal places are supported.

**L-C-E RS485 Camera**

L-C-E-A	Quantity .....	193
L-C-E-B	Switch X21, Camera 1 .....	193
L-C-E-C	Switch X21, Camera 2 .....	194
L-C-E-D	Warm-up time .....	194
L-C-E-E	Solar nightshutdown .....	194
L-C-E-F	View .....	195

**L-C-E-A Quantity**

mrl-quantity-camera

The number of serial cameras connected to the MRL-8P.

Value range	Default	Unit
None ... 2	None	-

**L-C-E-B Switch X21, Camera 1**

mrl-switch-usage

Activates switched 12-V sensor supply (**X21**) for first camera.

ID	Setting	Description
1	Off (default)	Switched supply voltage is not used.
2	SW 01	SW 01 is active during measurements or image transfer.
3	SW 02	SW 02 is active during measurements or image transfer.
4	SW 03	SW 03 is active during measurements or image transfer.

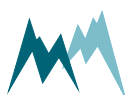



**ATTENTION** Use the power supply of terminal **X20** if you need to supply a sensor or camera permanently!



**ATTENTION** If two cameras are used, their supply has to be switched by **X21** and they need to use separate switches!

### L-C-E-C Switch X21, Camera 2

mrl-switch-usage

Activates switched 12-V sensor supply (**X21**) for second camera.

ID	Setting	Description
1	Off (default)	Switched supply voltage is not used.
2	SW 01	SW 01 is active during measurements or image transfer.
3	SW 02	SW 02 is active during measurements or image transfer.
4	SW 03	SW 03 is active during measurements or image transfer.



**ATTENTION** Use the power supply of terminal **X20** if you need to supply a sensor or camera permanently!



**ATTENTION** If two cameras are used, their supply has to be switched by **X21** and they need to use separate switches!

### L-C-E-D Warm-up time

mrl-warm-up-time-camera

The warm-up time of the camera. Time between the camera is powered up and the image has been triggered by the MRL-8P.

Value range	Default	Unit
0 ... 120	10	sec

### L-C-E-E Solar nightshutdown

mrl-solar-nightshutdown

Deactivation of the camera during the night. Only applicable if MRL-8P is solar powered.

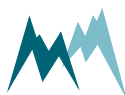

ID	Setting	Description
1	off	Camera takes pictures during night and day.
2	on (default)	Camera does not take picture during the night.

**L-C-E-F View**

mrl-view

Function to acquire a picture per activated camera. Activates the first camera and displays the recorded JPEG-image in an image viewer and if a second camera is present, activates the second camera and displays the recorded JPEG-image in an image viewer. The images are also stored in the default data location of the Commander(generally *C:\Users\Public\Documents\Sommer\Data\*). If triggered with a terminal editor, the acquired image is displayed in its binary code.

**L-D Additional settings**

L-D-A Sommer ID ..... 195  
 L-D-B Block size, data load ..... 195  
 L-D-C Internal low volt. disconnect ..... 196  
 L-D-D SommerXF starts with BOM ..... 196  
 L-D-E Display access ..... 197  
 L-D-F LCD, Contrast ..... 197  
 L-D-G LCD, Brightness ..... 197  
 L-D-H Transmission file size ..... 198  
 L-D-I Network timeout factor ..... 198

**L-D-A Sommer ID**

generic-sommer-id

The Sommer ID is used to define stations within the Commander software. The ID is preset in the device and corresponds to its serial number.SOMMER suggests to change the ID only, if a MRL-8P device is replaced. In such a case it can be practical to change the ID of the new device to the ID of the replaced device to guarantee data consistency. It is important that two devices that have the same combination of Sommer ID and Station ID, do NOT access the IP-Call server or MDS!

**L-D-B Block size, data load**

mrl-block-size-data-load

The maximum amount of data transferred with one communication block requested by a data acquisition software.

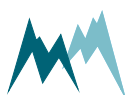

Value range	Default	Units
50...250	250	-

## L-D-C Internal low volt. disconnect

mrl-internal-low-volt-disconnect

To prevent deep discharge of the MRL-8P batteries, the device switches off if the battery voltage drops below the specified limit. It then checks every hour if the battery has recuperated again and eventually switches back to normal measurement mode. The limit depends on the battery and the duration the battery has to supply the station without any recharge; consult the battery datasheet for more information.

Value range	Default	Unit
0...11	0	V



**NOTE** If set to *0*, deep discharge is not monitored! This may be applied when using an external charger with an external battery (no battery is connected to terminal X1).



**ATTENTION** Inappropriate setting of the voltage limit can seriously impair the continuous operation of the MRL-8P or even lead to a complete failure of the station! Once the battery voltage drops to **Internal low volt. Disconnect**, all power outputs of the MRL-8P incl. X20 are switched off.

## L-D-D SommerXF starts with BOM

mrl-sommerxf-starts-with-bom

The BOM (Byte Order Mark) labels the downloaded data file to indicate that special characters within the file are coded.

ID	Setting	Description
1	On (default)	BOM is included in the data file.
2	Off	BOM is not included in the data file.

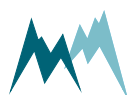

## L-D-E Display access

mrl-exposure-lock

Sets data visibility on the MRL-8P display.

ID	Setting	Description
1	Open(default)	Data download by USB and display of measurement data are accessible.
2	Code (USB)	Data download by USB requires an access code.
3	Code (data view + USB)	Data download by USB and display of measurement data require an access code.



**ATTENTION** As long as the display is active, the entered access code keeps all system settings of the logger unlocked!

## L-D-F LCD, Contrast

mrl-lcd-contrast

The contrast of the LCD-display.

ID	Setting	Description
1	weak	low contrast
2	base (default)	base contrast
3	medium	medium contrast
4	high	high contrast

## L-D-G LCD, Brightness

mrl-lcd-brightness

The MRL-8P is equipped with an integrated ambient light sensor that is used to automatically adjust the display brightness.

If the light intensity is below the specified value, the backlight brightness is automatically adjusted to a suitable level. If the value is exceeded, the display backlight is switched off.

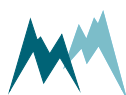

Value range	Default	Unit
0...3000	40	lm

## L-D-H Transmission file size

`mrl-transmission-file-size`

Maximum file size per data transfer.



**NOTE** If the MRL-8P acquires more data in a [Data transmission interval](#) than it can send, the excess data are sent with the next interval. A smaller file size may be selected to assure complete data transmission in case of bad wireless communication. However, this may also lead to jamming if not all data can be transmitted.

Value range	Default	Units
10'000... 500'000	101400	Byte

## L-D-I Network timeout factor

`mrl-network-timeout-factor`

Extends all data transmission timeouts required for mobile and Ethernet communication by this factor. Occasionally used for slow communication paths or slow data servers.

Value range	Default	Unit
1.0 ... 5.0	1	-

## M Region format

M-A	Language/Sprache .....	198
M-B	Decimal character .....	199
M-C	Timezone .....	199

### M-A Language/Sprache

`generic-language`

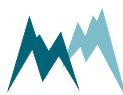

The menu language.

ID	Option	Description
1	German/Deutsch	German language
2	English/Englisch (default)	English language

## M-B Decimal character

`generic-decimals-character`

The character used as decimal separator in the values of the settings, in serial data strings and in .csv files.

ID	Option	Description
1	Comma	-
2	Dot (default)	-

## M-C Timezone

`mrl-time-zone`

The offset in seconds of the local time to UTC. For example, a local time of UTC+1 is entered as *3600* sec.

Value range	Default	Unit
-43'200 ... 43'200	3'600	sec

## N Special functions

N-A	Device status .....	200
N-B	Last date sync. ....	200
N-C	Last time sync. ....	200
N-D	View setup .....	200
N-E	Continuous meas. mode (temp). ....	200
N-F	Set factory default .....	200
N-G	Temp. load factory default .....	200
N-H	Relaunch program .....	201
N-I	Replace program .....	201

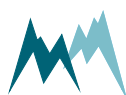

## N-A Device status

`generic-special-functions-device-status`

Displays information about the device (Serial number, [System advice codes](#), [Device clock](#), last queried [modem status \(Mo CSQ\)](#), etc.) and the software version. In this mode it is possible to reset [sum variables](#), [System advice codes](#) and the [internal data storage](#).

## N-B Last date sync.

`mrl-sync-date-last`

The date at which the MRL-8P has been last synchronized; read only.

## N-C Last time sync.

`mrl-sync-time-last`

The time at which the MRL-8P has been last synchronized; read only.

## N-D View setup

`generic-special-functions-view-setup`

All parameters of the MRL-8P are listed in the terminal window.

## N-E Continuous meas. mode (temp).

`generic-special-functions-continuous-meas-mode`

Inactive in the Commander menu. This feature can be triggered in the Commander under the [Measurement \(F3\)](#) tab with the command [Start polling measurements](#) and then [Start polling WITH measurements](#). When active, measurements are performed continuously, ignoring the specified measurement interval.

## N-F Set factory default

`generic-special-functions-set-factory-default`

All parameters are reset to factory defaults. Only available in terminal-mode.

## N-G Temp. load factory default

`generic-special-functions-temp-load-factory-default`

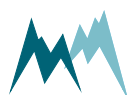

Loads factory default values temporarily. Only available in terminal mode.

## **N-H Relaunch program**

`generic-special-functions-relaunch-program`

The device is restarted. Powering the device off and on again is equivalent.

## **N-I Replace program**

`generic-special-functions-replace-program`

The device is set into a "Boot Loader" mode for three minutes to upload new software remotely in case supply off and on again is not applicable.



# Appendix A Troubleshooting

1.1	Configuration errors .....	202
1.1.1	Conflict messages .....	202
1.1.2	Parameter conflicts .....	203
1.1.3	Setup conflicts .....	205
A.2	Connections .....	207
A.2.1	Commander cannot connect to the MRL-8P via RS-232 port .....	207
A.2.2	Commander cannot connect to the MRL-8P by IP call .....	207
A.2.3	Commander cannot connect to the MRL-8P by socket connection .....	209
A.3	Devices .....	209
A.3.1	The MRL-8P is not responding or returns unreadable characters .....	209
A.3.2	Commander does not find connected RS-485 sensors .....	210
A.4	Measurement data .....	210
A.4.1	Measurement data are not updated .....	210
A.4.2	MRL-8P receives no data from RS-485 (SBP) sensors .....	211
A.5	RS-485 .....	211
A.5.1	Configuration via terminal shows unexpected behavior .....	211
A.6	SDI-12 .....	212
A.6.1	The MRL-8P is not detected by a SDI-12 master device .....	212
A.6.2	Data logger receives no SDI-12 data .....	212
A.7	Counter input .....	213
A.7.1	The counter input is not working .....	213
A.8	Camera .....	214
A.8.1	Camera does not record images .....	214
A.8.2	Transmitted images are incomplete .....	214
A.9	Data transmission .....	215
A.9.1	Data are not transmitted to server .....	215
A.10	Notifications .....	216
A.10.1	No message was sent upon limit violation .....	216
A.10.2	I receive repeated messages after limit violation .....	216
A.11	Firmware & software .....	217
A.11.1	Commander loads wrong setup .....	217
A.11.2	Firmware update via RS-232 is aborted .....	217
A.12	Time & date .....	217
A.12.1	Measurement values are one hour behind .....	217
A.12.2	Data logger clock displays year 2050 or 2099 .....	218

## 1.1 Configuration errors

### 1.1.1 Conflict messages

During configuration with the Commander software, the MRL-8P may return conflict messages after one or more parameters have been changed and uploaded to the device. An example is shown in [Figure 1](#).

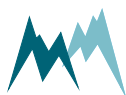

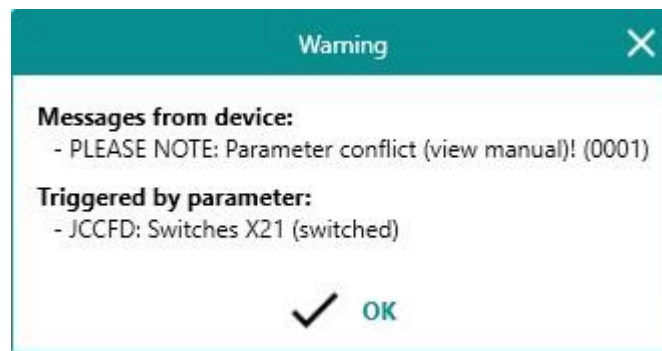

Figure 1 Example of a conflict message

The pop-up window lists the parameters and their indices which have triggered the warning. See [Parameter conflicts](#) for details.



**ATTENTION** If a conflict occurs, invalid settings are replaced automatically with valid values. Verify the values of the conflicting parameters and adapt them if needed!

### 1.1.2 Parameter conflicts

A parameter conflict message as listed below is returned if the value of a parameter conflicts with another parameter setting.

Changed parameter	Affected parameter	Comment
Switch X21, Camera 1 in multiple sub-menus	Switch X21, Camera 1 in multiple sub-menus	If one of the <b>Switches X21</b> is changed, and if this change conflicts with another <b>Switches X21</b> , the older setting is set to <i>off</i> .
Switch X21, Camera 1 in multiple sub-menus or Switches X21 in <b>Messages, table</b>	Switch X21, Camera 1 in multiple sub-menus or Switches X21 in <b>Mes-sages, table</b>	If one of the <b>Switches X21</b> in the <b>Technics</b> menu conflicts with <b>Switches X21</b> in the <b>Mes-sages</b> menu, the intended change is set to <i>off</i> .
<b>Message</b> in <b>Messages, table</b>	<b>Message</b> in <b>Messages, table</b>	If <b>Text</b> is selected, and the MRL-8P is a version without a modem, <b>Message</b> is switched to <i>off</i> .

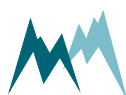

Changed parameter	Affected parameter	Comment
Identifier or Unit in Measurement table	-	A renamed variable or a change of unit may lead to a mismatch with previously recorded data. The error message <i>0002</i> is displayed.
Measurements, max. number or Aux measurements, max. number	Measurements, max. number or Aux measurements, max. number	The two numbers can only sum up to <i>99</i> . The most recently entered number is trimmed so that the total remains <i>99</i> .
Measurements, max. number or Aux measurements, max. number	All variables in Measurement table	If one or both of the two numbers are reduced, Function in Measurement table is set to <i>off</i> . The other settings of the deactivated variables are preserved.
<i>S-TYP COUNT</i> or <i>WIND</i> in Measurement table	<i>S-TYPCOUNT</i> or <i>WIND</i> in Measurement table	The Wind speed and Counter 2-b inputs are internally connected and can not be used simultaneously. <ul style="list-style-type: none"> <li>■ If a channel has been set to <i>WIND</i> with <i>Speed</i> and another channel is set to <i>COUNT</i> with <i>Counter 2ab</i>, <i>Counter 1</i> is set instead.</li> <li>■ If a channel has been set to <i>COUNT</i> with <i>Counter 2ab</i> and another channel is set to <i>WIND</i> with <i>Speed</i>, <i>Direct</i> is set instead.</li> </ul>
Flow control in menu COM	Number of measurement values	If Flow control is set to <i>DFM-RC</i> or <i>DFM-TM</i> , the number of measurement values per string is reduced to <i>6</i> .

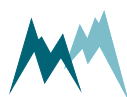

Changed parameter	Affected parameter	Comment
S-TYP SYS and S-MEA Mo-Srv in Measurement table	S-NUM	The MRL-8P provides 4 data transmission tasks. Any number larger than 4 written into S-NUM is altered to 1.
S-TYP SYS and S-MEA X21 in Measurement table	S-NUM	The MRL-8P provides 3 switches on terminal X21. Any number larger than 3 written into S-NUM is altered to 1.
S-TYP SYS and Message in Measurement table	S-NUM	The MRL-8P provides 16 message definitions. Any number larger than 16 written into S-NUM is altered to 1.

Table 1 Parameter conflict messages

### 1.1.3 Setup conflicts

A setup conflict message as listed below is returned if a modified setup with conflicting parameters is loaded onto the MRL-8P.

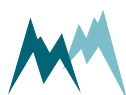

Conflict code	Parameter	Comment
0004	Sensor supply (always on) in input menus RS485 or SDI-12 Master and 12V in Analog inputs menu	A serial (RS485 or SDI-12) sensor requires permanent power supply. If Sensor supply (always on) is set to 12 V and 12V is set to <i>Off</i> or <i>Switched</i> , 12V is changed to <i>Always on</i> .
0002	Standby, start time and Standby, duration in menus Time window 1 and Time window 2	Time windows for remote connection cannot overlap. <ul style="list-style-type: none"> <li>■ If Time window 1 embraces Time window 2, Time window 2 is deactivated.</li> <li>■ If Time window 2 embraces Time window 1, Time window 1 adopts Time window 2 and Time window 2 is deactivated.</li> <li>■ If Time window 2 overlaps with Time window 1, Time window 2 is trimmed to start right after Time window 1.</li> <li>■ If Time window 2 starts before Time window 1 and overlaps with Time window 1, Time window 2 is trimmed so that it ends before Time window 1 starts.</li> </ul>

Table 2 Setup conflict messages

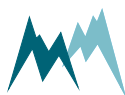

## A.2 Connections

### A.2.1 Commander cannot connect to the MRL-8P via RS-232 port

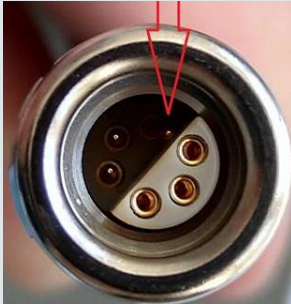
Reason	Solution
COM-port settings are incorrect	Run <a href="#">Communication assistant</a> to get the correct COM-port settings.
A pin of the RS-232 connector is damaged	Check if a pin of the plug or socket is damaged. If a pin is bent, straighten it with a small screw driver or tweezers. 
The MRL-8P and the laptop/PC have different grounds.	<ol style="list-style-type: none"> <li>1. If your USB-converter provides a ground-terminal, connect the ground of the MRL-8P to the converter.</li> <li>2. Unplug the power cord of your laptop.</li> </ol>

### A.2.2 Commander cannot connect to the MRL-8P by IP call

Reason	Solution
The MRL-8P is not powered.	Verify that the MRL-8P is powered. If applicable, check the connection of solar panel and battery.
The MRL-8P is solar powered and deep discharge protection is active.	Check the setting <a href="#">Internal low volt. disconnect</a> . The default is 11 V; this may be reduced to 9.5 V.
Modem inactive	<ol style="list-style-type: none"> <li>1. Activate modem in <a href="#">Operation</a></li> <li>2. Perform a modem test</li> </ol>

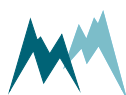

Reason	Solution
SIM card not present or not activated	Insert activated SIM card
Wrong SIM pin or pin not deactivated	Check <a href="#">SIM pin</a> , or deactivate SIM pin and enter -1 in <a href="#">SIM pin</a>
Prepaid SIM card has run out of credit	Recharge prepaid SIM card
Modem is not registered at the provider-side	In some countries, e.g. USA, Turkey, Azerbaijan ..., the mobile modem needs to be registered at the provider side. Check registration with your mobile provider.
The modem of the MRL-8P does not operate in the country of application. Especially USA and CA require dedicated modems.	Contact Sommer Messtechnik to check for the correct modem.
Incorrect APN	Check APN settings
Station settings are incorrect	Check <a href="#">Station settings</a> in the <a href="#">CommanderStations(F7)</a> tab; especially <a href="#">Station number</a> , <a href="#">Sommer ID</a> and <a href="#">IP-Call password/IMSI number</a>
Time window for logger access set inappropriately	Adjust <a href="#">Standby, start time</a> and <a href="#">Standby, duration</a>
The modem configuration <a href="#">Net type</a> is wrong.	If the MRL-8P is operated in North America, set <a href="#">Net type</a> to <a href="#">Auto (US+CA)</a> .
Firewall settings of local network restrict connection to MRL-8P.	Contact your IT support to allow Commander IP-Call access.
No internet connection to the web server	Verify that you can reach <a href="https://mds.sommer.at">mds.sommer.at</a> or your own mds-server from your computer.
No antenna connected	Connect antenna
Antenna connector damaged	Replace antenna connector
Lithium button cell battery has run out of power (this also results in a wrong MRL-8P time)	Replace lithium button cell battery as described in <a href="#">How to replace the internal lithium battery</a>

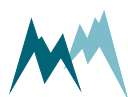

### A.2.3 Commander cannot connect to the MRL-8P by socket connection

Reason	Solution
Wrong modem/network setup.	See <a href="#">Commander cannot connect to the MRL-8P by IP call</a>
IP-address and/or port-number of the Commander and the MRL-8P do not match.	Make sure that IP-address and port match.
The <a href="#">Data transmission interval</a> is too short to allow access by Commander. If, for example, data transmission requires 60 s and <a href="#">Data transmission interval</a> is set to 60 s, a socket connection can not be established due to reinitialization of the connection.	Increase <a href="#">Data transmission interval</a> . Option: Consider using IP-Call if frequent access to the MRL-8P is required.

## A.3 Devices

### A.3.1 The MRL-8P is not responding or returns unreadable characters

Reason	Solution
The power supply is not connected or turned off.	Check if the power supply is connected and on.
The polarity of connected power supply wires is wrong.	Check the polarity of connected wires.
The power supply does not provide enough current.	Use a power supply that provides more current than listed in the <a href="#">Specifications</a> .
The power supply voltage is out of range.	Adjust the power supply to match the specified voltage range.
A pin of the connector plug is bent or broken.	Verify that all connector pins are straight.

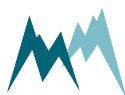

Reason	Solution
The COM-port has not been assigned correctly to the USB converter.	<ol style="list-style-type: none"> <li>1. Make sure to use a Sommer Messtechnik USB converter. Third party converters are not supported.</li> <li>2. Check the COM-port number using <a href="#">Windows Device Manager</a>.</li> <li>3. Plug in the USB converter first, then start Commander.</li> </ol>
The USB converter is faulty.	Replace the USB converter.
The USB port on your PC is not working.	Use another USB port.
The driver of the USB converter was incorrectly installed	Reinstall the driver of the USB converter.

### A.3.2 Commander does not find connected RS-485 sensors

Reason	Solution
<a href="#">Enable network scan</a> is off	Turn on <a href="#">Enable network scan</a>
Sensor not connected or not powered	Verify sensor connection and power supply
Wrong polarity of RS-485 wires	Verify that the yellow wire is connected to serial port A and the gray to serial port B.
Port settings do not match	Adapt port settings on sensor or in <a href="#">RS-485</a>
The MRL-8P and the connected sensor have different grounds.	Connect the grounds of the MRL-8P and the sensor.

## A.4 Measurement data

### A.4.1 Measurement data are not updated

The device is connected to the Commander, but the data are not updated.



Cause	Solution
The MRL-8P triggers measurements ( <a href="#">Polling</a> is <i>On</i> ) and triggers data (command <i>TD</i> added in <a href="#">S-ADD</a> in <a href="#">Measurement table</a> ) of a sensor.	If the MRL-8P triggers measurements, remove the <i>TD</i> command and set the sensor to push data after measurements. See also <a href="#">Trigger measurements of a Sommer Messtechnik RS-485 device</a> and <a href="#">Reading data from a Sommer Messtechnik RS-485 device</a> .

#### A.4.2 MRL-8P receives no data from RS-485 (SBP) sensors

Reason	Solution
Measurement trigger of sensor is set to <i>SDI-12/RS485</i> , but <a href="#">Polling</a> of MRL-8P is set to <i>off</i>	Turn on <a href="#">Polling</a>
MRL-8P shall receive pushed data, but connected sensor is set to polling mode	Set measurement trigger of connected sensor to <i>interval</i>
Data from a digital sensor are returned after <a href="#">Timeout</a> has elapsed.	Increase <a href="#">Timeout</a> to max. measurement duration of the connected sensor plus a few seconds, or reduce any excess warm-up time of the sensor.
Wrong sensor number or measurement number in <a href="#">Measurement table</a>	Verify sensor/measurement numbers in <a href="#">Measurement table</a>
MRL-8P and connected sensor have different grounds.	Connect the ground of the sensor to the ground of the MRL-8P.

### A.5 RS-485

#### A.5.1 Configuration via terminal shows unexpected behavior

Accessing the parameter menus in the terminal leads to unexpected behavior, e.g. after entering a menu character the terminal displays repeated error messages or jumps out of the parameter menu.

Reason	Solution
The sensor, power supply and PC/laptop do not share the same ground.	Verify that all equipment is connected to the same ground.

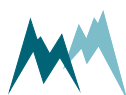

## A.6 SDI-12

### A.6.1 The MRL-8P is not detected by a SDI-12 master device

Reason	Solution
The MRL-8P and the SDI-12 master have different grounds.	Verify that the MRL-8P and the SDI-12 master are connected by a ground (GND) wire.

### A.6.2 Data logger receives no SDI-12 data

Reason	Solution
The <b>Measurement trigger</b> of a connected Sommer Messtechnik sensor is set to <i>Interval</i> .	Set the <b>Measurement trigger</b> of the sensor to <i>SDI-12/RS-485</i> .
The connected SDI-12 sensor measures continually in its own interval and does not need to be triggered. By default, the MRL-8P issues an <i>aM!</i> command to trigger a measurement. A continually measuring sensor requires an <i>aR!</i> command instead.	Enter the command <i>_R</i> in <i>S-ADD</i> in <b>each line</b> of the Measurement table that refers to the respective SDI-12 sensor.
Multiple sensors are connected to the data logger and two or more sensors have the same SDI-12 address.	If multiple sensors are connected to the same data logger, each sensor must be assigned a unique SDI-12 address.

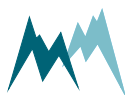

Reason	Solution
<p>The setting <b>Max. measurement duration</b> is too short.</p> <p>If the measurements of multiple SDI-12 sensors are triggered with the <b>M!</b> command, <b>Max. measurement duration</b> must be at least the sum of the measurement duration of these sensors. E.g., if sensor 1 has a measurement duration of 65 s and sensor 2 of 30 s, set <b>Max. measurement duration</b> to 100 s (95 s plus some margin).</p>	<p>Check the measurement duration of each sensor and set <b>Max. measurement duration</b> long enough.</p>
<p>Some third-party sensors may not issue a service request when they have completed a measurement.</p>	<p>If a sensor does not issue a service request after a measurement, a <b>C!</b> command instead of a <b>M!</b> command must be sent to start a measurement. Otherwise the data logger runs into a timeout or is waiting indefinitely for a service request.</p>
<p>The timing of the data logger between triggering a measurement and data request may be too tight.</p>	<p>Verify that the timing between triggering and data request is sufficient.</p> <p>Upon a measurement request, e.g. by an <b>M!</b> command, the sensor returns the required measurement duration.</p>

## A.7 Counter input

### A.7.1 The counter input is not working

Reason	Solution
<p>The DIP-switches on the electronic board of the MRL-8P are in the wrong position.</p>	<p>Check the position of the DIP-switches according to <b>DIP-switches</b>.</p>

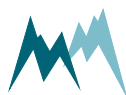

## A.8 Camera

### A.8.1 Camera does not record images

Reason	Solution
Camera not powered	Verify that camera is powered.
Warm-up time too short	Increase <a href="#">Warm-up time</a> by several seconds.
Wrong wiring of 12V power terminal X21	Reverse polarity of 12 V power supply wires.
Wrong polarity of RS-485 wires	Reverse polarity of RS-485 wires.
Other digital sensors interfere with data communication	Check configuration of connected RS-485 sensors; configure MRL-8P to poll data from sensors.
Image viewer on PC does not open	Verify that an image viewer is installed on your PC.
Third-party camera in use	Camera may require a different communication protocol. Contact Sommer Messtechnik for compatibility information.
Camera one is working but camera two has no images	12 V wiring of camera two does not match the setting of power terminal <a href="#">X21</a> .
There is a channel with <a href="#">S-ADD</a> PC entry that is prevent camera from being activated	Adapt the limit or fix the measurement so it does not violate the limit constantly.

### A.8.2 Transmitted images are incomplete

Reason	Solution
The time of the image transmission overlaps with the start of a sensor measurement, causing a communication conflict.	Change <a href="#">Data transmission offset</a> to a time that does not overlap with any other task. An odd time, e.g. <a href="#">00:02:20</a> , may resolve this conflict.

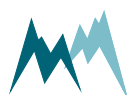

## A.9 Data transmission

### A.9.1 Data are not transmitted to server

Reason	Solution
No new data available for transmission	Check data storage interval
Data transmission interval set inappropriately	Adapt Data transmission interval
SIM card not present or not activated	Insert activated SIM card
Wrong SIM pin or pin not deactivated	Check SIM pin, or deactivate SIM pin and enter -1 in SIM pin
Prepaid SIM card has run out of credit	Recharge prepaid SIM card
Modem is not registered at the provider-side	In some countries, e.g. USA, Turkey, Azerbaijan ..., the mobile modem needs to be registered at the provider side. Check registration with your mobile provider.
Modem inactive	Activate modem in Operation
No antenna connected	Connect antenna
Antenna connector damaged	Replace antenna connector
Typo in APN configuration	Check APN address, APN user name and APN password
Typo in FTP or HTTP server configuration	Check FTP and HTTP settings (e.g., F instead of f, \ instead of /)
The mobile communication quality is bad and the data transmission tasks cannot be completed properly.	Set different Data transmission offset for each data transmission task, e.g. 00:00:37 and 00:01:21 for two tasks. This generates a restart of the modem.



**TIP** Also check [Commander cannot connect to the MRL-8P by IP call](#) for additional issues regarding mobile communication.

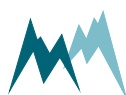

## A.10 Notifications

### A.10.1 No message was sent upon limit violation

Reason	Solution
Message trigger not active	Activate the required message in <a href="#">Messages of Measurement table</a>
Modem inactive	Activate modem in <a href="#">Operation</a>
SIM card not present or not activated	Insert activated SIM card
Wrong SIM pin or pin not deactivated	Check <a href="#">SIM pin</a> , or deactivate SIM pin and enter <a href="#">-1</a> in <a href="#">SIM pin</a>
Prepaid SIM card has run out of credit	Recharge prepaid SIM card
No antenna connected	Connect antenna
Antenna connector damaged	Replace antenna connector
Typo in recipients email address	Check Recipient in <a href="#">Messages, table</a>
SMTP server settings are incorrect	Check settings in <a href="#">E-mail/SMTP</a>
Mobile network provider only accepts SSL protocol	Add <a href="#">at{smtpcfg=1,587,1}</a> to <a href="#">Custom command 1</a> and change <a href="#">Port</a> to <a href="#">587</a>

### A.10.2 I receive repeated messages after limit violation

Reason	Solution
<a href="#">Min. Hold on message</a> ≤ <a href="#">Storage interval</a>	Increase <a href="#">Min. Hold on message</a>
<a href="#">Max. Hold on message</a> not deactivated	Deactivate <a href="#">Max. Hold on message</a> by entering 0

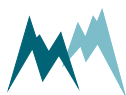

## A.11 Firmware & software

### A.11.1 Commander loads wrong setup

If the setup is reloaded from the device the Commander seems to display an old version.

Cause	Solution
The device has been connected to the same PC before and several different setup files have been loaded.	<ul style="list-style-type: none"> <li>In the <b>Communication</b> section of the Commander, select <b>Mode Connection</b> and click on the trash can icon on the right edge. Then, reload the setup from the device.</li> <li>Delete the setup files of the device that have been downloaded by Commander to the folder <code>C:\Users\Public\Documents\Sommer\Setup</code>. The respective files can be identified by the serial number in the file name and the file date.</li> </ul>

### A.11.2 Firmware update via RS-232 is aborted

Reason	Solution
USB to RS-232 converter cable is damaged or can only operate on 115200 baud.	Replace USB to RS-232 converter cable. The programmer requires 57600 baud.

## A.12 Time & date

### A.12.1 Measurement values are one hour behind

Reason	Solution
MRL-8P does NOT switch to daylight saving time, i.e. there is no time shift during clock change in spring and fall	Record data in default standard time, or adapt time manually

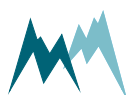

## A.12.2 Data logger clock displays year 2050 or 2099

Reason	Solution
Lithium button cell battery empty	Replace Lithium cell battery (see <a href="#">How to replace the internal lithium battery</a> )

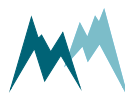

# Appendix B Tips & tricks

B.1	Set a minute counter .....	219
B.2	Set combined limits .....	220
B.3	Perform a delayed action .....	220
B.4	Set a status control .....	221
B.5	Activate a switched output .....	222
B.6	Send a weekly message .....	223
B.7	Monthly reset of summed variables .....	224
B.8	Send multiple SDI-12 requests .....	225

## B.1 Set a minute counter

### Use

Send a message or trigger an action in a defined interval

### Implementation

A minute counter is defined in [Measurement table](#) as follows:

1. Set the [Storage interval](#) to *00:01:00*
2. Create a channel with [Function sum](#)
3. Enter an arbitrary [Identifier](#) and the [Unit minutes](#)
4. Set [Decimals](#) to *none*, [Scale](#) to *0* and [Offset](#) to *1*

Main menu													
A	Station ID												
B	Station name												
C	Measurement interval	00:01:00											
D	Storage interval	00:01:00											
E	Measurements, max. number	1											
F	Aux measurements, max. number	0											
4	G	Measurements, table											
		Function	Identifier	Unit	Decimals	Scale	Offset		S-TYP	S-NUM	S-MEA	S-ADD	Limit
	01	sum	Timer	minutes	none	0	1	Adjustment	Test	SYS	0	+Bat V	
▷	H	Messages, table											
▷	I	Network											
▷	J	Technics											
▷	K	Special functions											

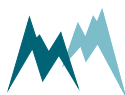

## B.2 Set combined limits

### Use

Combine limits that trigger an action. For example, a message should be sent if both, the snow depth and the air temperature exceed their individual limits.

### Implementation

Combined limits are defined in [Measurement table](#) as in the example below. The channels 5, 6 and 7 show how the limits are combined by logical AND, OR and NOR.

Main menu														
<b>A</b>	Station ID													
<b>B</b>	Station name													
<b>C</b>	Measurement interval		00:10:00											
<b>D</b>	Storage interval		00:10:00											
<b>E</b>	Measurements, max. number		7											
<b>F</b>	Aux measurements, max. number		0											
<b>G</b>	Measurements, table													
	Function	Identifier	Unit	Decimals	Scale	Offset		S-TYP	S-NUM	S-MEA	S-ADD	Limit	Messages	
<b>01</b>	actual	Snow depth	cm	as S		0.0	Adjustment	Test	SBP	1	2	150	<input type="checkbox"/> <input type="checkbox"/>	
<b>02</b>	actual	Temperature	°C	as S		0.0	Adjustment	Test	SBP	1	5	3	<input type="checkbox"/> <input type="checkbox"/>	
<b>03</b>	actual	Status snow	-	as S		0.0	Adjustment	Test	RECYC	1		GS	<input type="checkbox"/> <input type="checkbox"/>	
<b>04</b>	actual	Status T	-	as S		0.0	Adjustment	Test	RECYC	2		GS	<input type="checkbox"/> <input type="checkbox"/>	
<b>05</b>	actual	Snow AND T	-	as S		0.0	Adjustment	Test	RECYCM	3	4	D+	1.5	<input type="checkbox"/> <input type="checkbox"/>
<b>06</b>	actual	Snow OR T	-	as S		0.0	Adjustment	Test	RECYCM	3	4	D+	0.5	<input type="checkbox"/> <input type="checkbox"/>
<b>07</b>	actual	Snow NOR T	-	as S		0.0	Adjustment	Test	RECYCM	3	4	D+,ST	0.5	<input type="checkbox"/> <input type="checkbox"/>

## B.3 Perform a delayed action

### Use

Delay an action, e.g. a message, by a certain time.

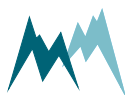

## Implementation

A delayed action is defined in [Measurement table](#) as follows:

1. Set the [Storage interval](#) to a time longer than [Measurement interval](#)
2. Create a channel with [Function](#) *minimum* or *maximum*
3. Set a [Limit](#) that triggers the action.
4. For *minimum* there must be *ST* in the *S-ADD* field, not for *minimum*.

The action is triggered after a full cycle of [Storage interval](#) has elapsed.

Main menu														
A	Station ID	<input type="text"/>												
B	Station name	<input type="text"/>												
C	Measurement interval	00:01:00												
D	Storage interval	00:10:00												
E	Measurements, max. number	1												
F	Aux measurements, max. number	0												
4	G	Measurements, table												
		Function	Identifier	Unit	Decimals	Scale	Offset		S-TYP	S-NUM	S-MEA	S-ADD	Limit	Messages
	01	Maximum	Snow depth	cm	As s		0.00	Adjustment	Test	SBP	1	2	ST	100
D	H	Messages, table												
D	I	Modem												
D	J	Technics												
D	K	Region format												
D	L	Special functions												

## B.4 Set a status control

### Use

Perform a regular action to verify that the system is running, e.g. send a status message every minute.

## Implementation

A status control is defined in [Measurement table](#) as follows:

1. Define a channel that reads a monitoring variable, e.g. the battery voltage, and set its limit value.
2. In [Messages, table](#) set [Min. Hold on message](#) to a duration smaller than [Storage interval](#).

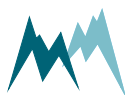

In the example below the status of the battery voltage is reported every 10 minutes. A corresponding message can be defined in [Messages, table](#)

Main menu															
A	Station ID														
B	Station name														
C	Measurement interval	00:01:00													
D	Storage interval	00:10:00													
E	Measurements, max. number	1													
F	Aux measurements, max. number	0													
▲	G	Measurements, table													
		Function	Identifier	Unit	Decimals	Scale	Offset		S-TYP	S-NUM	S-MEA	S-ADD	Limit	Messages	
	01	actual	Battery	V	as S		0.0	Adjustment	Test	SYS	1	+Bat V	ST	11.5	<input checked="" type="checkbox"/> 01 <input type="checkbox"/> 02
▾	H	Messages, table													
▾	I	Modem													
▲	J	Technics													
	A	Language/Sprache	english/englisch												
	B	Decimal character	dot												
▾	C	Additional settings													
▲	D	Additional timings													
	A	Sum, reset time	13:40:00												
	B	Occasional storage interval	00:01:00												
	C	Sync date (last)													
	D	Sync time (last)													
	E	min. Hold On message	1									min			
	F	max. Hold On message	0									min			
	G	Hold Commander	8									sec			
	H	Main Switch Reset	off												
	I	logger reboot time													

## B.5 Activate a switched output

### Use

Repeatedly trigger one of the MRL-8P switched outputs (SW1, SW2, SW3). In the example below a switched output is set to high after every 10 m<sup>3</sup> of water that have passed a discharge sensor. The output is active for 1 second.

### Implementation

A switched output is defined in [Measurement table](#) as follows:

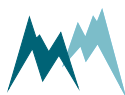

1. Add an auxiliary measurement channel in **Aux measurements, max. number**. This channel is displayed with index 99 at the end of the measurement table.
2. Complete the settings according to data line 99 the example below:
  1. The Scale of **0.03** converts the flow rate in l/s to a total flow in m<sup>3</sup> by multiplying the flow rate with the **Measurement interval**.
  2. **S-MEA 4** reads the **Discharge** in l/s as in data line 04.
  3. The command **TR** in **S-ADD** resets **Delta Discharge** after the **Limit** of **10** has been exceeded.
3. Add a switch-action in **Messages, table** by selecting **Message Switch**, activating one of the switches and setting an appropriate **Hold** time in seconds.

Main menu													
<b>A</b>	Station ID												
<b>B</b>	Station name												
<b>C</b>	Measurement interval	00:00:30											
<b>D</b>	Storage interval	00:00:30											
<b>E</b>	Measurements, max. number	6											
<b>F</b>	Aux measurements, max. number	1											
<b>G</b>	Measurements, table												
	Function	Identifier	Unit	Decimals	Scale	Offset		S-TYP	S-NUM	S-MEA	S-ADD	Limit	Messages
01	actual	Water level	mm	as S		0,00	Adjustment	Test	SBP	1	1		<input type="checkbox"/>
02	actual	Speed	m/s	as S		0,0	Adjustment	Test	SBP	1	2		<input type="checkbox"/>
03	actual	Quality (SNR)		as S		0,0	Adjustment	Test	SBP	1	3		<input type="checkbox"/>
04	actual	Discharge	l/s	as S		0	Adjustment	Test	SBP	1	4		<input type="checkbox"/>
05	sum	Daily Discharge	m <sup>3</sup>	as S		0,0	Adjustment	Test	COUNT		Counter 1		<input type="checkbox"/>
06	actual	Total Discharge	m <sup>3</sup>	as S		0,0	Adjustment	Test	SBP	1	5		<input type="checkbox"/>
99	sum	Delta Discharge	m <sup>3</sup>	2	0.03	0	Adjustment	Test	SBP	1	4	TR	10 <input checked="" type="checkbox"/>
<b>H</b>	Messages, table												
	message	Recipient	Subject	Content	Switch	Hold							
					<input type="checkbox"/> <input type="checkbox"/> <input type="checkbox"/>	sec							
01	Switch				<input checked="" type="checkbox"/> <input type="checkbox"/> <input type="checkbox"/>	1							

## B.6 Send a weekly message

### Use

Send a message with one or measurement data to a recipient in a certain interval, e.g. weekly, for documentation or information.

### Implementation

A weekly message is defined in **Measurement table** as follows:

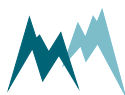

1. Add two auxiliary measurement channels in **Aux measurements, max. number**. These channels are displayed with indices 98 and 99 at the end of the measurement table.
2. Add the settings of channels 98 and 99 as shown below.
  - Channel 98 generates the number 1 after each measurement interval.
  - Channel 99 converts the measurement interval into minutes, adds the minutes and triggers a message every week (corresponds to 10'080 minutes).
3. Add a message as shown in the example below.
  - The message *%date% %time%: Discharge of %sname% is %cp04% l/s* sends the discharge value with the time stamp, e.g. *2022-03-21 07:00:00: Discharge of Channel Station 3 is 85 l/s*.

E	Measurements, max. number	1											
F	Aux measurements, max. number	2											
G Measurements, table													
	Function	Identifier	Unit	Decimals	Scale	Offset		S-TYP	S-NUM	S-MEA	S-ADD	Limit	Messages
01	Actual	Discharge	l/s	None	1	0	Adjustment	Test	SBP	1	4		<input type="checkbox"/>
98	Actual	Increment		None	0	1	Adjustment	Test	SYS	0	+Bat V		<input type="checkbox"/>
99	Sum	Dummy		None	1	0	Adjustment	Test	RECYC	98		PM NR TR 10080	<input type="checkbox"/>
H Messages, table													
A	Min. Hold On message	5		Min									
B	Max. Hold On message	0		Min									
C E-mail/SMTTP													
D Messages, table													
Message	Recipient	Subject	Content	Switches X21	Hold								
01	Text	06671234567	%date% %time%: Discharge of %sname% is %cp04% l/s.	5 0 8	sec								

 **TIP** For more information on S-ADD codes see [Measurement table](#).

## B.7 Monthly reset of summed variables

### Use

In many applications, e.g. water discharge measurements, it is common to report monthly totals. In the example below the water discharge measured by an SQ-R is reset to zero at the beginning of every month.



# Implementation

A monthly reset is defined in **Measurement table** as follows:

1. Add a channel that sums up your measured quantity.
2. In **S-ADD** enter the command *MR<sub>x</sub>*, where *x* is the day of the month. For example, *MR1* resets the sum on the 1st of every month. The reset time is set in **Sum, reset time**.

Main menu													
<b>A</b>	Station ID												
<b>B</b>	Station name												
<b>C</b>	Measurement interval	00:00:30											
<b>D</b>	Storage interval	00:00:30											
<b>E</b>	Measurements, max. number	6											
<b>F</b>	Aux measurements, max. number	0											
<b>G</b>	Measurements, table												
	Function	Identifier	Unit	Decimals	Scale	Offset		S-TYP	S-NUM	S-MEA	S-ADD	Limit	Messages
<b>01</b>	actual	Water level	mm	as S		0	Adjustment	Test	SBP	1	1		
<b>02</b>	actual	Speed	m/s	as S		0	Adjustment	Test	SBP	1	2		
<b>03</b>	actual	Quality (SNR)		as S		0	Adjustment	Test	SBP	1	3		
<b>04</b>	actual	Discharge rate	l/s	as S		0	Adjustment	Test	SBP	1	4		
<b>05</b>	sum	Monthly discharge	m <sup>3</sup>	as S		0	Adjustment	Test	COUNT		Counter 1	MR1	
<b>06</b>	actual	Total discharge	m <sup>3</sup>	as S		0	Adjustment	Test	SBP	1	5		
<b>H</b>	Messages, table												
<b>I</b>	Modem												
<b>J</b>	Technics												
<b>K</b>	Special functions												

## B.8 Send multiple SDI-12 requests

### Use

Some serial sensors provide a long list of measurement data that need to be requested by multiple SDI-12 commands, i.e., *M1!*, *M2!*, *M3!*,...

### Implementation

Multiple SDI-12 requests are implemented by adding *\_M1*, *\_M2*, *\_M3*, etc. to the **S-ADD** field of the measurement table. The corresponding **D!** commands are sent automatically. by the MRL-8P.

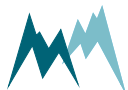



**NOTE** The *MO!* command is run by default and does not need to be added. Hence, for empty *S-ADD* fields *\_M0* is assumed.

The same principle can be applied to the *R!* and *C!* commands.

F Measurements, table													
	Function	Identifier	Unit	Decimals	Scale	Offset			S-TYP	S-NUM	S-MEA	S-ADD	
01	actual	Air Temperature	°C	as S		0	Adjustment	Test	SDI2	0	1	_M1	
02	actual	Rel. Humidity	%	as S		0	Adjustment	Test	SDI2	0	2	_M1	
03	actual	Dewpoint	°C	as S		0	Adjustment	Test	SDI2	0	3	_M1	
04	actual	Pressure	hPa	as S		0	Adjustment	Test	SDI2	0	4	_M1	
05	actual	Rel. Wind Speed	m/s	as S		0	Adjustment	Test	SDI2	0	2		
06	actual	Rel. Wind Dir.	°	as S		0	Adjustment	Test	SDI2	0	1		
07	actual	Corr. Wind Dir.	°	as S		0	Adjustment	Test	SDI2	0	3		
08	actual	Avg. Wind Speed	m/s	as S		0	Adjustment	Test	SDI2	0	2	_M9	
09	actual	Avg. Wind Dir.	°	as S		0	Adjustment	Test	SDI2	0	1	_M9	
10	actual	Wind Gust Speed	m/s	as S		0	Adjustment	Test	SDI2	0	4	_M9	
11	actual	Wind Gust Dir.	°	as S		0	Adjustment	Test	SDI2	0	3	_M9	
12	actual	Status Sensor	-	as S		0	Adjustment	Test	SDI2	0	5	_M1	
13	actual	Supply V	V	2	1	0	Adjustment	Test	SYS		+Sup V		
14	actual	Sun Azimuth	°	as S		0	Adjustment	Test	SDI2	0	4	_M7	
15	actual	Sun Elevation	°	as S		0	Adjustment	Test	SDI2	0	5	_M7	
16	actual	Sunrise	h:m	as S		0	Adjustment	Test	SDI2	0	1	_M7	
17	actual	Solar Noon	h:m	as S		0	Adjustment	Test	SDI2	0	2	_M7	
18	actual	Sunset	h:m	as S		0	Adjustment	Test	SDI2	0	3	_M7	
19	actual	Twilight Civil	h:m	as S		0	Adjustment	Test	SDI2	0	6	_M7	
20	actual	X Tilt	°	as S		0	Adjustment	Test	SDI2	0	3	_M4	
21	actual	Y Tilt	°	as S		0	Adjustment	Test	SDI2	0	4	_M4	



## Appendix C    Escape characters

The following escape characters may be used for parameter values where indicated:

Escape character	ASCII representation
\1	#
\2	;
\3	?
\4	
\r	<CR>
\n	<LF>
\t	<TAB>
\\	\

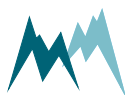

# Appendix D DIP-switches

The signal type of the counter inputs can be configured with three DIP-switches. Their location is shown in [Figure 2](#) and [Figure 3](#).

To configure the counter inputs to receive signals from a sensor with either an open collector output or a source output, set the DIP-switches according to the following table:

## New MRL-8P versions (3x4 switches)

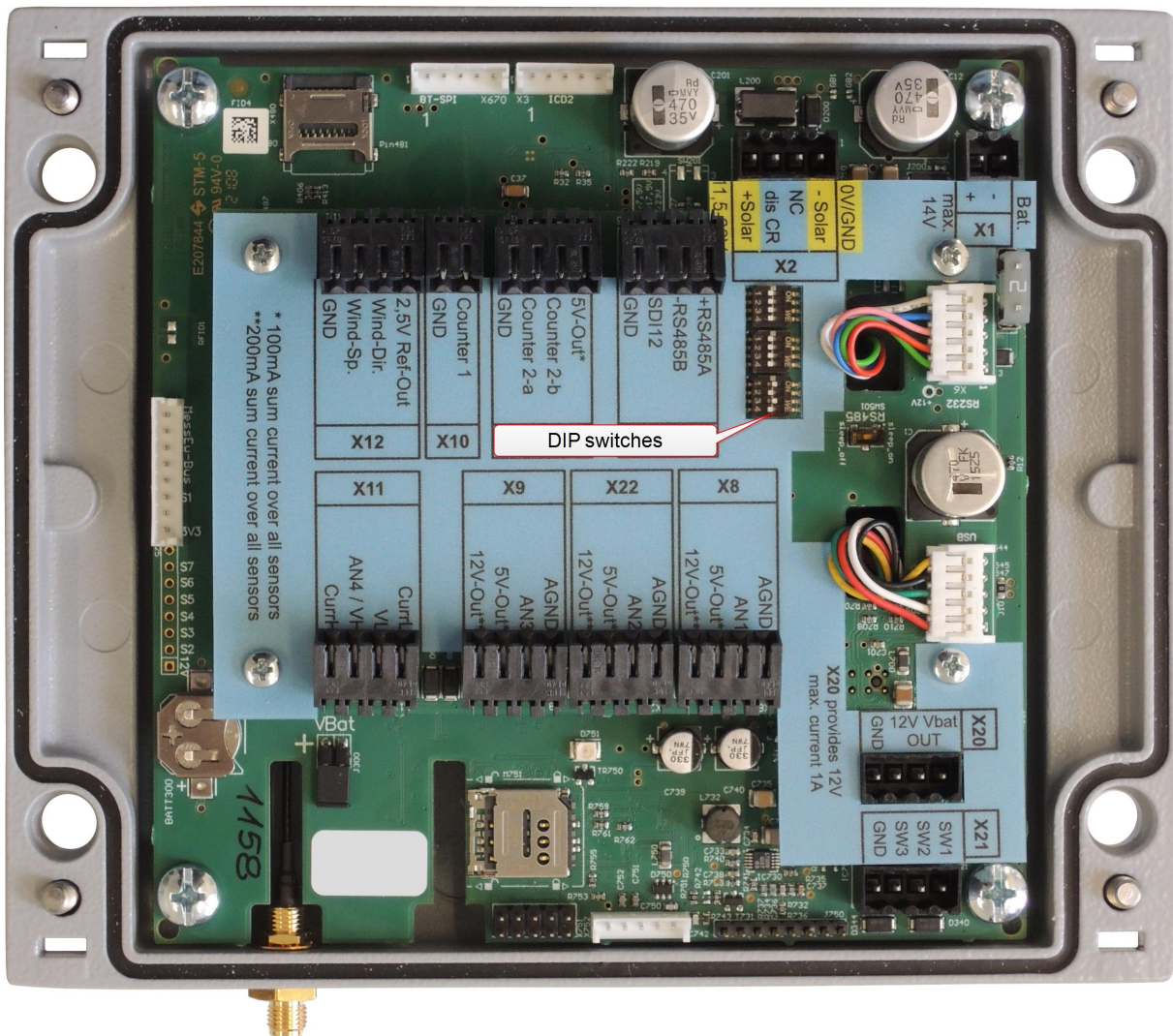
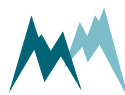
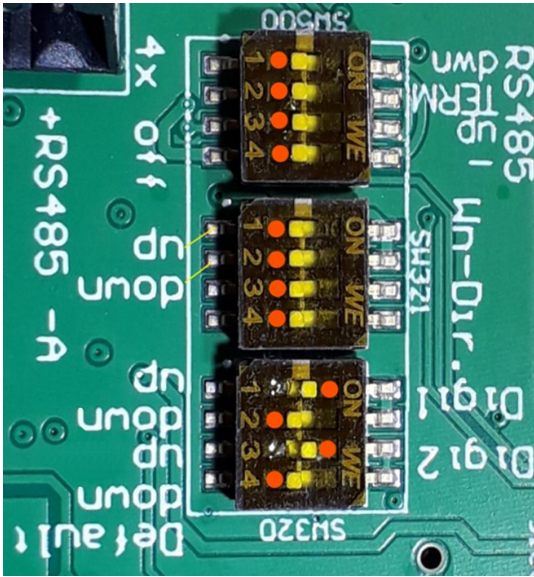

Figure 2 DIP-switches





Orange dots show the default positions.

DIP-switch	Position	Function
RS-485 (SW500)	SW1 On SW2 On SW3 On SW4 On	B with 3.0 kΩ to GND A with 150 Ω to B A with 1.1 kΩ to High B with 2.7 kΩ to GND
RS-485 sleep (SW501)	Off On	High ≅ 5 V High ≅ 3 V
Wn-Dir (SW321)	SW1 On SW2 On SW3 SW4	Wn-Dir: pull-up Wn-Dir: pull-down not used not used
Digi (SW320)	SW1 On SW2 On SW3 On SW4 On	Digi 1: pull-up Digi 1: pull-down Digi 2: pull-up Digi 2: pull-down

**Input-Areas of digital channels**

- pull-down: 0 ... 0,6 V
- pull-up: 2 ... 28 V

**Usage of Wn-Dir**

- Wind-direction: *SW1* and *SW2* to *Off*
- Counter 2-b: *SW1* to *On*, *SW2* to *Off*
- Trigger: *SW1* to *Off*, *SW2* to *On*

**Usage of Digi**

- Counter 1 & 2-a: *SW1* to *On*, *SW2* to *Off*, *SW3* to *On*, *SW4* to *Off*
- Trigger 1 & 2: *SW1* to *Off*, *SW2* to *On*, *SW3* to *Off*, *SW4* to *On*



Old MRL-8P versions (3x2 switches)

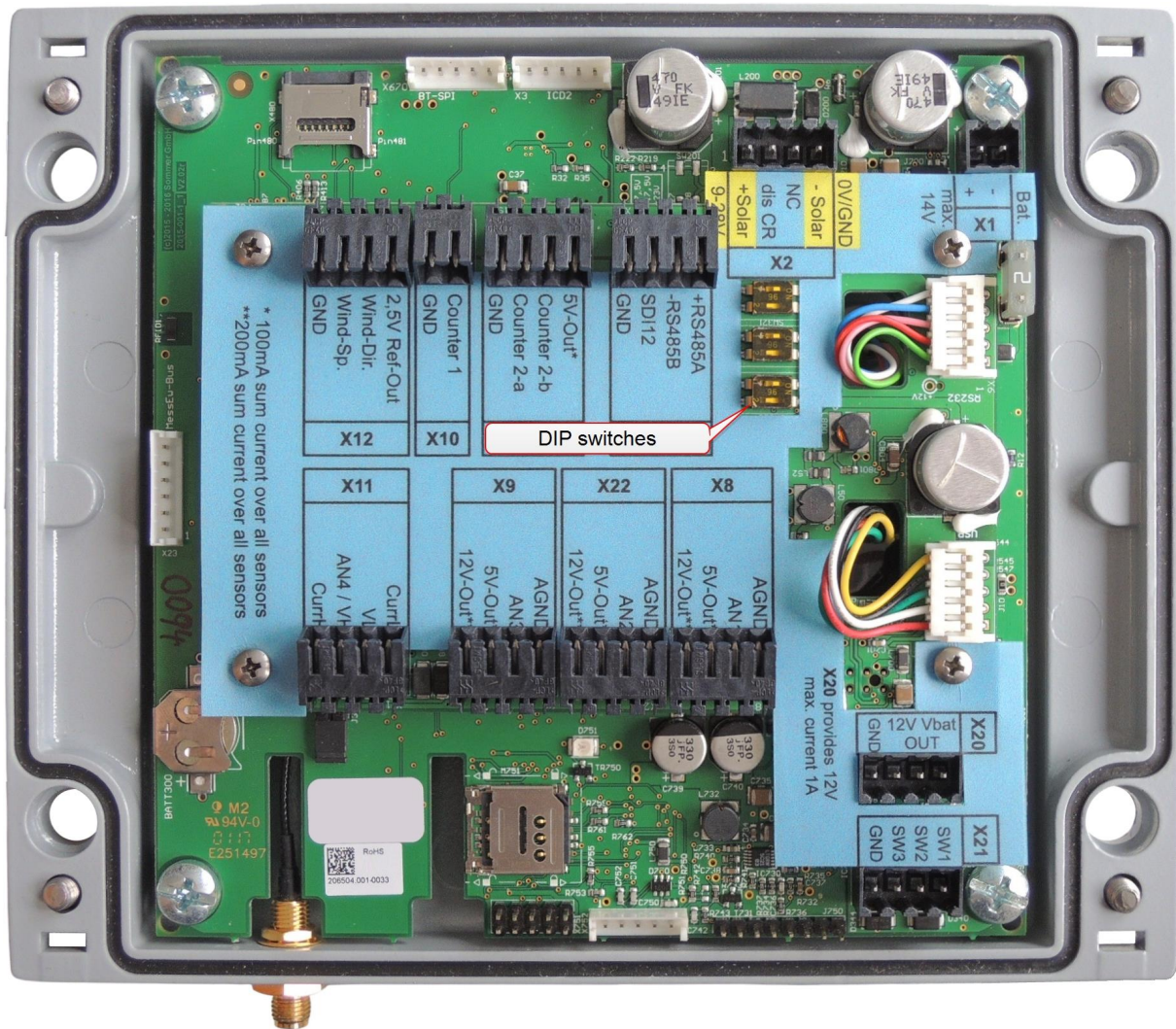
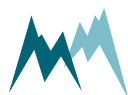







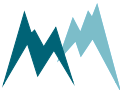

Figure 3 DIP-switches



DIP-switch	Position	Function
SW322	 (Default)	Pin <b>Wind-Dir</b> on terminal <b>X12</b> is configured as analog input to receive a wind direction signal (potentiometer), and pin <b>Counter-2b</b> on terminal <b>X19</b> is deactivated.
	 (Default)	Pin <b>Counter-2b</b> on terminal <b>X19</b> is configured as counter input with a pull-up resistor (connects to a sensor with an open-collector output). Pin <b>Wind-Dir</b> on terminal <b>X12</b> is deactivated.
	 (Default)	Pin <b>Counter-2b</b> on terminal <b>X19</b> is configured as counter input with a pull-down resistor (connects to a sensor with an active output).
SW321	 (Default)	Pin <b>Counter-2a</b> on terminal <b>X19</b> is configured as counter input with a pull-up resistor (connects to a sensor with an open-collector output).
	 (Default)	Pin <b>Counter-2a</b> on terminal <b>X19</b> is configured as counter input with a pull-down resistor (connects to a sensor with an active output).
SW320	 (Default)	Pin <b>Counter-1</b> on terminal <b>X10</b> is configured as counter input with a pull-up resistor (connects to a sensor with an open-collector output).
	 (Default)	Pin <b>Counter-1</b> on terminal <b>X10</b> is configured as counter input with a pull-down resistor (connects to a sensor with an active output).



## Appendix E System advice codes

In the [Device status](#), the device shows a group of four codes called System advice codes, each representing recent errors/problems occurred in different parts of the firmware.

The first code shows errors in the operating system (including supply).

The second code shows errors from hardware extensions.

The third code shows errors that result in measurement problems or data loss.

The fourth code shows minor errors that probably originate in faulty configuration.

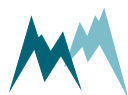

## Appendix F CRC-16 array

### CRC-16 array

```
1  crc16tab[] =
2  {
3  0x0000, 0x1021, 0x2042, 0x3063, 0x4084, 0x50A5, 0x60C6, 0x70E7,
4  0x8108, 0x9129, 0xA14A, 0xB16B, 0xC18C, 0xD1AD, 0xE1CE, 0xF1EF,
5  0x1231, 0x0210, 0x3273, 0x2252, 0x52B5, 0x4294, 0x72F7, 0x62D6,
6  0x9339, 0x8318, 0xB37B, 0xA35A, 0xD3BD, 0xC39C, 0xF3FF, 0xE3DE,
7  0x2462, 0x3443, 0x0420, 0x1401, 0x64E6, 0x74C7, 0x44A4, 0x5485,
8  0xA56A, 0xB54B, 0x8528, 0x9509, 0xE5EE, 0xF5CF, 0xC5AC, 0xD58D,
9  0x3653, 0x2672, 0x1611, 0x0630, 0x76D7, 0x66F6, 0x5695, 0x46B4,
10 0xB75B, 0xA77A, 0x9719, 0x8738, 0xF7DF, 0xE7FE, 0xD79D, 0xC7BC,
11 0x48C4, 0x58E5, 0x6886, 0x78A7, 0x0840, 0x1861, 0x2802, 0x3823,
12 0xC9CC, 0xD9ED, 0xE98E, 0xF9AF, 0x8948, 0x9969, 0xA90A, 0xB92B,
13 0x5AF5, 0x4AD4, 0x7AB7, 0x6A96, 0x1A71, 0x0A50, 0x3A33, 0x2A12,
14 0xDBFD, 0xCBDC, 0xFBBF, 0xEB9E, 0x9B79, 0x8B58, 0xBB3B, 0xAB1A,
15 0x6CA6, 0x7C87, 0x4CE4, 0x5CC5, 0x2C22, 0x3C03, 0x0C60, 0x1C41,
16 0xEDAE, 0xFD8F, 0xCDEC, 0xDDCD, 0xAD2A, 0xBD0B, 0x8D68, 0x9D49,
17 0x7E97, 0x6EB6, 0x5ED5, 0x4EF4, 0x3E13, 0x2E32, 0x1E51, 0x0E70,
18 0xFF9F, 0xEFBE, 0xDFDD, 0xCFFC, 0xBF1B, 0xAF3A, 0x9F59, 0x8F78,
19 0x9188, 0x81A9, 0xB1CA, 0xA1EB, 0xD10C, 0xC12D, 0xF14E, 0xE16F,
20 0x1080, 0x00A1, 0x30C2, 0x20E3, 0x5004, 0x4025, 0x7046, 0x6067,
21 0x83B9, 0x9398, 0xA3FB, 0xB3DA, 0xC33D, 0xD31C, 0xE37F, 0xF35E,
22 0x02B1, 0x1290, 0x22F3, 0x32D2, 0x4235, 0x5214, 0x6277, 0x7256,
23 0xB5EA, 0xA5CB, 0x95A8, 0x8589, 0xF56E, 0xE54F, 0xD52C, 0xC50D,
24 0x34E2, 0x24C3, 0x14A0, 0x0481, 0x7466, 0x6447, 0x5424, 0x4405,
25 0xA7DB, 0xB7FA, 0x8799, 0x97B8, 0xE75F, 0xF77E, 0xC71D, 0xD73C,
26 0x26D3, 0x36F2, 0x0691, 0x16B0, 0x6657, 0x7676, 0x4615, 0x5634,
27 0xD94C, 0xC96D, 0xF90E, 0xE92F, 0x99C8, 0x89E9, 0xB98A, 0xA9AB,
28 0x5844, 0x4865, 0x7806, 0x6827, 0x18C0, 0x08E1, 0x3882, 0x28A3,
29 0xCB7D, 0xDB5C, 0xEB3F, 0xFB1E, 0x8BF9, 0x9BD8, 0xABBB, 0xBB9A,
30 0x4A75, 0x5A54, 0x6A37, 0x7A16, 0x0AF1, 0x1AD0, 0x2AB3, 0x3A92,
31 0xFD2E, 0xED0F, 0xDD6C, 0xCD4D, 0xBDAA, 0xAD8B, 0x9DE8, 0x8DC9,
32 0x7C26, 0x6C07, 0x5C64, 0x4C45, 0x3CA2, 0x2C83, 0x1CE0, 0x0CC1,
33 0xEF1F, 0xFF3E, 0xCF5D, 0xDF7C, 0xAF9B, 0xBFBA, 0x8FD9, 0x9FF8,
34 0x6E17, 0x7E36, 0x4E55, 0x5E74, 0x2E93, 0x3EB2, 0x0ED1, 0x1EF0
35 }
```

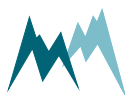

# Glossary

## A

### **ablation**

removal of material from the surface of an object by vaporization, chipping, or other erosive processes. In this case the opposite of snow accumulation.

## B

### **blowing snow**

an ensemble of snow particles raised by the wind to moderate or great heights above the ground; the horizontal visibility at eye level is generally very poor NOTE See also drifting snow

## D

### **drifting snow**

snow raised from the snow surface by the wind to a height of less than 2 metres; it does not restrict horizontal visibility at 2 metres or more above the surface NOTE See also blowing snow

## F

### **firn**

well-bonded and compacted snow that has survived the summer season, but has not been transformed to glacier ice NOTE Typical densities

are 400 - 830 kg·m<sup>-3</sup>. Thus, firn is the intermediate stage between snow and glacial ice where the pore space is at least partially interconnected. Firn usually results from both melt-freeze cycles and compaction by overload, or from compaction alone, as in inland Antarctic snow.

### **fractional snow cover**

the areal extent of snow-covered ground in relation to the total catchment, usually expressed as % of total area in a given region

## G

### **gliding snow**

slow, gliding motion of the snowpack over smooth or wet ground, e.g. grassy slopes or smooth rock slabs, attaining velocities of a few millimetres to a few metres per day

## I

### **IP-Call**

A technology that provides communication services over the Internet.

## M

### **Modbus**

A serial communications protocol for connecting industrial electronic

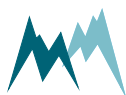

devices.

## N

### **new snow**

recently fallen snow in which the original form of the ice crystals can be recognized NOTE New snow can be measured by use of a snow board

## P

### **perennial snow**

snow persisting for an indefinite time longer than one year NOTE See also seasonal snow and firn

## R

### **RS-485**

A standard defining the signal transmission in serial communication systems.

## S

### **SBP**

Sommer Bus Protocol

### **SDI-12**

Asynchronous serial communications protocol for intelligent sensors (Serial Digital Interface at 1200 baud)

### **seasonal snow**

snow that accumulates during, and lasts, for only one season NOTE See also perennial snow.

### **snow accumulation**

opposite of ablation all processes that add mass to the snow cover, i.e. typically solid and liquid precipitation, ice deposition from atmospheric water vapor, and snow deposited by wind, avalanches, etc.

### **snow avalanche**

mass of snow which becomes detached and slides swiftly down a slope NOTE Large snow avalanches may contain rocks, soil, vegetation, and/or ice

### **snow board**

a specially constructed board used to measure new snow manually

### **snow course**

an established line, or transect, of measurements of SWE across a snow-covered area in a representative terrain, where snow accumulation is not homogeneously distributed in the terrain

### **snow cover**

the accumulation of snow on the ground the areal extent of snow-covered ground NOTE See also snowpack, and fractional snow cover.

### **snow creep**

a continuous, slow downhill movement of a snow layer



**snow crust**

a crisp, firm, outer surface upon snow NOTE Basically, three types of snow crusts exist, formed by 1) the refreezing of surface snow, after melting and/or wetting, which forms a hard layer of snow (sun crust, rain crust, spring crust); 2) the packing of snow into a hard layer by wind action (wind crust, wind slab); and 3) a continuous layer of ice on top of snow formed by freezing of surface water (film crust, ice crust). A snow crust is designated as "breakable" or "unbreakable" according to its ability to support a person on skis.

**snow density**

the mass of snow per unit of volume NOTE Sometimes total and dry snow densities are measured separately. Total snow density encompasses all constituents of snow (ice, liquid water, and air) while dry snow density refers to the ice matrix and air only.

**snow depth**

the total height of the snowpack measured vertically from the base to the snow surface NOTE The slope-perpendicular equivalent of snow depth is the snow thickness

**snow distribution**

spatial and temporal variability of snow cover affected by snowfall, wind speed, elevation, topography, vegetation and ablation

**snow height**

the vertical distance from a base to a specific level in the snow, or to the snow surface NOTE Ground surface is usually taken as the base, but on firn fields and glaciers it refers to the level of either the firn surface or glacier ice. Height is used to denote the position of different snow layers but also of measurements such as snow temperatures relative to the base. In those cases, where only the upper half of the snowpack gets analyzed, the snow surface may be taken as the reference. This should be indicated by using negative coordinate values. Snow depth is the total height of the snowpack.

**snow layer**

a layer of ice crystals with similar size and shape, delimited by two clear layer boundaries

**snow load**

the downward force on an object or structure caused by the weight of accumulated snow



**snow pit**

a pit dug vertically into the snowpack where snowpack stratigraphy and characteristics of individual snow layers are observed  
NOTE See also snow profile

**snow profile**

a stratigraphic record of the snowpack including characteristics of individual snow layers, usually performed in snow pits

**snow redistribution**

distribution of previously deposited snow that was eroded and transported by the wind  
NOTE Redistribution features such as snowdrifts are usually formed from densely packed and friable snow

**snow stake**

instrument for making manual measurements of the snow depth

**snow survey**

the process of determining snow parameters, most often depth and density, at representative points, usually along a snow course

**snow thickness**

the snowpack measured slope-perpendicularly from the base to the snow surface  
NOTE See also snow depth

**snow water equivalent (SWE)**

water equivalent of snow cover term expressing the depth of water that would be obtained by melting the snowpack in a given area  
NOTE The snow water equivalent can represent the snow cover over a given region or a confined snow sample over the corresponding area. It is the product of the snow depth and the snow density divided by the density of water, and is typically expressed in millimetres of water equivalent, which is equivalent to kilograms per square metre or litres of water per square metre.

**snowmelt**

the change of the physical state of snowpack from solid to liquid phase, mainly affected by various meteorological factors (e.g. temperature, air humidity, radiation, wind, rain etc.)

**snowpack**

the accumulation of snow on the ground at a given site and time. It often consists of various layers with different physical and mechanical properties  
NOTE See also snow cover

**solid precipitation**

the solid products of the condensation of water vapor falling from clouds or deposited from air

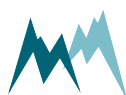

on the ground as snow, snow pellets, snow grains, ice pellets, hoarfrost, rime and hail

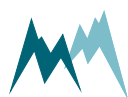

# Index

## R

RS-485 21, 26, 29, 34, 57, 123, 130-133,  
142, 177-178, 182, 186, 210-212, 214,  
229

## S

SDI-12 16, 21, 26, 29, 34, 119, 134-136, 142,  
154, 186-187, 206, 211-212, 225

